



SilkSpace combines LED Light Guide technology and Ledalite's revolutionary MesoOptics technology to deliver discrete, comfortable lighting with great performance and ultra low-glare backed by a UGR of less than 19 across all configurations.

SilkSpace now includes AccuRender technology for the highest color quality at the highest efficacy.

Project: _____
 Location: _____
 Cat.No: _____
 Type: _____
 Line ID: _____ Qty: _____
 Notes: _____

Ordering guide

example: 4224D1STL94068Q1DE

| Family | Size | Version | Configuration | Source | CRI/CCT ¹ | Lumens ¹ |
|-------------------------------|---|-------------------------------------|--|--|--|-------------------------------------|
| 42 | | | | L | | |
| 42 SilkSpace | 22 2'x2' | D1 Standard T-Grid | ST Standalone | L LED | 940 CRI 90, 4000K | 40 4000lm |
| | 14 1'x4' | C1 Standard T-Grid + Chicago Plenum | CR Continuous Row (1'x4' or 2'x4') | | 935 CRI 90, 3500K | 30 3000lm |
| | 24 2'x4' | | | | 930 CRI 90, 3000K | 17 1700lm |
| | | | | | | 68 6800lm 52 5200lm 40 4000lm |
| Optics | Wiring ^{2,3} | Voltage ^{2,3} | Driver ^{2,3} | Option | Systems/Controls ^{4,5} | |
| Q | | | | | | |
| Q Light Guide with MesoOptics | 1 Single Circuit B Single Circuit + Battery Pack | D UNV 120-277V | E Advance Xitanium 0-10V (1% Dim) | P Flex Whip (6') | Leave blank | |
| | | 3 347V | D Advance Xitanium DALI-2 (5% Dim) H Lutron EcoSystem LDE1 (<1% Dim, Fade-to-Black) | D Drywall Trim Kit F Drywall Trim Kit + Flex Whip (6') | | |
| | | D UNV 120-277V | S Advance Xitanium SR (1% Dim) | N No Option P Flex Whip (6') D Drywall Trim Kit F Drywall Trim Kit + Flex Whip (6') | CS Interact Pro scalable wireless sensor with integral daylight & occupancy sensing, advanced grouping with dwell time SB Interact Pro wireless sensor with occupancy, daylight, and environmental sensing capabilities AS Lutron Athena wireless node (RF with daylight and occupancy) VS Lutron Vive (RF with daylight and occupancy) | |

1. Nominal values within a range. Consult photometry data for CRI, color temp, lumens & distribution of chosen configuration.
 2. Not all wiring types are available with all configurations. Consult Ledalite for a complete list of available options.
 3. 347V not available with Battery Pack, GTD, DALI, Lutron EcoSystem or Sensor Ready (SR) drivers or Interact Pro options.
 4. Interact Pro options require separate controls hardware by Signify.
 5. Must order IRT9015 Interact commissioning remote with each Interact Pro system order.

Note: Due to continuing product improvements, Ledalite reserves the right to change the specifications without notice.

DLC Note: Not all product variations listed on this page are DLC qualified. To ensure that a specific model is qualified, visit www.designlights.org/search

SilkSpace recessed

2'x2', 1'x4' & 2'x4'

Dimensions



Size

2'x2' (22)

1'x4' (14)

2'x4' (24)

Cross section view

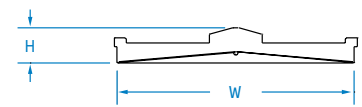
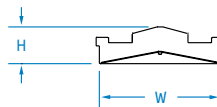
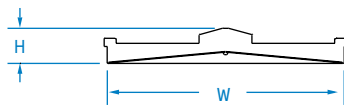

Back view

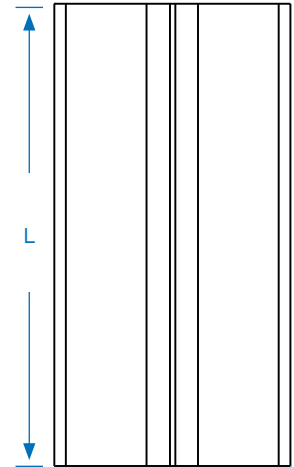
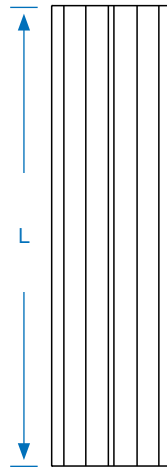
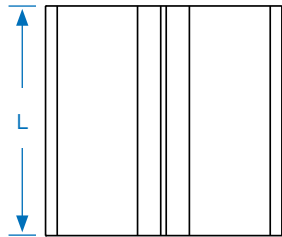

| Size | W | L | H |
|------------|-----------------|------------------|---------------|
| 2'x2' (22) | 23 3/4" [602mm] | 23 1/2" [598mm] | 3 1/2" [90mm] |
| 1'x4' (14) | 11 5/8" [296mm] | 47 1/2" [1208mm] | 3 1/2" [90mm] |
| 2'x4' (24) | 23 3/4" [602mm] | 47 1/2" [1208mm] | 3 1/2" [90mm] |

SilkSpace recessed

2'x2', 1'x4' & 2'x4'

Mounting details

Flat T-Grid

Integrates with most common T-Grid types. Works with 9/16" & 15/16" flat T-Grid ceilings

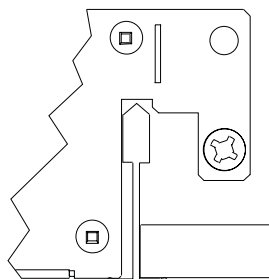

Slot T-Grid

Can be used with slot T-Grid ceilings. For 9/16" slot T-Grid ceilings, fixture will sit 5/16" above bottom of T-Bar.

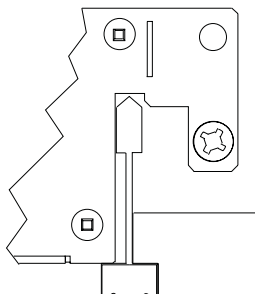

Drywall Trim Kit

The drywall trim kit mounting frame assembly is designed to permit use of grid (NEMA G) fixtures in drywall or ceilings requiring flanges. Finish is white.

Extruded aluminum construction with mitered corners. Includes screws for complete assembly. Available in 2'x2', 2'x4' & 1'x4' sizes.

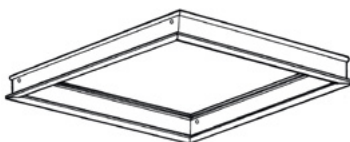

| Drywall Kit Ordering Code | Size |
|---------------------------|-------|
| 300DK02 | 1'x4' |
| 300DK03 | 2'x2' |
| 300DK04 | 2'x4' |

More information available at:

http://docs.ledalite.com/download/pdf/ID-Recessed_Drywall_Kits.pdf

Wood Frame Hanger Wire

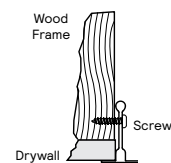

Wood frame and screws supplied by others.

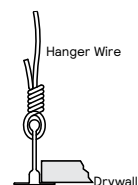

Hanger wires supplied by others.

SilkSpace recessed

2'x2', 1'x4' & 2'x4'

Specifications

Optical System

The optical system is comprised of arrays of LEDs edge lighting a low profile light guide panel. The micro structured surface of the light guide panel optimizes the light extraction creating a homogeneously luminous appearance. Light is then controlled by MesoOptics film suppressing the high-angle light creating an ultra low-glare bat-wing distribution.

Finish

Housing and Frame painted, high quality, powder coated matte white only.

Housing

Sides and center spine: precision aluminum extrusion; end caps, back housing and driver cover: die-formed, 20 gauge cold-rolled steel, pre and post painted. Available in white. Multiple wire entrances are available (top or side) to allow continuous row mounting of fixtures.

Weight

Maximum 28lbs (2x4); 21lbs (1x4); 15lbs (2x2).

Electrical

Factory pre-wired.

Mounting

Fixtures are factory pre-wired and tested for all circuits and emergency battery packs. Compatible with 15/16" lay-in acoustical ceilings using exposed grid suspension (NEMA type G). For 9/16" slot T-grid ceilings, fixture will sit 5/16" above bottom of Tee. Optional drywall kit trim mount can be fastened to a wood frame or with hangar wire. Continuous row mounting not available with drywall kit trim mounts.

Standard Driver

Advance Xitanium 0-10V, 1% dimming.

Advance Xitanium Sensor Ready (SR), 1% dimming (Advance SR Driver is DALI-2 and D4i compatible).

Advance Xitanium DALI-2, 5% dimming.

Lutron EcoSystem LDE1, 1% dimming with Soft-on, Fade-to-Black.

Class 2 rated output.

Consult Ledalite for other available drivers.

Standard Battery Packs

Bodine Battery Pack, 90 min, 10W, Class 2 rated output.

Lumen output = 10W x luminaire efficacy x 1.1. Typical output 1100lm. **Lumen**

Maintenance

LEDs have been tested by the manufacturer in accordance with IESNA LM-80-08. At an ambient temperature of 25°C, the LED lumen maintenance expectation according to IES TM-21-11:

L_{90} (10k) >60,000 hrs (Reported methodology)

Source Color

LEDs rated for color rendering of:
CRI >90 & R9>50

Fixture to fixture color accuracy within:
2 SDCM for Static White luminaires

Wiring

Optional flex whips are supplied in 6' lengths.

Approvals

Certified to UL, CSA, and IES standards. City of Chicago Approved CCEA (version option C1).

Certain product configurations are DesignLights Consortium qualified. Please see the DLC QPL list for exact catalog numbers under DLC Family Code RRRYBO.

www.designlights.org/QPL

Quick Ship

Available for most non-connected configurations upon request. More information available at: www.signify.com/en-us/brands/ledalite/quickship

Warranty

Five-year luminaire limited warranty including LED boards and driver.

www.signify.com/warranties

Environment

Rated for dry & damp locations in operating ambient temperatures of 0-25°C (32-77°F). Many luminaire components, such as reflectors, refractors, lenses, and LEDs are made from various types of plastics which can be adversely affected by airborne contaminants. If sulfur based chemicals, petroleum based products, cleaning solutions, or other contaminants are expected in the intended area of use, consult factory for compatibility. Damage caused by sulfur, chlorine, petroleum based solution or other contaminants are not covered under warranty.

WELL v2 Building Standard

SilkSpace luminaires with MesoOptics contribute towards satisfying the following features under the WELL v2 Building Standard:

L03: When specified with the Tunable White system.

L04: Glare management with all configurations at <19 UGR.

L06: Brightness management with batwing distributions allowing for even lighting within a space, while spacing the fixtures wider apart than a typical recessed luminaire product.

L07: AccuRender CRI 90 standard LED boards with high performance Advance drivers (or optional drivers) to manage color quality and flicker

L08: When specified with Interact or when tied to a 3rd party control system.

SilkSpace recessed

2'x2', 1'x4' & 2'x4'

Wireless Controls Options

Interact Pro scalable sensor for Foundation, Advanced & Enterprise tiers (CS an evolution of SpaceWise):

- CS is a connected sensor with integral occupancy and daylight sensing and supports wireless mesh connectivity.
- The sensor works in the Foundation mode (similar to SpaceWise) when configured without a gateway or in an Interact Pro Advanced or Enterprise mode if a compatible gateway is used.
- Interact Pro includes an App, a portal and a broad portfolio of wireless luminaires, lamps and retrofit kits all working on the same system.
- Startup is implemented via Interact Pro App (Android or iPhone) & Bluetooth connectivity. The App provides flexibility to choose between a gateway or non gateway mode for setup.
- Setup with the gateway requires wired internet access to the gateway. It is possible to add a gateway at a later point.
- Prepare project configuration steps remotely and use IRT9015 remote onsite to identify and group devices together.
- Compatible with UID8451/10 wireless dimmer switch, SWS200 wireless scene switch, wireless Occ sensor (OCC SENSOR IA CM IP42 WH 10/1) and wireless Day/Occ sensor (OCC MULTI SENSOR IA CM WH 10/1).
- For more information on Interact Pro visit: www.interact-lighting.com/interactproscalablesystem

Emergency Options (R):

- Power Sensing (Factory default) – Recommended
- UL924 option requires unswitched power sense line, absence of voltage on the normal circuit triggers luminaire to 100% output.
- Power Interruption Detection (Field option)
- Detects AC power interruption >30ms triggers 90 minute emergency mode with luminaire at 100% output.

Interact Pro scalable sensor bundles for Enterprise tier (SB):

- SB option, in addition to occupancy and daylight sensing, supports advanced IoT capabilities such as people estimation analysis, desk level temperature & humidity sensing, noise classification, and BLE beacon.
- Compatible with UID8451/10 wireless dimmer switch, SWS200 wireless scene switch, wireless Occ sensor (OCC SENSOR IA CM IP42 WH 10/1) and wireless Day/Occ sensor (OCC MULTI SENSOR IA CM WH 10/1).
- Use Interact software and insights to increase building efficiency, achieve building wide integration and optimize space through occupancy analytics.
- Requires compatible Gateway and internet connectivity for commissioning. For more information, visit: www.interact-lighting.com/office

Lutron Athena and Vive (AS and VS):

- Lutron Athena (AS = AWNS) and Lutron Vive (VS = VDO) integral fixture control available with Advance SR drivers. See Lutron website for additional details and specs: <https://commercial.lutron.com/>

Wired Controls Options

Interact Office Wired PoE (IO & SB):

- PoE based IoT connected lighting solution for large enterprises that span across multiple floors, buildings and require multiple gateways.
- Use Interact software and insights to increase building efficiency, achieve building wide integration and optimize space through occupancy analytics.
- Integral sensor option for occupancy sensing (PIR) and/or daylight harvesting available for additional energy savings.
- SB option, in addition to occupancy and daylight sensing, supports advanced IoT capabilities such as people estimation analysis, desk level temperature & humidity sensing, noise classification, and BLE beacon.
- Optional integral emergency controller and battery pack provides backup lighting in the case of a power outage. Test switch and indicator light mounted on the chassis.
- Emergency battery has a 3 month pre-installed shelf life, and must be stored and installed in environments of -20°C to 30°C (-4F to 86F) ambient, and 45-85% relative humidity.
- For more information on Interact Office Wired visit: www.interact-lighting.com/office

Note: Signify Interact Office Luminaires are not sold individually and are only compatible with Signify's Interact Office control system & software. The system requires a compatible back-end IT infrastructure for normal operations, please consult your Signify representative for additional information.

Tunable White:

- Tunable White is available in Interact Office Wired PoE luminaires. Other control options for Tunable White with DALI (DT6 or DT8), 0-10V, Lutron T Series or DMX control are available via an Engineered-to-Order (ETO) request.
- Signify tunable white solutions are designed to help maximize the influence of lighting on your daily life.
- Dynamic behaviors via scheduled lighting recipes mimicking daylight patterns or supporting biorhythms.
- Scene setting via lighting pre-sets based on various combinations of lighting color temperature and intensity.

Interact Pro scalable sensor option codes across Genlyte product lines

| | Evokit | Day-Brite | Ledalite | Lightolier |
|---|--------|-----------|----------|--------------------------|
| Zigbee + Bluetooth + Sensing | SWZCS | SWZCS | CS | SBA accessory (external) |
| Zigbee + Bluetooth | RADIO | RADIO | RA | RA |
| Zigbee + Bluetooth + Sensing + Environmental data | IAOSB | IAOSB | SB | SB |
| Zigbee + Highbay + Sensing | - | SWZCSH | - | - |

SilkSpace recessed

2'x2', 1'x4' & 2'x4'

Functionalities overview

| | Interact Pro scalable system | | |
|--|------------------------------|----------|------------|
| | Foundation | Advanced | Enterprise |
| Dimming, grouping, and zoning | ✓ | ✓ | ✓ |
| Bluetooth and ZigBee enabled | ✓ | ✓ | ✓ |
| Motion sensing and daylight harvesting | ✓ | ✓ | ✓ |
| Integration with 0-10V and phase dimming fixtures | ✓ | ✓ | ✓ |
| Code compliance | ✓ | ✓ | ✓ |
| Granular dimming and dwell time | ✓ | ✓ | ✓ |
| New Correlated color temperature (CCT) tuning by switch | ✓ | ✓ | ✓ |
| New Support for sensor-based Tunable White luminaires | ✓ | ✓ | ✓ |
| Energy reporting and monitoring | | ✓ | ✓ |
| Scheduling | | ✓ | ✓ |
| Demand response | | ✓ | ✓ |
| BMS integration (BACnet) | | | ✓ |
| Floor plan visualization | | | ✓ |
| IoT sensors for wellness | | | ✓ |
| IoT Apps for productivity | | | ✓ |

Currently supported maximum system size

To be able to design the lighting system correctly for the customer, it is important to know the prime characteristics of the system, its possibilities and limitations.

| System level | |
|--|---------------------|
| Total number of gateways | Unlimited |
| Total number of devices | 200 per network |
| • luminaires with integrated sensors | 150 |
| • smart TLEDS | 150 |
| Total number of ZGP devices (sensors and switches) | 50 |
| • sensors | 30 |
| • switches | 50 |
| • zones and groups | 64 |
| Group level | |
| Recommended number of lights | 40 (recommended 25) |
| Number of ZGP devices | 5 |
| Number of scenes | 16 |

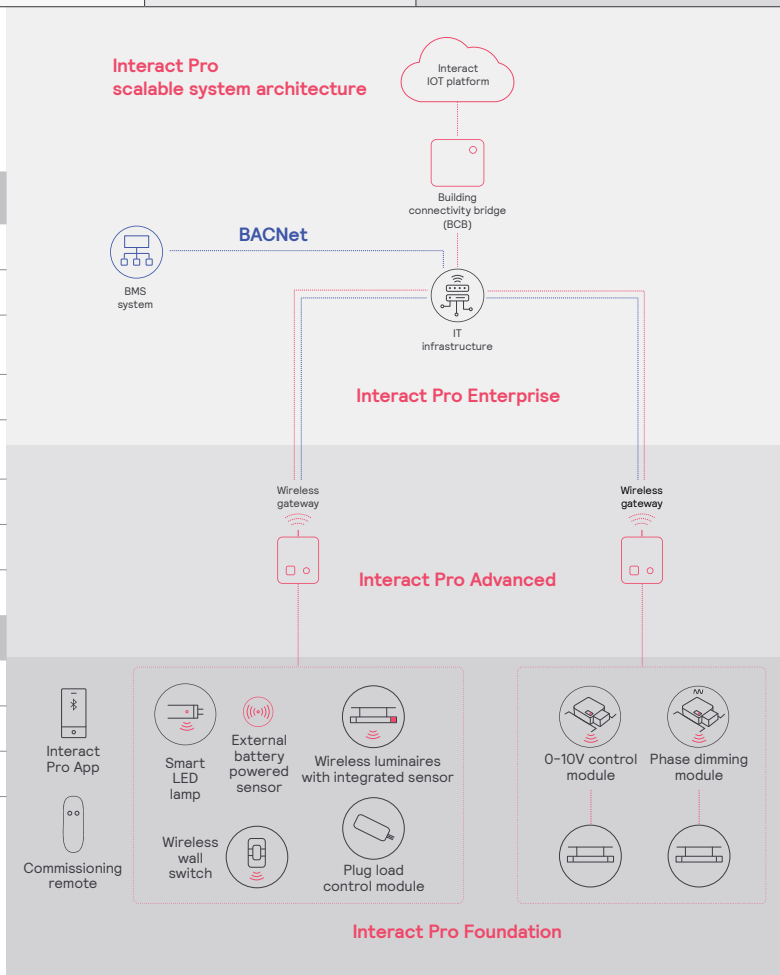

SilkSpace recessed

2'x2', 1'x4' & 2'x4'

Colorimetry

SilkSpace Performace with MesoOptics (42)

| Nominal CRI & CCT | | CRI 90, 3000K | CRI 90, 3500K | CRI 90, 4000K |
|-----------------------------|--------------------|---------------|---------------|---------------|
| CIE 013.3-1995 ¹ | CRI R _a | 93 | 92 | 92 |
| | R _s | 53 | 49 | 54 |
| | G _a | 97 | 96 | 96 |
| | C ₉ | 92 | 91 | 92 |
| IES TM-30-18 ² | R _f | 92 | 91 | 90 |
| | R _{f,h1} | 90 | 88 | 89 |
| | R _g | 98 | 98 | 97 |
| | R _{cs,h1} | -6% | -6% | -6% |
| MDER ³ | | 0.47 | 0.54 | 0.61 |

- Color Rendering Index (CRI Ra) and Strong Red (R9) are calculated in accordance with CIE 013.3-1995. Color Gamut index (Ga) and red chroma Index (C9) are CIE based properties using the Global Lighting Association's calculation tool.
- Fidelity Index (Rf), Red Fidelity Index (Rf,h1), Gamut Index (Rg), and Red Local Chroma Shift (Rcs,h1) are calculated in accordance with IES TM-30-18.-18.
- Melanopic Daylight Efficacy Ratio (MDER) is the measure for "spectral melanopic efficiency" as defined in CIE S 026-2018.

Photometry

SilkSpace Performace with MesoOptics (42)

| Nominal CRI & CCT | | CRI 90, 3000K | | | | | CRI 90, 3500K | | | | | CRI 90, 4000K | | | | |
|------------------------------|-----------|------------------------|-----------------------------|------------------|-------------------|----------|------------------------|-----------------------------|------------------|-------------------|----------|------------------------|-----------------------------|------------------|-------------------|----------|
| Size & Nominal Lumen Package | Watts (W) | Flux (lm) ¹ | Efficacy (LPW) ¹ | UGR ² | Photometry Report | IES File | Flux (lm) ¹ | Efficacy (LPW) ¹ | UGR ² | Photometry Report | IES File | Flux (lm) ¹ | Efficacy (LPW) ¹ | UGR ² | Photometry Report | IES File |
| 2'x2' - 4000lm | 36.9 | 3825 | 104 | 18 | PDF | IES | 3990 | 108 | 18 | PDF | IES | 4006 | 109 | 18 | PDF | IES |
| 2'x2' - 3000lm | 27.3 | 2871 | 105 | 17 | PDF | IES | 2991 | 110 | 17 | PDF | IES | 3004 | 110 | 17 | PDF | IES |
| 2'x2' - 1700lm | 15.5 | 1628 | 105 | 15 | PDF | IES | 1698 | 110 | 15 | PDF | IES | 1699 | 110 | 15 | PDF | IES |
| 1'x4' - 4000lm | 35.0 | 3832 | 110 | 18 | PDF | IES | 3995 | 114 | 18 | PDF | IES | 4002 | 114 | 18 | PDF | IES |
| 1'x4' - 3000lm | 26.6 | 2884 | 108 | 17 | PDF | IES | 3007 | 113 | 17 | PDF | IES | 3008 | 113 | 17 | PDF | IES |
| 1'x4' - 1700lm | 15.6 | 1630 | 105 | 15 | PDF | IES | 1700 | 109 | 15 | PDF | IES | 1699 | 109 | 15 | PDF | IES |
| 2'x4' - 6800lm | 57.1 | 6516 | 114 | 17 | PDF | IES | 6794 | 119 | 18 | PDF | IES | 6822 | 120 | 18 | PDF | IES |
| 2'x4' - 5200lm | 43.1 | 4979 | 116 | 16 | PDF | IES | 5191 | 120 | 17 | PDF | IES | 5206 | 121 | 17 | PDF | IES |
| 2'x4' - 4000lm | 33.3 | 3828 | 115 | 16 | PDF | IES | 3991 | 120 | 16 | PDF | IES | 3996 | 120 | 16 | PDF | IES |

- Luminaire photometry has been conducted in accordance with IES LM-79-08. IES files can be downloaded by clicking the links in the table above, or online at ledalite.com. Luminaires with finishes other than standard white may result in a drop in flux and efficacy.
- Unified Glare Rating (UGR) is calculated in accordance with CIE 117-1995. Reference conditions of 4Hx8Hx1H and reflectances of 70/50/20% have been applied using the procedure described in CIE 190-2010.

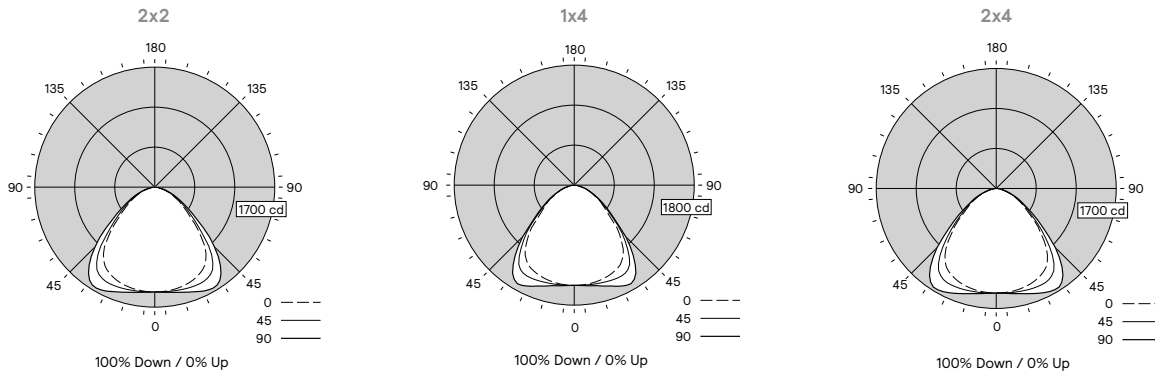

Photometric data shown is for 4000lm, CRI 90, 3500K configurations.



© 2023 Signify Holding. All rights reserved. The information provided herein is subject to change, without notice. Signify does not give any representation or warranty as to the accuracy or completeness of the information included herein and shall not be liable for any action in reliance thereon. The information presented in this document is not intended as any commercial offer and does not form part of any quotation or contract, unless otherwise agreed by Signify.

Signify North America Corporation
400 Crossing Blvd, Suite 600
Bridgewater, NJ 08807
Telephone: 800-555-0050

Signify Canada Ltd.
281 Hillmount Road,
Markham, ON, Canada L6C 2S3
Telephone: 800-668-9008

All trademarks are owned by Signify Holding or their respective owners.