

**INSTALLATION INSTRUCTIONS:
HFW390 WALL MOUNT****ASSEMBLY INSTRUCTIONS:**

1. LOOSEN (3) SET SCREWS AND REMOVE END CAP FROM ARM. SET PARTS ASIDE.
2. REMOVE MOUNTING BOLTS, LOCK WASHERS, MOUNTING PLATE, AND HOLE CAPS FROM PACKAGING.
3. INSERT MOUNTING PLATE INTO BOTTOM OF ARM, ORIENTED AS SHOWN AT RIGHT.
4. FEED WIRE THROUGH CENTER HOLE OF MOUNTING BRACKET AND BACK OUT THROUGH THE ARM AS SHOWN ABOVE.
5. INSERT MOUNTING BOLTS, WITH LOCK WASHERS, AS SHOWN. SCREW THEM TIGHTLY INTO WALL BRACKET.
6. GENTLY TAP HOLE CAPS INTO PLACE. REPLACE END CAP AND SET-SCREW IN PLACE.
7. MOUNT ASSEMBLED ARM TO WALL.

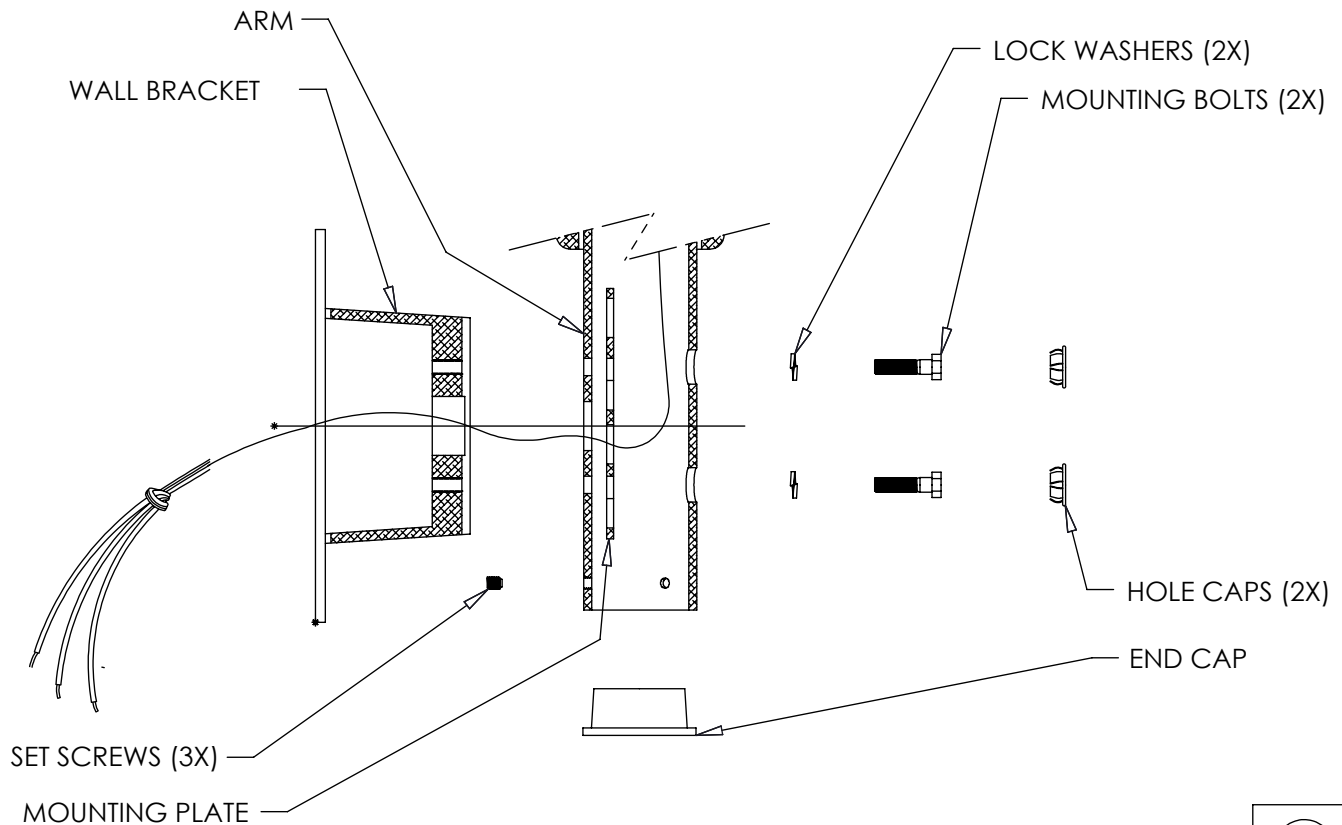

ORIENT MOUNTING PLATE AS SHOWN. MOUNTING BOLTS ARE TO GO THROUGH KEY-SLOTS.

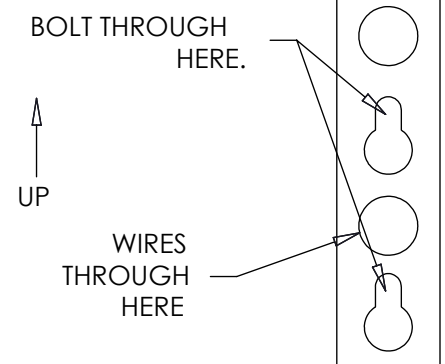

This fixture is intended for installation in accordance with the National Electrical Code and local code specifications. Failure to adhere to these codes and instructions may result in serious injury and/or damage to the ballast and void the warranty. These instructions do not purport to cover all details or variations in equipment, nor to provide for every possible contingency related to installation, operation, maintenance, or mounting situation. Should specific problems occur that are not addressed by these instructions, contact your Sales Representative or distributor for assistance. Retain these instructions for future reference.

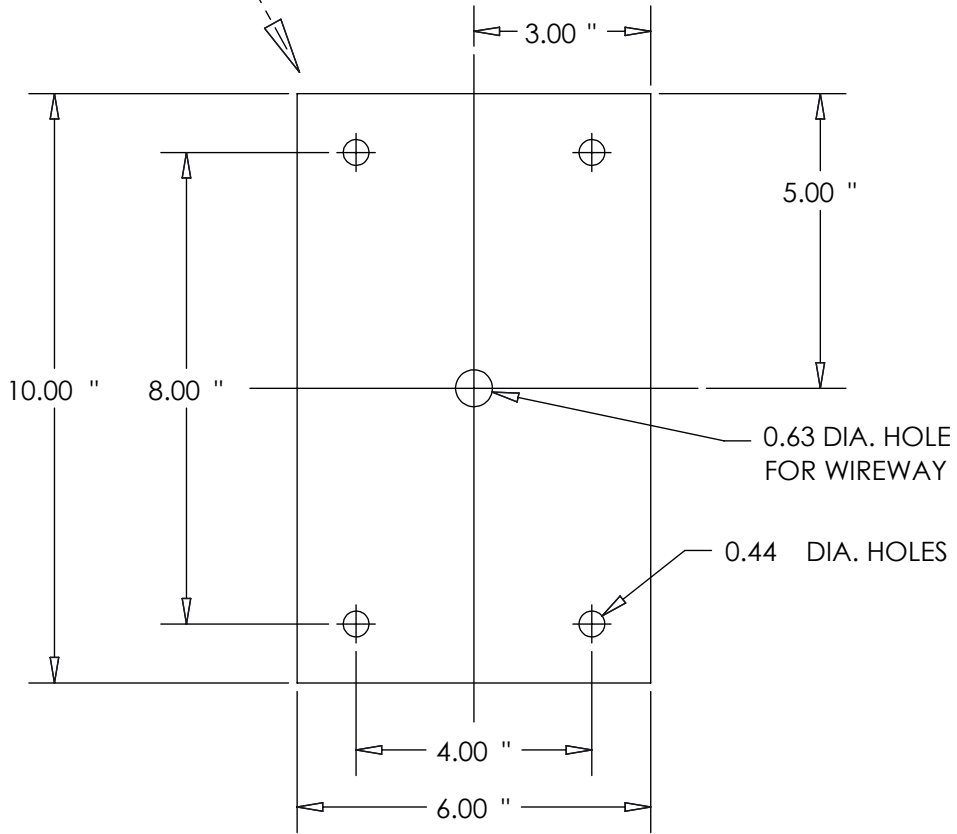
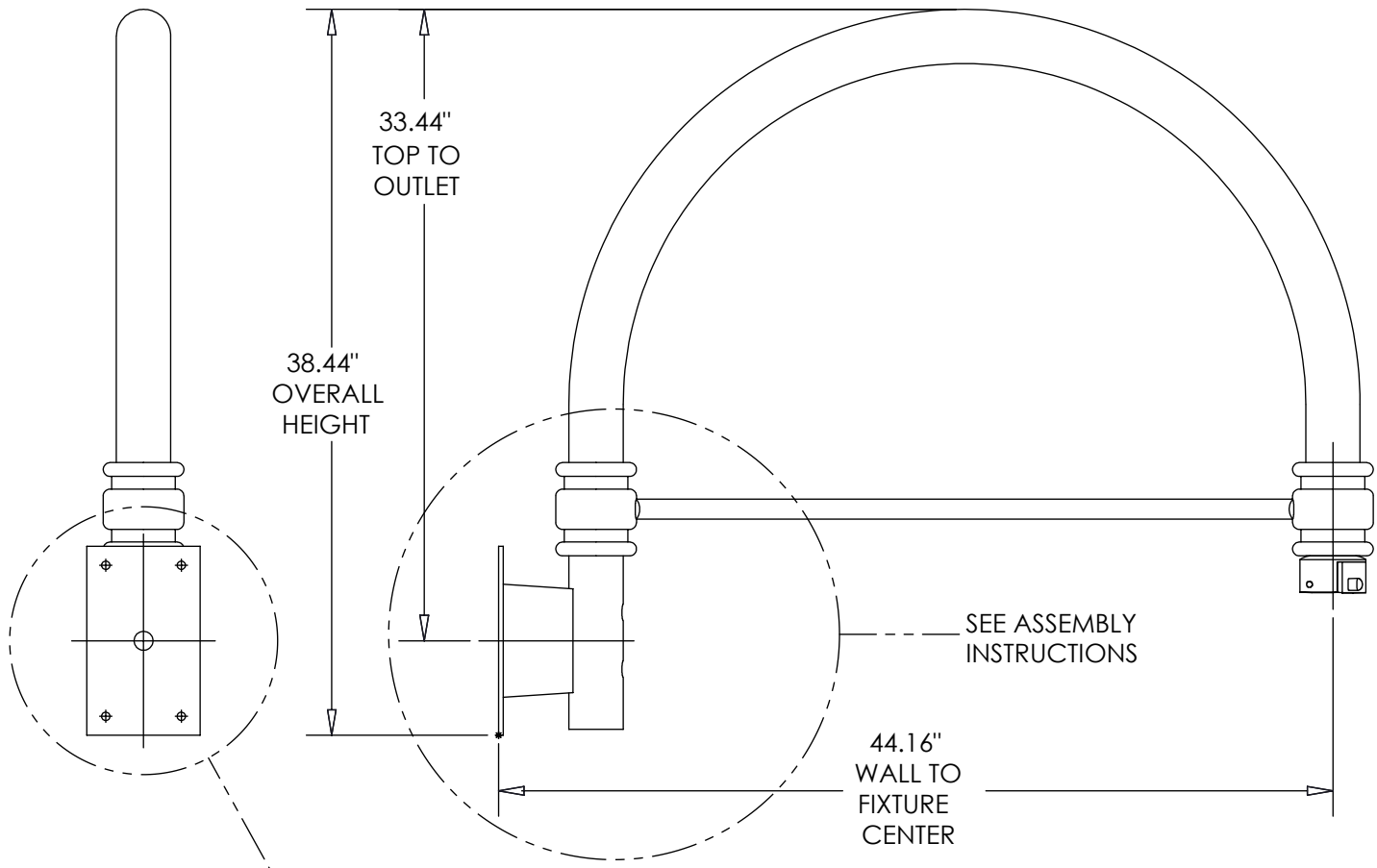

HABCO

by **Signify**

Signify North America Corporation
200 Franklin Square Drive
Somerset, NJ 08873
Telephone 855-486-2216

Signify Canada Ltd.
281 Hillmount Road,
Markham, ON, Canada L6C 2S3
Telephone 800-668-9008

INSTALLATION INSTRUCTIONS: HFP310, HFP320 POST MOUNT

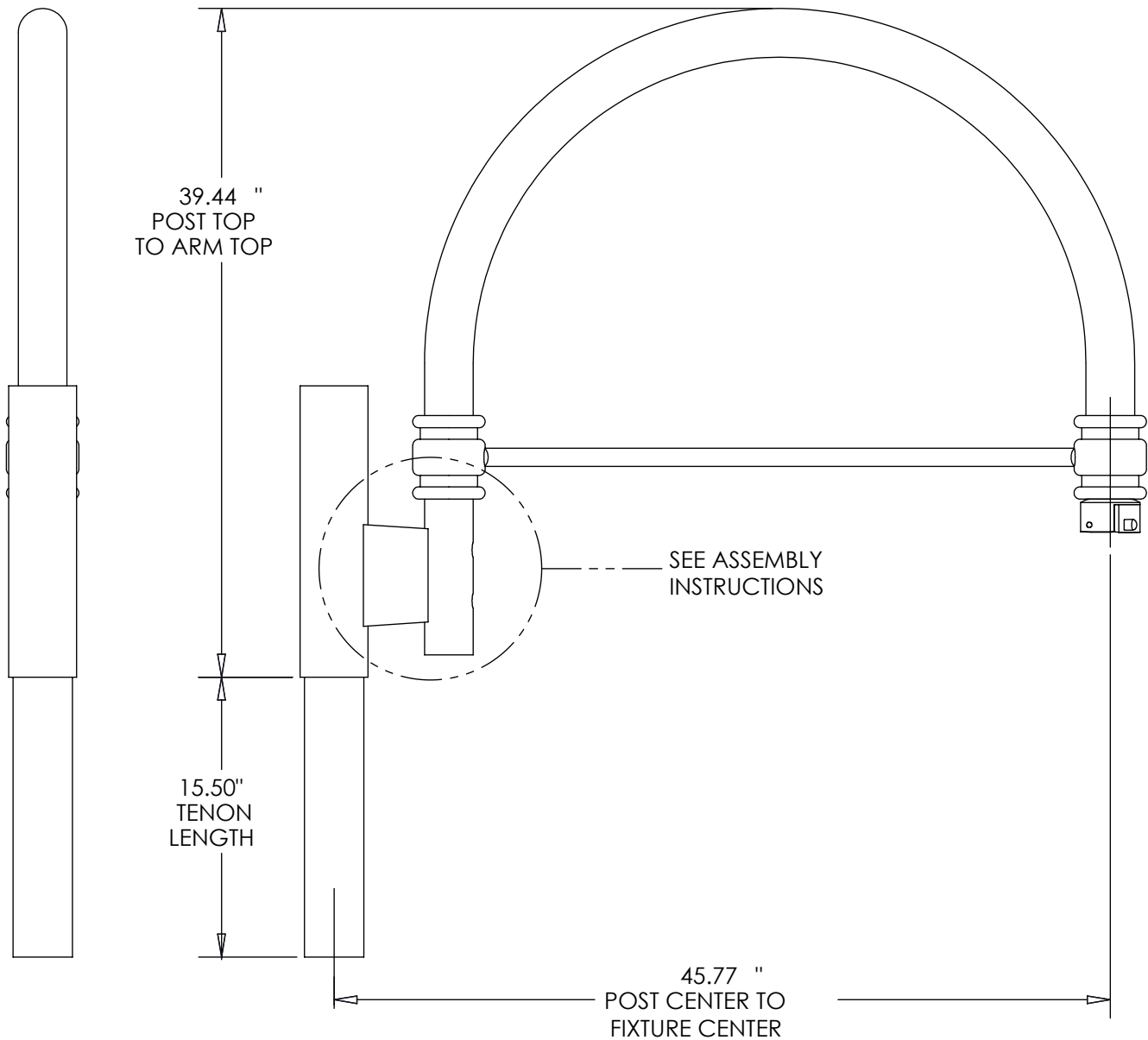

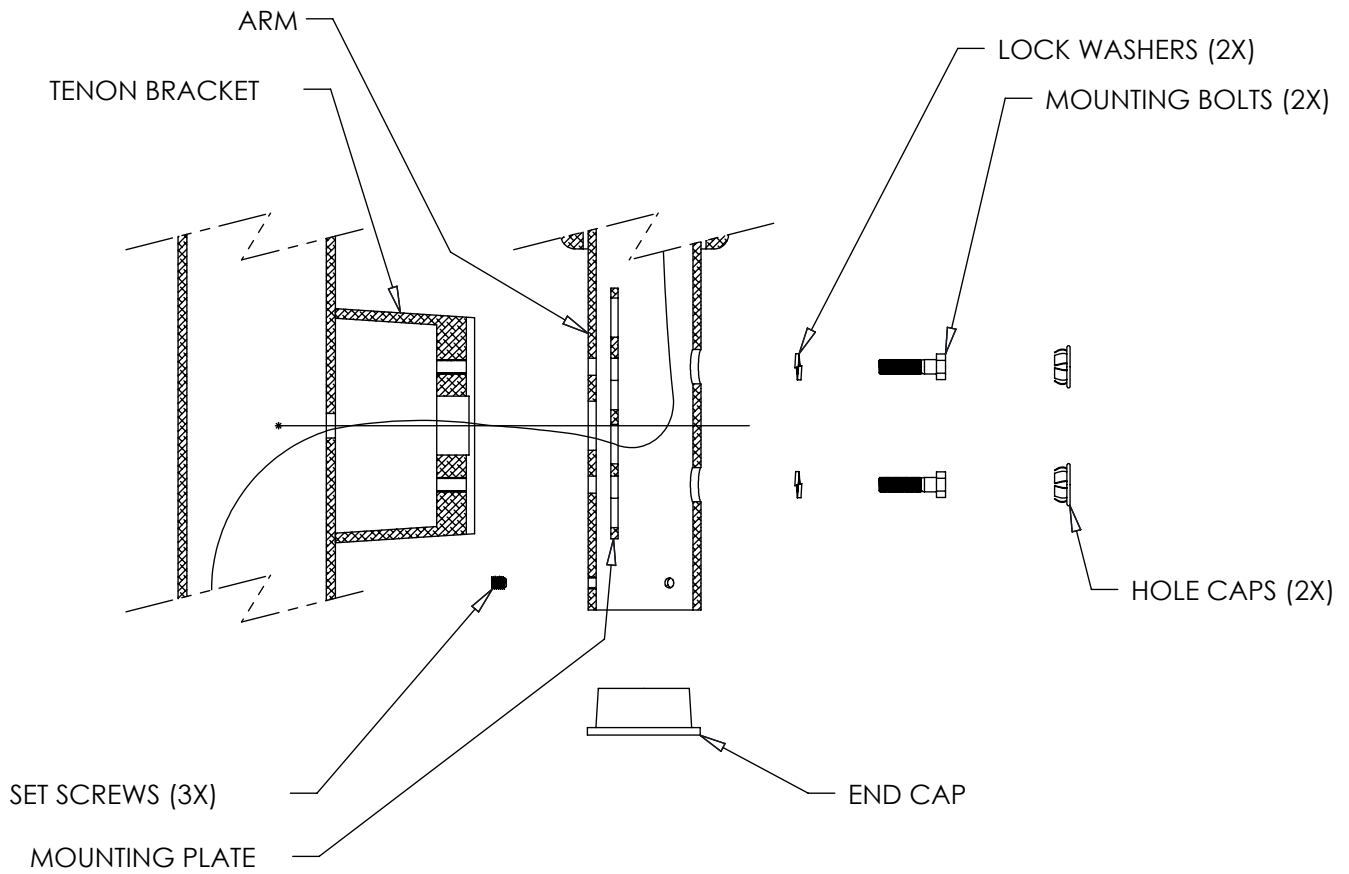

ASSEMBLY INSTRUCTIONS:

1. LOOSEN (3) SET SCREWS AND REMOVE END CAP FROM ARM. SET PARTS ASIDE.
2. REMOVE MOUNTING BOLTS, LOCK WASHERS, MOUNTING PLATE, AND HOLE CAPS FROM PACKAGING.
3. INSERT MOUNTING PLATE INTO BOTTOM OF ARM, ORIENTED AS SHOWN AT RIGHT.
4. FEED WIRE THROUGH CENTER HOLE OF MOUNTING BRACKET AND BACK OUT THROUGH THE ARM AS SHOWN ABOVE.
5. INSERT MOUNTING BOLTS, WITH LOCK WASHERS, AS SHOWN. SCREW THEM TIGHTLY INTO TENON BRACKET.
6. GENTLY TAP HOLE CAPS INTO PLACE. REPLACE END CAP AND SET-SCREW IN PLACE.
7. MOUNT ASSEMBLED ARM ON POST TOP.

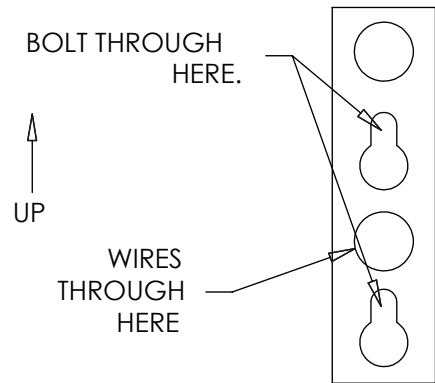

ORIENT MOUNTING PLATE AS SHOWN. MOUNTING BOLTS ARE TO GO THROUGH KEY-SLOTS.