



Project: _____

Location: _____

Cat.No: _____

Type: _____

Qty: _____

Notes: _____

OmniSpot LED Track Heads are designed to meet the most demanding retail lighting challenges through sleek and discrete aesthetics while providing a high center beam candlepower and efficacy performance. OmniSpot allows for less than 1" of space between the track head and track in the ceiling.

Now including AccuRender technology for the highest color quality at the highest efficacy.

Complete unit = Fixture + Reflector + Optional Accessories

Fixture

example: LCL06930WHITE

Series	Adapters	Lumens	CRI/CCT	Finishes	Dimming
LC					TE
LC OmniSpot Track Heads	L Lightolier H Halo J Juno	06 600lm 10 1000lm 20 2000lm	927 90CRI / 2700K 930 90CRI / 3000K 935 90CRI / 3500K 940 90CRI / 4000K LED Color Recipes CW30 90CRI / 3000K Crisp White PW30 90CRI / 3000K Premium White PC30 90CRI / 3000K Premium Color	AL Aluminum BK Matte Black WH Matte White	TE Trailing Edge/Leading Edge

Reflectors¹ (order separately)

example: LLMRNS

Series	Beam spreads
LLM OmniSpot Small (600lm & 1000lm)	RNS 12° Narrow Spot ²
LLAV11 OmniSpot Medium (2000lm)	RS 18° Spot RNF 23° Narrow Flood RF 36° Flood

- Narrow Spot Reflector LLMRNS has a 12° beam, LLAV11RNS has a 11° beam.
- Beam spread is 16° when PremiumColor is used with LLMRNS.
- Aperture ring included on the fixture can hold a maximum of 1 film and 1 snoot.
- Accessory holder can hold a maximum of 1 hex cell, 1 film, and 1 snoot.
- Hex cell needs to be ordered with an Accessory holder.

Optional Accessories^{3,4,5} (order separately)

example: LC10AHWH

Series	Finishes
Accessory holders⁴	
LC10AH OmniSpot Small (600lm & 1000lm)	AL Aluminum
LC20AH OmniSpot Medium (2000lm)	WH Matte White BK Matte Black
Snoots	
LC10SN OmniSpot Small (600lm & 1000lm)	AL Aluminum
LC20SN OmniSpot Medium (2000lm)	WH Matte White BK Matte Black
Diffusion films	
LC10 OmniSpot Small (600lm & 1000lm)	SF Soft Focus
LC20 OmniSpot Medium (2000lm)	FR Frosted Etched LS Linear Spread SY Symmetrical Spread
Hex cell louvers⁵	
7472 OmniSpot Small (600lm & 1000lm)	
LC20HC OmniSpot Medium (2000lm)	

LC OmniSpot LED

Track Heads (600lm, 1000lm & 2000lm)

Features

- LED board:** COB LED.
- Integrated housing heat sink:** Impact extrusion aluminum maintains LED junction temperature for min of 90,000 hr lifetime at 70% lumen maintenance.
- Track attachment fitting:** Locking lever for mechanical/electrical connection.
- Aperture ring:** Included with luminaire. Die cast aluminum, powder coat to match housing. Tool-less access to reflector and install accessories. Accepts a maximum of 1 film and 1 snoot.
- Mounting arm:** Die-cast aluminum.
- Movable brass contact:** Brass extends for connection to 2nd circuit (Advent track only).
- Finishes:** Powder coated.
- Pivot mounts:** Allows for 350° horizontal. Vertical rotation of +/- 90° from vertical aim to the floor.
- Interchangeable reflector optics:** High efficiency metalized coating providing up to 98% total reflectivity for optimal light quality, beam control and visual punch. Lens attached to reflector which protects reflector finish and LEDs from contamination. Reflectors sold separately, and offer tool-less install for quick field customization.

- Crisp White:** Available in 90CRI/3000K only, our 90CRI CrispWhite technology combines the warm, saturated colors of high CRI with crisp and vibrant whites. The small form factor and high quality of light make this an impactful option for retail display areas.
- Premium White:** Available in 90CRI/3000K only, the new benchmark in retail fashion, delivering stronger, brighter whites via the best technology in the market, but with minimal compromise on energy savings.
- PremiumColor:** Available in 90CRI/3000K only, provides vivid and robust colors that pop while maintaining a strong ambient white and bold black balance in any space. This LED technology is sure to add positive energy to varying application needs.

Accessories

OmniSpot LED track lighting offers a full range of high performance accessories for tinting, coloring and shaping of the light beam. All accessories are designed to attach easily. A complete accessory consists of a size and series suffix.

Mounting

Compatible with all Monopoint, Multipoint, recessed track, suspension track, as well as Basic, Advent track systems. Can be wall mounted vertically or horizontally. Cannot be used with extension wands.

Dimming Compatibility

SR400RPC120	Philips Sunrise (100 - 5%)
SELV-300P	Lutron Skylark (100-7%)
DVELV-300P	Lutron Diva (100-7%)
6615-P	Leviton Decora (100-12%)

Electrical

Electronic power supply
Input voltage: 120V, 60Hz
Input power: 6W & 12W
Best Efficacy: 116lm/W
High power factor: >0.9
CRI: 90 (typical)

Labels

cULus Listed. 5 year warranty.
ENERGY STAR® certified (excluding Crisp White, Premium White, and Premium Color configurations).
Accessories are not Energy Star qualified.

Dimensions Small (600lm & 1000lm)

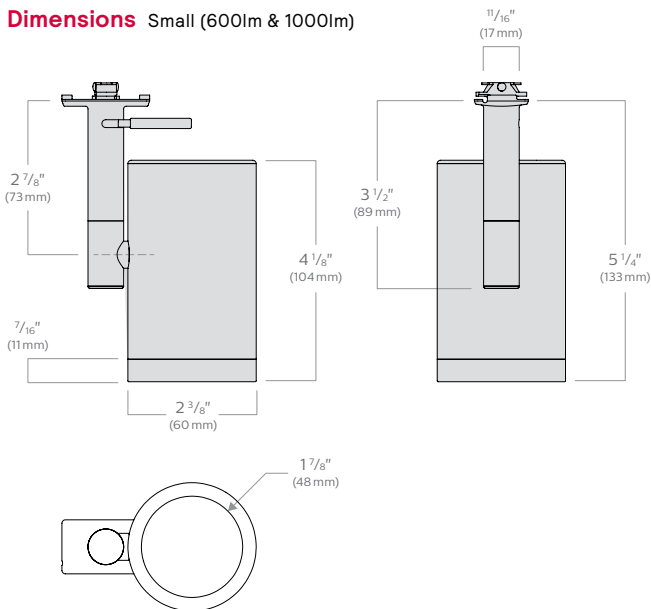

Dimensions Medium (2000lm)

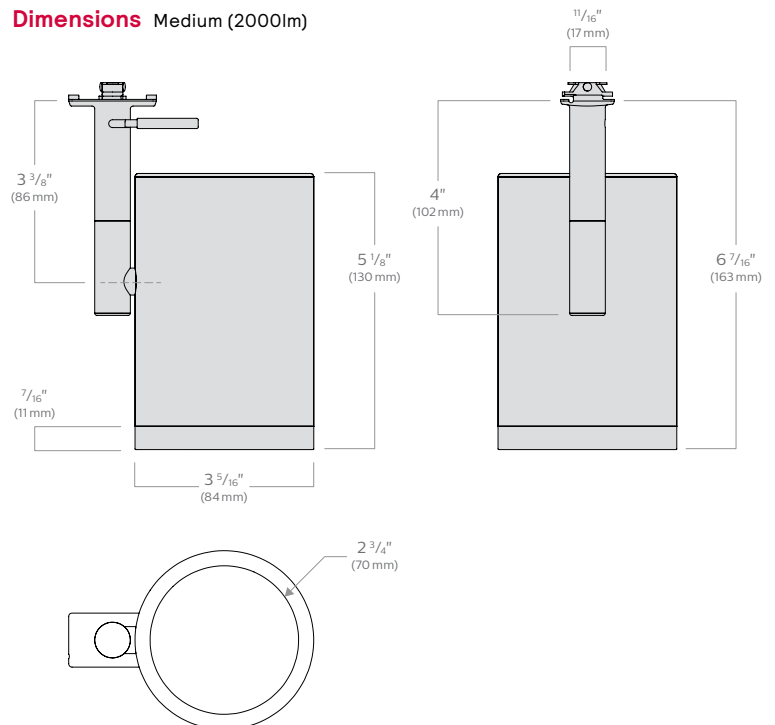

LC OmniSpot LED

Track Heads (600lm, 1000lm & 2000lm)



AccuRender Technology (CRI 90+)

The right light brings colors to life. Our new AccuRender technology helps ensure colors are rendered more accurately and consistently, while doing so as efficiently as CRI 80 products.



Standard CRI 80
Good color rendering and high efficacy



Standard CRI 90
Better color rendering and low efficacy



AccuRender
Best color rendering, color preference and high efficacy

Enjoy design flexibility

Full range of products and options:

- Available soon in across Lightolier portfolio for application flexibility
- Multiple color temperatures (CCTs) and lumen packages offered

Promote savings

High efficacy, with no penalty:

- Energy efficacy compares well to conventional 80 CRI
- Up to 25% more energy savings vs competitor 90 CRI¹
- Helps meet Title 24 requirements

Show your true colors

High color rendering:

- True to life colors to help energize your environment and render better flesh tones critical for healthcare hospitality and retail applications.
- R_a up to 94 CRI
- R₉ up to 67 CRI
- G_a up to 99 CRI
- C₉ up to 94 CRI
- R_f up to 92 TM-30
- R_{r,hi} up to 91 TM-30
- R_g up to 100 TM-30
- R_{cb,hi} up to -5% TM-30

Achieve color balance

Best in class color consistency:

- Promote aesthetic harmony in your space with ≤ 2 SDCM

LED Color Recipes

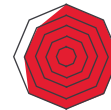
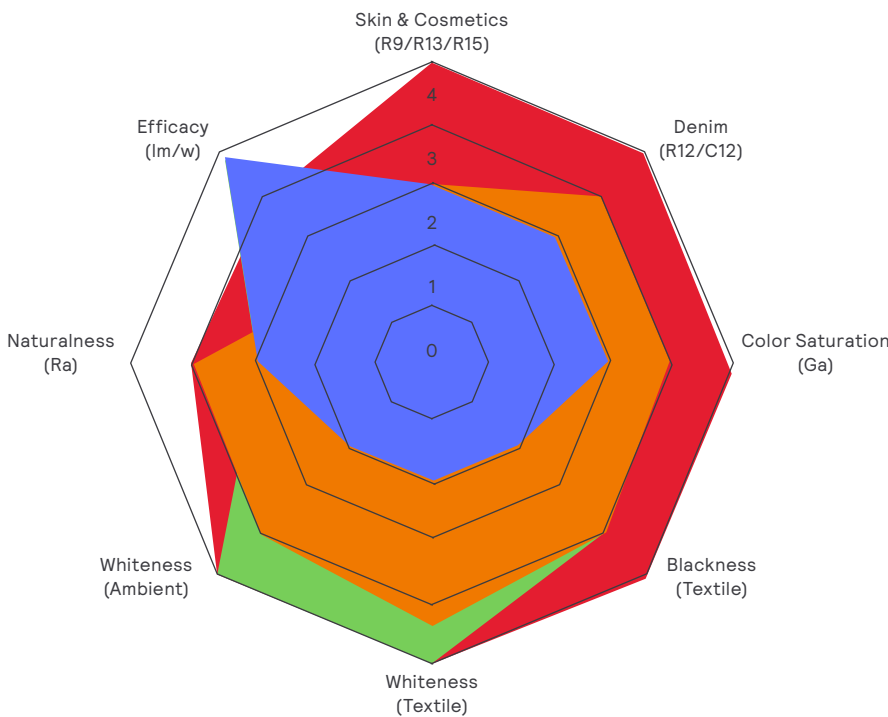

Crisp White

Dial-up the drama of your display. Highlight the variances in white tones, add contrast to blacks and create a real pleasing sparkle effect while retaining warm skin tones.

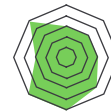

Premium White

The new benchmark for retail fashion. Delivering stronger and brighter whites via the best lighting technology on the market with minimal compromise to energy savings.



Premium Color

Enhance the contrast between colors and whites to achieve new depths of color rendering for a vibrant saturated fashion-forward visual experience that won't affect the atmosphere and will have a positive effect on energy efficiency.

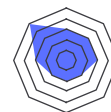

Standard Color

Standard CRI 90

LC OmniSpot LED

Track Heads (600lm, 1000lm & 2000lm)

Accessories (ordered separately)



Components

1. Cylinder housing
2. Reflector optics
3. Diffusion/special films
4. Hex cell louver
5. Snoot
6. Aperture Ring

Hex cell louvers

7472
2" dia.

LC20HC
3" dia.

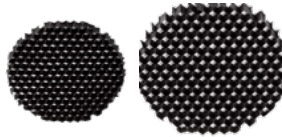

Hex Cell Louvers: Order accessory holder to retain louver. Reduction in light of 45% (only available in matte black).

Snoot

LC10SN
2" dia.

LC20SN
3" dia.



Diffusion films

LLAV11 = 3 1/8" dia. LLAV12 = 4 3/4" dia.

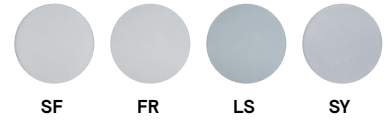

Soft Focus (SF): Only slightly removes beam's punch while softening edges, slightly widens beam, light reduction of about 10%.

Frosted Etched (FR): Increased hiding, smoothing and blending of LED source, takes narrow spot and changes it to about a medium beam distribution, light reduction about 15 -20%.

Linear Spread (LS): Asymmetrical beam-elongating, creates an elliptical pattern, takes narrow spot and changes it to about 15° x 50° beam angles.

Symmetrical Spread (SY): Widens the beam of light in all directions, more pronounced widening effect compared to Solite or frosted, creating larger beam spreads while also softening edges, takes narrow spot and changes it to about 40° beam angle, light reduction of about 20 -25%.

Finishes Small (600lm & 1000lm)



Finishes Medium (2000lm)







LC OmniSpot LED

Track Heads (600lm, 1000lm & 2000lm)

Photometry Small (600lm)



Beam Spread	Color Temp (CCT)	Beam Angle (FWHM)	Flux (lm)	CBCP	Energy (W)	Efficacy (lm/W)	CRI	R9
Narrow Spot (RNS) 	2700K	12°	583	7276	5.9	99	94	57
	3000K	12°	626	7810	5.9	106	94	62
	3500K	12°	677	8447	5.9	115	92	52
	4000K	12°	686	8550	5.9	116	93	60
	Crisp White	12°	502	6255	5.9	85	96	67
	Premium White	12°	640	7988	5.9	109	92	50
	Premium Color	12°	595	7422	5.9	101	94	78
Spot (RS) 	2700K	18°	583	3748	5.9	99	94	57
	3000K	18°	625	4023	5.9	106	94	62
	3500K	18°	676	4351	5.9	115	92	52
	4000K	18°	685	4404	5.9	116	93	60
	Crisp White	18°	501	3222	5.9	85	96	67
	Premium White	18°	639	4114	5.9	108	92	50
	Premium Color	18°	594	3823	5.9	101	94	78
Narrow Flood (RNF) 	2700K	23°	577	2577	5.9	98	94	57
	3000K	23°	620	2766	5.9	105	94	62
	3500K	23°	670	2992	5.9	114	92	52
	4000K	23°	678	3029	5.9	115	93	60
	Crisp White	23°	496	2216	5.9	84	96	67
	Premium White	23°	634	2829	5.9	107	92	50
	Premium Color	23°	589	2629	5.9	100	94	78
Flood (RF) 	2700K	36°	575	1449	5.9	97	94	57
	3000K	36°	617	1555	5.9	105	94	62
	3500K	36°	668	1682	5.9	113	92	52
	4000K	36°	676	1703	5.9	115	93	60
	Crisp White	36°	494	1246	5.9	84	96	67
	Premium White	36°	631	1591	5.9	107	92	50
	Premium Color	36°	587	1478	5.9	99	94	78

1. Luminaire photometry has been conducted in accordance with IES LM-79-08. IES files can be downloaded by clicking the links in the table above, or online at lightolier.com.
2. Crisp White, Premium White and Premium Color - 3000K results.
3. Color Rendering Index (CRI Ra) and Strong Red (R₉) are calculated in accordance with CIE 013.3-1995.

LC OmniSpot LED

Track Heads (600lm, 1000lm & 2000lm)

Aiming Angles Small (600lm)

L and W are the outer points where the candle power drops to 50% of the maximum. FC are the initial footcandles at the center of the beam. Data shown is for 3000K, use the table on the right for CRI/CCT adjustment factors.

D Distance
L Beam length
W Beam Width
A Aiming Angle

C Distance to center beam
FC Footcandles
CBCP Center Beam Candlepower

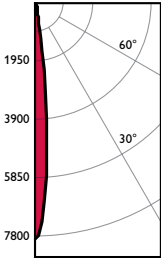
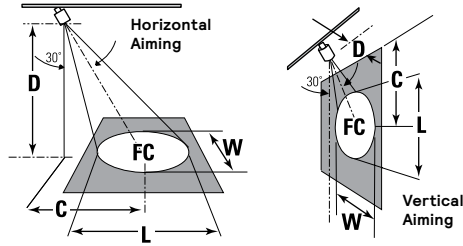

600lm Narrow Spot

LCL06930ALTE + LLMRNS

CCT¹: 3000K
Output lumens: 626 lms
Input watts²: 5.9 W
Efficacy: 106.1 lm/w
CRI: 90 min
CBCP: 7,810 cd

Beam Angle: 12°
Field Angle: 24°

30° Aiming Angle
Horizontal Illuminance on floor

D	C	F.C.	L	W
6	3.5	141	1.7	1.4
8	4.6	79	2.2	1.9
10	5.8	51	2.8	2.4
12	6.9	35	3.3	2.9

30° Aiming Angle
Vertical Illuminance on floor

D	C	F.C.	L	W
2	3.5	244	1.7	0.8
3	5.2	108	2.6	1.2
4	6.9	61	3.4	1.7
5	8.7	39	4.3	2.1

60° Aiming Angle
Horizontal Illuminance on floor

D	C	F.C.	L	W
6	3.5	27	5.2	2.5
8	4.6	15	6.9	3.3
10	5.8	10	8.6	4.2
12	6.9	7	10.3	5.0

60° Aiming Angle
Vertical Illuminance on floor

D	C	F.C.	L	W
2	3.5	1268	0.6	0.5
3	5.2	564	0.8	0.7
4	6.9	317	1.1	1.0
5	8.7	203	1.4	1.2

Certified Test Report No. STMR-76-LLMRNS

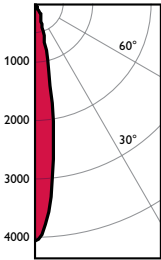

600lm Spot

LCL06930ALTE + LLMRS

CCT¹: 3000K
Output lumens: 625 lms
Input watts²: 5.9 W
Efficacy: 106.0 lm/w
CRI: 90 min
CBCP: 4,023 cd

Beam Angle: 18°
Field Angle: 37°

30° Aiming Angle
Horizontal Illuminance on floor

D	C	F.C.	L	W
6	3.5	73	2.6	2.2
8	4.6	41	3.4	2.9
10	5.8	26	4.3	3.7
12	6.9	18	5.1	4.4

30° Aiming Angle
Vertical Illuminance on floor

D	C	F.C.	L	W
2	3.5	126	2.7	1.3
3	5.2	56	4.1	1.9
4	6.9	31	5.5	2.5
5	8.7	20	6.8	3.2

60° Aiming Angle
Horizontal Illuminance on floor

D	C	F.C.	L	W
6	3.5	14	8.2	3.8
8	4.6	8	11.0	5.1
10	5.8	5	13.7	6.3
12	6.9	3	16.4	7.6

60° Aiming Angle
Vertical Illuminance on floor

D	C	F.C.	L	W
2	3.5	653	0.9	0.7
3	5.2	290	1.3	1.1
4	6.9	163	1.7	1.5
5	8.7	105	2.1	1.8

Certified Test Report No. STMR-76-LLMRNS

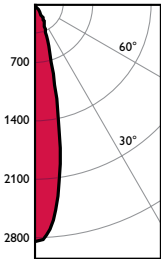

600lm Narrow Flood

LCL06930ALTE + LLMRNF

CCT¹: 3000K
Output lumens: 620 lms
Input watts²: 5.9 W
Efficacy: 105.0 lm/w
CRI: 90 min
CBCP: 2,766 cd

Beam Angle: 23°
Field Angle: 48°

30° Aiming Angle
Horizontal Illuminance on floor

D	C	F.C.	L	W
6	3.5	50	3.3	2.9
8	4.6	28	4.5	3.8
10	5.8	18	5.6	4.8
12	6.9	12	6.7	5.7

30° Aiming Angle
Vertical Illuminance on floor

D	C	F.C.	L	W
2	3.5	86	3.8	1.6
3	5.2	38	5.7	2.5
4	6.9	22	7.6	3.3
5	8.7	14	9.4	4.1

60° Aiming Angle
Horizontal Illuminance on floor

D	C	F.C.	L	W
6	3.5	10	11.3	4.9
8	4.6	5	15.1	6.6
10	5.8	3	18.9	8.2
12	6.9	2	22.7	9.9

60° Aiming Angle
Vertical Illuminance on floor

D	C	F.C.	L	W
2	3.5	449	1.1	1.0
3	5.2	200	1.7	1.4
4	6.9	112	2.2	1.9
5	8.7	72	2.8	2.4

Certified Test Report No. STMR-76-LLMRNF

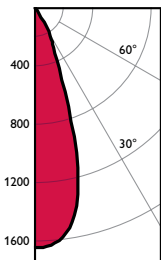

600lm Flood

LCL06930ALTE + LLMRF

CCT¹: 3000K
Output lumens: 617 lms
Input watts²: 5.9 W
Efficacy: 104.6 lm/w
CRI: 90 min
CBCP: 1,555 cd

Beam Angle: 36°
Field Angle: 62°

30° Aiming Angle
Horizontal Illuminance on floor

D	C	F.C.	L	W
6	3.5	28	5.4	4.5
8	4.6	16	7.2	6.0
10	5.8	10	9.0	7.5
12	6.9	7	10.8	9.0

30° Aiming Angle
Vertical Illuminance on floor

D	C	F.C.	L	W
2	3.5	49	7.6	2.6
3	5.2	22	11.4	3.9
4	6.9	12	15.2	5.2
5	8.7	8	19.0	6.5

60° Aiming Angle
Horizontal Illuminance on floor

D	C	F.C.	L	W
6	3.5	5	22.8	7.8
8	4.6	3	30.4	10.4
10	5.8	2	38.0	13.0
12	6.9	1	45.6	15.6

60° Aiming Angle
Vertical Illuminance on floor

D	C	F.C.	L	W
2	3.5	253	1.8	1.5
3	5.2	112	2.7	2.2
4	6.9	63	3.6	3.0
5	8.7	40	4.5	3.7

Certified Test Report No. STMR-76-LLMRF

1. Correlated Color Temperature within specs as defined in ANSI_NEMA_ANSI C78.377-2008: Specifications for the Chromaticity of Solid State Lighting Products.

2. Wattage controlled to within +/- 5%.

Note: Tested using absolute photometry as specified in LM79: IESNA Approved Method for the Electrical and Photometric Measurements of Solid-State Lighting Products.

LC OmniSpot LED

Track Heads (600lm, 1000lm & 2000lm)





Photometry Small (1000lm)

Download
1000lm
IES Files



Download
REVIT files
& BIM files



Beam Spread	Color Temp (CCT)	Beam Angle (FWHM)	Flux (lm)	CBCP	Energy (W)	Efficacy (lm/W)	CRI	R9
Narrow Spot (RNS) 	2700K	12°	1044	12958	11.5	91	93	55
	3000K	12°	1120	13900	11.5	97	93	58
	3500K	12°	1210	15019	11.5	105	91	50
	4000K	12°	1225	15203	11.5	106	92	58
	Crisp White	12°	899	11163	11.5	78	96	67
	Premium White	12°	1146	14222	11.5	100	92	50
	Premium Color	12°	1064	13206	11.5	92	93	78
Spot (RS) 	2700K	18°	1040	6832	11.5	90	93	55
	3000K	18°	1116	7329	11.5	97	93	58
	3500K	18°	1205	7919	11.5	105	91	50
	4000K	18°	1220	8016	11.5	106	92	58
	Crisp White	18°	896	5886	11.5	78	96	67
	Premium White	18°	1141	7499	11.5	99	92	50
	Premium Color	18°	1060	6963	11.5	92	93	78
Narrow Flood (RNF) 	2700K	23°	1016	4572	11.5	88	93	55
	3000K	23°	1090	4905	11.5	95	93	58
	3500K	23°	1177	5299	11.5	102	91	50
	4000K	23°	1192	5364	11.5	104	92	58
	Crisp White	23°	875	3939	11.5	76	96	67
	Premium White	23°	1115	5018	11.5	97	92	50
	Premium Color	23°	1035	4660	11.5	90	93	78
Flood (RF) 	2700K	36°	960	2376	11.5	83	93	55
	3000K	36°	1116	2821	11.5	97	93	58
	3500K	36°	1153	2925	11.5	100	91	50
	4000K	36°	1193	3027	11.5	104	92	58
	Crisp White	36°	896	2265	11.5	78	96	67
	Premium White	36°	1142	2886	11.5	99	92	50
	Premium Color	36°	1051	2663	11.5	89	93	78

1. Luminaire photometry has been conducted in accordance with IES LM-79-08. IES files can be downloaded by clicking the links in the table above, or online at lightolier.com.
2. Crisp White, Premium White and Premium Color - 3000K results.
3. Color Rendering Index (CRI Ra) and Strong Red (R₉) are calculated in accordance with CIE 013.3-1995.

LC OmniSpot LED

Track Heads (600lm, 1000lm & 2000lm)

Aiming Angles Small (1000lm)

L and W are the outer points where the candle power drops to 50% of the maximum. FC are the initial footcandles at the center of the beam. Data shown is for 3000K, use the table on the right for CRI/CCT adjustment factors.

D Distance
L Beam length
W Beam Width
A Aiming Angle
C Distance to center beam
FC Footcandles
CBCP Center Beam Candlepower

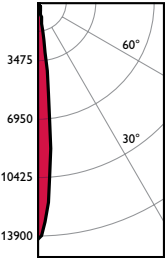
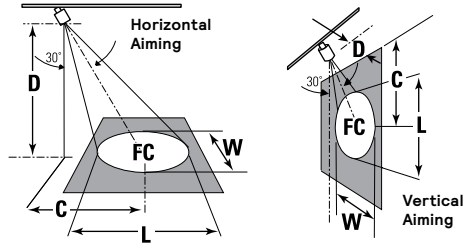

1000lm Narrow Spot

LCL10930ALTE + LLMRS

CCT ¹ :	3000K
Output lumens:	1120 lms
Input watts ² :	11.5 W
Efficacy:	97.4 lm/w
CRI:	90 min
CBCP:	13,900 cd

Beam Angle: 12°
Field Angle: 24°

30° Aiming Angle
Horizontal Illuminance on floor

D	C	F.C.	L	W
6	3.5	251	1.7	1.5
8	4.6	141	2.3	1.9
10	5.8	90	2.8	2.4
12	6.9	63	3.4	2.9

30° Aiming Angle
Vertical Illuminance on floor

D	C	F.C.	L	W
2	3.5	434	1.7	0.8
3	5.2	193	2.6	1.3
4	6.9	109	3.5	1.7
5	8.7	70	4.4	2.1

60° Aiming Angle
Horizontal Illuminance on floor

D	C	F.C.	L	W
6	3.5	48	5.2	2.5
8	4.6	27	7.0	3.4
10	5.8	17	8.7	4.2
12	6.9	12	10.4	5.0

60° Aiming Angle
Vertical Illuminance on floor

D	C	F.C.	L	W
2	3.5	2257	0.6	0.5
3	5.2	1003	0.8	0.7
4	6.9	564	1.1	1.0
5	8.7	361	1.4	1.2

Certified Test Report No. STMR-72-LLMRS

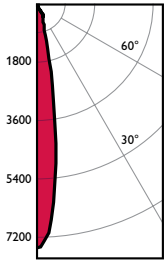

1000lm Spot

LCL10930ALTE + LLMRS

CCT ¹ :	3000K
Output lumens:	1116 lms
Input watts ² :	11.5 W
Efficacy:	97.0 lm/w
CRI:	90 min
CBCP:	7,329 cd

Beam Angle: 18°
Field Angle: 36°

30° Aiming Angle
Horizontal Illuminance on floor

D	C	F.C.	L	W
6	3.5	132	2.5	2.2
8	4.6	74	3.4	2.9
10	5.8	48	4.2	3.6
12	6.9	33	5.1	4.4

30° Aiming Angle
Vertical Illuminance on floor

D	C	F.C.	L	W
2	3.5	229	2.7	1.3
3	5.2	102	4.1	1.9
4	6.9	57	5.4	2.5
5	8.7	37	6.8	3.1

60° Aiming Angle
Horizontal Illuminance on floor

D	C	F.C.	L	W
6	3.5	25	8.1	3.8
8	4.6	14	10.9	5.0
10	5.8	9	13.6	6.3
12	6.9	6	16.3	7.5

60° Aiming Angle
Vertical Illuminance on floor

D	C	F.C.	L	W
2	3.5	1190	0.8	0.7
3	5.2	529	1.3	1.1
4	6.9	298	1.7	1.5
5	8.7	190	2.1	1.8

Certified Test Report No. STMR-72-LLMRS

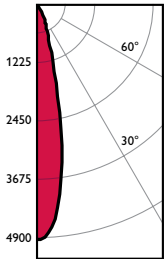

1000lm Narrow Flood

LCL10930ALTE + LLMRF

CCT ¹ :	3000K
Output lumens:	1090 lms
Input watts ² :	11.5 W
Efficacy:	94.8 lm/w
CRI:	90 min
CBCP:	4,905 cd

Beam Angle: 23°
Field Angle: 47°

30° Aiming Angle
Horizontal Illuminance on floor

D	C	F.C.	L	W
6	3.5	88	3.3	2.8
8	4.6	50	4.4	3.8
10	5.8	32	5.6	4.7
12	6.9	22	6.7	5.7

30° Aiming Angle
Vertical Illuminance on floor

D	C	F.C.	L	W
2	3.5	153	3.8	1.6
3	5.2	68	5.6	2.5
4	6.9	38	7.5	3.3
5	8.7	25	9.4	4.1

60° Aiming Angle
Horizontal Illuminance on floor

D	C	F.C.	L	W
6	3.5	17	11.3	4.9
8	4.6	10	15.0	6.6
10	5.8	6	18.8	8.2
12	6.9	4	22.6	9.9

60° Aiming Angle
Vertical Illuminance on floor

D	C	F.C.	L	W
2	3.5	796	1.1	0.9
3	5.2	354	1.7	1.4
4	6.9	199	2.2	1.9
5	8.7	127	2.8	2.4

Certified Test Report No. STMR-72-LLMRF

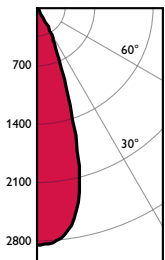

1000lm Flood

LCL10930ALTE + LLMRF

CCT ¹ :	3000K
Output lumens:	1116 lms
Input watts ² :	11.5 W
Efficacy:	97.1 lm/w
CRI:	90 min
CBCP:	2,821 cd

Beam Angle: 36°
Field Angle: 62°

30° Aiming Angle
Horizontal Illuminance on floor

D	C	F.C.	L	W
6	3.5	51	5.4	4.5
8	4.6	29	7.2	6.0
10	5.8	18	9.0	7.5
12	6.9	13	10.8	9.0

30° Aiming Angle
Vertical Illuminance on floor

D	C	F.C.	L	W
2	3.5	88	7.6	2.6
3	5.2	39	11.4	3.9
4	6.9	22	15.2	5.2
5	8.7	14	19.0	6.5

60° Aiming Angle
Horizontal Illuminance on floor

D	C	F.C.	L	W
6	3.5	10	22.8	7.8
8	4.6	6	30.4	10.4
10	5.8	4	38.0	13.0
12	6.9	2	45.6	15.6

60° Aiming Angle
Vertical Illuminance on floor

D	C	F.C.	L	W
2	3.5	458	1.8	1.5
3	5.2	204	2.7	2.2
4	6.9	115	3.6	3.0
5	8.7	73	4.5	3.7

Certified Test Report No. STMR-72-LLMRF

1. Correlated Color Temperature within specs as defined in ANSI_NEMA_ANSI C78.377-2008: Specifications for the Chromaticity of Solid State Lighting Products.

2. Wattage controlled to within +/- 5%.

Note: Tested using absolute photometry as specified in LM79: IESNA Approved Method for the Electrical and Photometric Measurements of Solid-State Lighting Products.

LC OmniSpot LED

Track Heads (600lm, 1000lm & 2000lm)





Photometry Medium (2000lm)

Download
2000lm
IES Files



Download
REVIT files
& BIM files



Beam Spread	Color Temp (CCT)	Beam Angle (FWHM)	Flux (lm)	CBCP	Energy (W)	Efficacy (lm/W)	CRI	R9
Narrow Spot (RNS) 	2700K	11°	1919	33360	23.4	82	93	56
	3000K	11°	2204	35547	23.4	94	92	55
	3500K	11°	2582	38475	23.4	110	93	59
	4000K	11°	2755	39949	23.4	119	93	61
	Crisp White	11°	1521	29531	23.4	65	96	67
	Premium White	11°	2308	36379	23.4	99	92	50
	Premium Color	11°	1934	32383	23.4	82	93	76
Spot (RS) 	2700K	18°	1895	8328	23.4	81	93	56
	3000K	18°	2176	8873	23.4	93	92	55
	3500K	18°	2549	9604	23.4	109	93	59
	4000K	18°	2720	9972	23.4	117	93	61
	Crisp White	18°	1502	7372	23.4	64	96	67
	Premium White	18°	2279	9081	23.4	97	92	50
	Premium Color	18°	1909	8084	23.4	81	93	76
Narrow Flood (RNF) 	2700K	22°	1900	8620	23.4	82	93	56
	3000K	22°	2181	9186	23.4	93	92	55
	3500K	22°	2556	9942	23.4	109	93	59
	4000K	22°	2727	10323	23.4	118	93	61
	Crisp White	22°	1506	7631	23.4	64	96	67
	Premium White	22°	2285	9401	23.4	98	92	50
	Premium Color	22°	1914	8368	23.4	81	93	76
Flood (RF) 	2700K	36°	2004	4753	23.4	86	93	56
	3000K	36°	2143	5064	23.4	92	92	55
	3500K	36°	2319	5481	23.4	99	93	59
	4000K	36°	2445	5691	23.4	105	93	61
	Crisp White	36°	1780	4207	23.4	76	96	67
	Premium White	36°	2193	5183	23.4	94	92	50
	Premium Color	36°	1978	4614	23.4	84	93	76

1. Luminaire photometry has been conducted in accordance with IES LM-79-08. IES files can be downloaded by clicking the links in the table above, or online at lightolier.com.
2. Crisp White, Premium White and Premium Color - 3000K results.
3. Color Rendering Index (CRI Ra) and Strong Red (R₉) are calculated in accordance with CIE 013.3-1995.

LC OmniSpot LED

Track Heads (600lm, 1000lm & 2000lm)

Aiming Angles Medium (2000lm)

L and W are the outer points where the candle power drops to 50% of the maximum. FC are the initial footcandles at the center of the beam. Data shown is for 3000K, use the table on the right for CRI/CCT adjustment factors.

D Distance
L Beam length
W Beam Width
A Aiming Angle
C Distance to center beam
FC Footcandles
CBCP Center Beam Candlepower

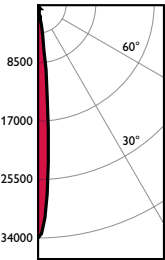
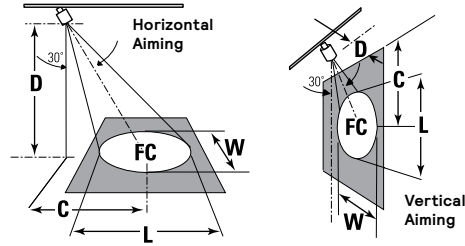

2000lm Narrow Spot

LCL20930ALTE + LLAV11RNS

CCT ¹ :	3000K
Output lumens:	2204 lms
Input watts ² :	23.4 W
Efficacy:	94.3 lm/w
CRI:	90 min
CBCP ³ :	35,547 cd

Beam Angle: 11°
Field Angle: 20°

30° Aiming Angle

Horizontal Illuminance on floor					
D	C	F.C.	L	W	
6	3.5	641	1.5	1.3	
8	4.6	361	2.0	1.7	
10	5.8	231	2.5	2.1	
12	6.9	160	3.0	2.6	

30° Aiming Angle

Vertical Illuminance on floor					
D	C	F.C.	L	W	
2	3.5	1111	1.5	0.7	
3	5.2	494	2.3	1.1	
4	6.9	278	3.0	1.5	
5	8.7	178	3.8	1.9	

60° Aiming Angle

Horizontal Illuminance on floor					
D	C	F.C.	L	W	
6	3.5	123	4.6	2.2	
8	4.6	69	6.1	3.0	
10	5.8	44	7.6	3.7	
12	6.9	31	9.1	4.4	

60° Aiming Angle

Vertical Illuminance on floor					
D	C	F.C.	L	W	
2	3.5	5772	0.5	0.4	
3	5.2	2565	0.7	0.6	
4	6.9	1443	1.0	0.9	
5	8.7	924	1.2	1.1	

Certified Test Report No. SCALED FROM STMR-73-LLAV11RNS

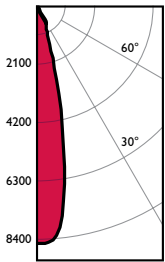

2000lm Spot

LCL20930ALTE + LLAV11RS

CCT ¹ :	3000K
Output lumens:	2213 lms
Input watts ² :	23.4 W
Efficacy:	94.6 lm/w
CRI:	90 min
CBCP ³ :	15,077 cd

Beam Angle: 18°
Field Angle: 34°

30° Aiming Angle

Horizontal Illuminance on floor					
D	C	F.C.	L	W	
6	3.5	272	2.6	2.2	
8	4.6	153	3.4	3.0	
10	5.8	98	4.3	3.7	
12	6.9	68	5.2	4.4	

30° Aiming Angle

Vertical Illuminance on floor					
D	C	F.C.	L	W	
2	3.5	471	2.8	1.3	
3	5.2	209	4.2	1.9	
4	6.9	118	5.5	2.6	
5	8.7	75	6.9	3.2	

60° Aiming Angle

Horizontal Illuminance on floor					
D	C	F.C.	L	W	
6	3.5	52	8.3	3.8	
8	4.6	29	11.1	5.1	
10	5.8	19	13.9	6.4	
12	6.9	13	16.6	7.7	

60° Aiming Angle

Vertical Illuminance on floor					
D	C	F.C.	L	W	
2	3.5	2448	0.9	0.7	
3	5.2	1088	1.3	1.1	
4	6.9	612	1.7	1.5	
5	8.7	392	2.2	1.8	

Certified Test Report No. SCALED FROM 915GFR

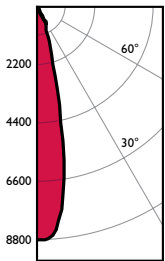

2000lm Narrow Flood

LCL20930ALTE + LLAV11RNF

CCT ¹ :	3000K
Output lumens:	2181 lms
Input watts ² :	23.4 W
Efficacy:	93.4 lm/w
CRI:	90 min
CBCP ³ :	9,186 cd

Beam Angle: 23°
Field Angle: 46°

30° Aiming Angle

Horizontal Illuminance on floor					
D	C	F.C.	L	W	
6	3.5	166	3.2	2.7	
8	4.6	93	4.3	3.7	
10	5.8	60	5.4	4.6	
12	6.9	41	6.4	5.5	

30° Aiming Angle

Vertical Illuminance on floor					
D	C	F.C.	L	W	
2	3.5	287	3.6	1.6	
3	5.2	128	5.4	2.4	
4	6.9	72	7.2	3.2	
5	8.7	46	9.0	4.0	

60° Aiming Angle

Horizontal Illuminance on floor					
D	C	F.C.	L	W	
6	3.5	32	10.8	4.8	
8	4.6	18	14.4	6.3	
10	5.8	11	18.0	7.9	
12	6.9	8	21.5	9.5	

60° Aiming Angle

Vertical Illuminance on floor					
D	C	F.C.	L	W	
2	3.5	1492	1.1	0.9	
3	5.2	663	1.6	1.4	
4	6.9	373	2.1	1.8	
5	8.7	239	2.7	2.3	

Certified Test Report No. SCALED FROM STMR-73-LLAV11RNF

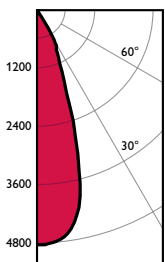

2000lm Flood

LCL20930ALTE + LLAV11RF

CCT ¹ :	3000K
Output lumens:	2143 lms
Input watts ² :	23.4 W
Efficacy:	91.6 lm/w
CRI:	90 min
CBCP ³ :	5,064 cd

Beam Angle: 34°
Field Angle: 62°

30° Aiming Angle

Horizontal Illuminance on floor					
D	C	F.C.	L	W	
6	3.5	91	5.1	4.3	
8	4.6	51	6.8	5.7	
10	5.8	33	8.5	7.1	
12	6.9	23	10.2	8.5	

30° Aiming Angle

Vertical Illuminance on floor					
D	C	F.C.	L	W	
2	3.5	158	6.9	2.5	
3	5.2	70	10.3	3.7	
4	6.9	40	13.7	4.9	
5	8.7	25	17.1	6.1	

60° Aiming Angle

Horizontal Illuminance on floor					
D	C	F.C.	L	W	
6	3.5	18	20.6	7.4	
8	4.6	10	27.4	9.8	
10	5.8	6	34.3	12.3	
12	6.9	4	41.2	14.7	

60° Aiming Angle

Vertical Illuminance on floor					
D	C	F.C.	L	W	
2	3.5	822	1.7	1.4	
3	5.2	365	2.5	2.1	
4	6.9	206	3.4	2.8	
5	8.7	132	4.2	3.5	

Certified Test Report No. STMR-186

1. Correlated Color Temperature within specs as defined in ANSI_NEMA_ANSI C78.377-2008: Specifications for the Chromaticity of Solid State Lighting Products.

2. Wattage controlled to within +/- 5%.

Note: Tested using absolute photometry as specified in LM79: IESNA Approved Method for the Electrical and Photometric Measurements of Solid-State Lighting Products.

