



**Alcyon LED Vertical Recessed Multiples** are ideal for display, accent and task lighting and offer higher efficiency than incandescent or halogen sources leading to energy savings with no ultraviolet or infrared radiation. Alcyon provides concentrated light which dramatically draws interest to objects and elements in a space.

**Now including AccuRender technology for the highest color quality at the highest efficacy.**

Complete unit = Frame + Fixture + Reflector + Optional Accessories

Project: \_\_\_\_\_  
 Location: \_\_\_\_\_  
 Cat.No: \_\_\_\_\_  
 Type: \_\_\_\_\_  
 Qty: \_\_\_\_\_  
 Notes: \_\_\_\_\_

### Frame

example: LLAVRM11H2120

Series	Lumens	Heads	Voltage
<b>LLAVRM</b>			
LLAVRM Alcyon Vertical Recessed Multiples	11 1000,1400lm 20 2000lm	H1 1 head H2 2 head H3 3 head H4 4 head	120 120V 277 277V

### Accessories<sup>1</sup> (order separately)

example: LLA11SNBK

Series	Finishes
<b>Accessory holders<sup>2</sup></b>	
LLAV11AH Alcyon Small	WH Matte White
LLAV12AH Alcyon Medium	BK Matte Black
<b>Snoots</b>	
LLA11SN Alcyon Small	WH Matte White
23SNT6 Alcyon Medium	BK Matte Black
<b>Diffusion films</b>	
LLAV11 Alcyon Small	SF Soft Focus
LLAV12 Alcyon Medium	FR Frosted Etched
	LS Linear Spread
	SY Symmetrical Spread
<b>Hex cell louvers<sup>3</sup></b>	
LLAHCA11 Alcyon Small (matte black only)	
AL4HC Alcyon Medium (matte black only)	

### Fixture with white flanges

example: LLAVRMWH1130H2

Series	Finish	Lumens	CRI/CCT	Heads
<b>LLAVRM</b>				
LLAVRM Alcyon Vertical Recessed Multiples	WH White BK Black	01 1000lm 11 1400lm 20 2000lm	927 90CRI / 2700K 930 90CRI / 3000K 935 90CRI / 3500K 940 90CRI / 4000K	H1 1 head H2 2 head H3 3 head H4 4 head
<b>LED Color Recipes</b> CW30 90CRI / 3000K Crisp White PW30 90CRI / 3000K Premium White PC30 90CRI / 3000K Premium Color				

### Optics

example: LLAV11RNS

Series	Lumens	Beam spreads (ordered separately)
<b>LLAV</b>		
LLAV Alcyon Reflectors	11 Small (for 1000, 1400lm) 12 Medium (for 2000lm)	RNS 10° Narrow Spot RS 18° Spot RNF 24° Narrow Flood RF 36° Flood

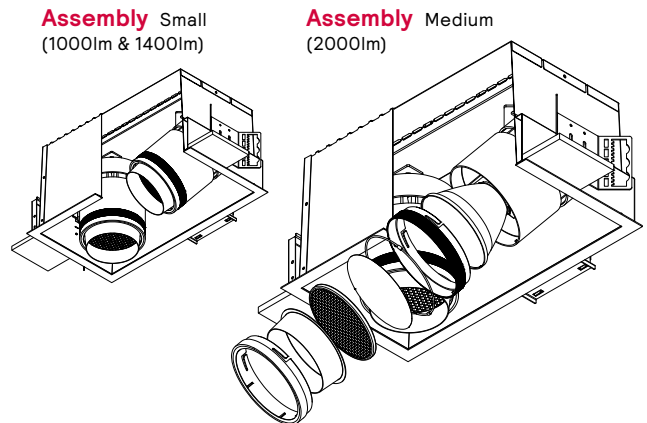

- Aperture ring on the fixture can hold a maximum of 1 film and 1 snoot.
- Accessory holder can hold a maximum of 1 hex cell, 1 film, and 1 snoot.
- Hex cell needs to be ordered with an Accessory holder.

# LLAVRM Alcyon LED Vertical

## Recessed Multiples (1000lm, 1400lm & 2000lm)

### Features

- LED Board:** COB LED.
- Heat Sink:** Die-cast aluminum maintains LED junction temperature for minimum 120,000hr lifetime at 80% lumen maintenance.
- Finishes:** Painted finishes with a baked enamel. Contains some powder coated finishes.
- Heat Sink Arm:** Tool-less aiming with 360° horizontal rotation, 180° vertical tilt and a pull down adjustment from flush recessed to semi-recessed for optimal performance.
- Trim/Housing:** One part integrated system including a seamless flange (16ga powder coated steel), and pre-formed housing (22ga powder coated steel), with pre-wired integral driver(s).
- Frame with mounting brackets:** Mounting brackets are adjustable vertically from inside of Frame-in-kit. Maximum ceiling thickness is 1½". Accepts various types of mounting bars including C-channel, EMT (contractor supplied) and Lightolier mounting bars (Cat. # 1950 or 1951). For use in T-grid or sheet rock ceiling. See page 2 for overall dimensions.
- Junction box:** 4" x 3½" x 2" ; .063" (14ga) galvanized steel.
- Thermal Protector:** Meets NEC and UL requirements. Insulation must be kept 3" away from fixture sides and wiring compartments and must not be placed above fixture in a manner which will entrap heat.
- Luminaire Disconnect:** Power from Frame-in-kit to Trim/Housing connection with quick connect plug.
- Torsion Springs and Safety Springs:** Torsion Springs swivel to allow Trim/Housing to hang temporarily from one end to ease the process of making Luminaire electrical connection complete. Safety Springs allow positive lock between Trim/Housing and Frame-in-kit for added security.
- Interchangeable Optics:** High efficiency metalized coating providing up to 98% total reflectivity for optimal light quality, beam control and punch. Reflector has lens attached which protects reflector finish and LEDs from contamination. Tool-less installation. Reflector sold separately to allow field replacement. Various combinations of beam angles could be achieved with 4 optic offerings.
- Crisp White:** Available in 90CRI / 3000K only, our 90CRI CrispWhite technology combines the warm, saturated colors of high CRI with crisp and vibrant whites. The small form factor and high quality of light make this an impactful option for retail display areas.
- Premium White:** Available in 90CRI/3000K, the new benchmark in retail fashion, delivering stronger, brighter whites via the best technology in the market, but with minimal compromise on energy savings.

- PremiumColor:** Available in 90CRI/3000K only, provides vivid and robust colors that pop while maintaining a strong ambient white and bold black balance in any space. This LED technology is sure to add positive energy to varying application needs.

### Dimming

**10W / 1000lm:** 0-10V dimming compatible.  
**15W / 1400lm:** 0-10V dimming compatible.  
**21W / 2000lm:** 0-10V dimming compatible.

### Electrical (electronic power supply)

**Input voltage:** 120/277V (50/60Hz)  
**Input power:** 10W - 21W  
**Efficacy:** Up to 120lm/W  
**High power factor:** >0.9  
**CRI:** 90+

### Labels

cULus Listed. 5 year warranty.  
 Suitable for damp location  
 ENERGY STAR® certified (excluding Crisp White, Premium White, and Premium Color configurations).  
 Accessories are not Energy Star qualified.



### Accessories

Alcyon LED track lighting offers a full range of high performance accessories for tinting, coloring and shaping of the light beam. All accessories are designed to attach easily. A complete accessory consists of a size and series suffix.

### Components

1. Frame-in kit
2. Trim kit
3. Reflector kit
4. Accessory holder \*
5. Accessory spring \*
6. Diffusion filter
7. Hex cell louver
8. Snoot
9. Aperture ring

\* Accessory holder includes accessory spring (shown to left).

### Hex cell louvers

**LLAHC A11** = 3 1/8" dia.  
**AL4HC** = 4 3/4" dia.



**Hex Cell Louvers:**  
 Reduction in light of 45% (only available in matte black).

### Diffusion films

**LLAV11** = 3 1/8" dia. **LLAV12** = 4 3/4" dia.



**Soft Focus (SF):** Only slightly removes beam's punch while softening edges, slightly widens beam, light reduction of about 10%.

**Frosted Etched (FR):** Increased hiding, smoothing and blending of LED source, takes narrow spot and changes it to about a medium beam distribution, light reduction about 15-20%.

**Linear Spread (LS):** Asymmetrical beam-elongating, creates an elliptical pattern, takes narrow spot and changes it to about 15° x 50° beam angles.

**Symmetrical Spread (SY):** Widens the beam of light in all directions, more pronounced widening effect compared to Solite or frosted, creating larger beam spreads while also softening edges, takes narrow spot and changes it to about 40° beam angle, light reduction of about 20-25%.

### Configurations



# LLAVRM Alcyon LED Vertical

## Recessed Multiples (1000lm, 1400lm & 2000lm)



### AccuRender Technology (CRI 90+)

The right light brings colors to life. Our new AccuRender technology helps ensure colors are rendered more accurately and consistently, while doing so as efficiently as CRI 80 products.



**Standard CRI 80**  
Good color rendering and high efficacy



**Standard CRI 90**  
Better color rendering and low efficacy



**AccuRender**  
Best color rendering, color preference and high efficacy

#### Enjoy design flexibility

Full range of products and options:

- Available soon in across Lightolier portfolio for application flexibility
- Multiple color temperatures (CCTs) and lumen packages offered

#### Promote savings

High efficacy, with no penalty:

- Energy efficacy compares well to conventional 80 CRI
- Up to 25% more energy savings vs competitor 90 CRI<sup>1</sup>
- Helps meet Title 24 requirements

#### Show your true colors

High color rendering:

- True to life colors to help energize your environment and render better flesh tones critical for healthcare hospitality and retail applications.
- R<sub>a</sub> up to 94 CRI
- R<sub>g</sub> up to 67 CRI
- G<sub>a</sub> up to 99 CRI
- C<sub>9</sub> up to 94 CRI
- R<sub>f</sub> up to 92 TM-30
- R<sub>r,hi</sub> up to 91 TM-30
- R<sub>g</sub> up to 100 TM-30
- R<sub>cb,hi</sub> up to -5% TM-30

#### Achieve color balance

Best in class color consistency:

- Promote aesthetic harmony in your space with  $\leq 2$  SDCM

#### LED Color Recipes

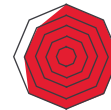
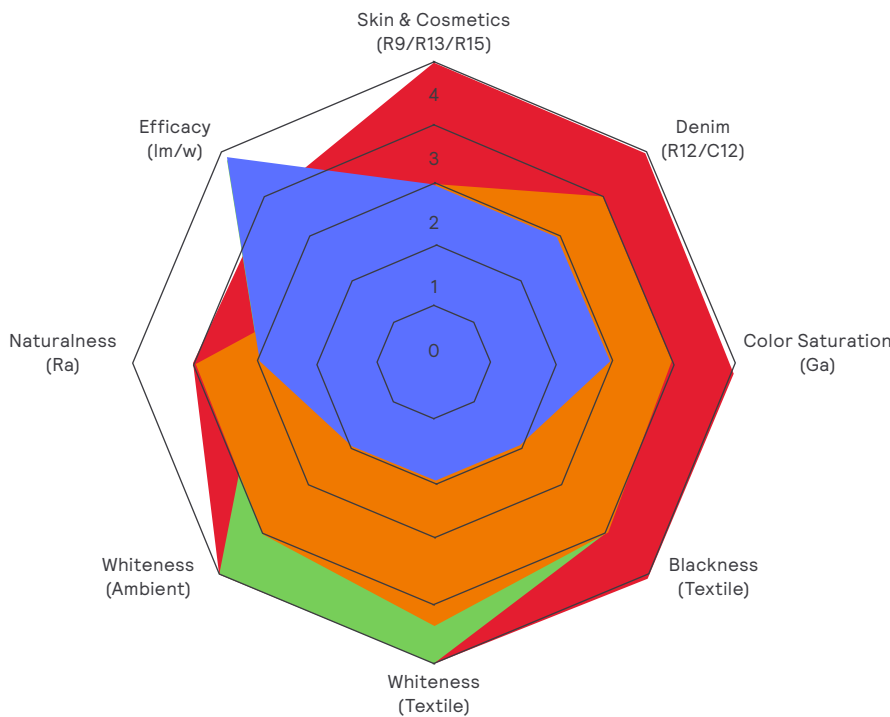

#### Crisp White

Dial-up the drama of your display. Highlight the variances in white tones, add contrast to blacks and create a real pleasing sparkle effect while retaining warm skin tones.

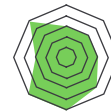

#### Premium White

The new benchmark for retail fashion. Delivering stronger and brighter whites via the best lighting technology on the market with minimal compromise to energy savings.



#### Premium Color

Enhance the contrast between colors and whites to achieve new depths of color rendering for a vibrant saturated fashion-forward visual experience that won't affect the atmosphere and will have a positive effect on energy efficiency.

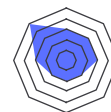

#### Standard Color

Standard CRI 90

# LLAVRM Alcyon LED Vertical

## Recessed Multiples (1000lm, 1400lm & 2000lm)

### Dimensions Small (1000lm & 1400lm)

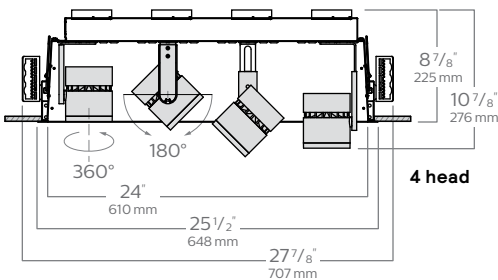
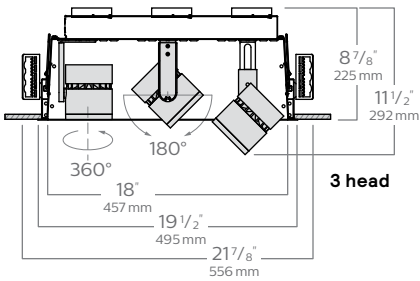
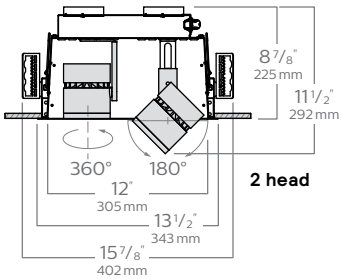
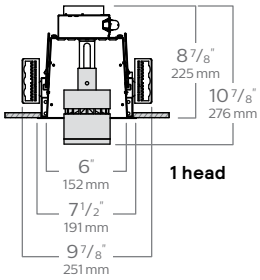
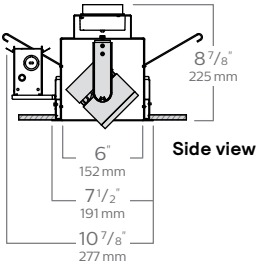

### Dimensions Medium (2000lm)

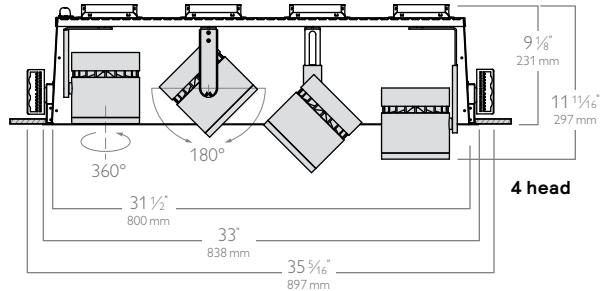
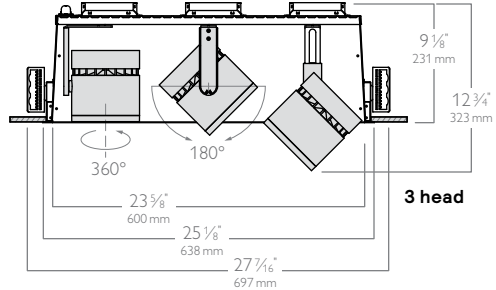
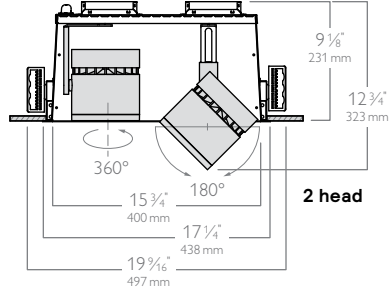
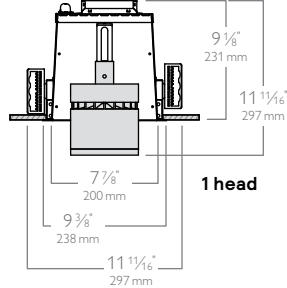
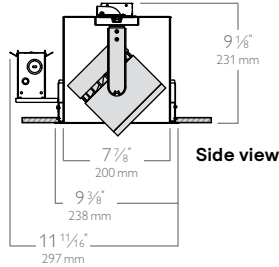

# LLAVRM Alcyon LED Vertical

## Recessed Multiples (1000lm, 1400lm & 2000lm)





### Photometry Small (1000lm)

Download  
1000lm  
IES Files



Download  
REVIT files  
& BIM files



Beam Spread	Color Temp (CCT)	Beam Angle (FWHM)	Flux (lm)	CBCP	Energy (W)	Efficacy (lm/W)	CRI	R9
<b>Narrow Spot (RNS)</b> 	2700K	11°	949	13459	10	95	93	57
	3000K	11°	991	14060	10	99	93	58
	3500K	11°	1040	14751	10	104	93	59
	4000K	11°	1061	15051	10	106	93	60
	Crisp White	11°	746	10580	10	75	96	67
	Premium White	11°	1006	14262	10	101	92	50
	Premium Color	11°	917	13004	10	92	93	78
<b>Spot (RS)</b> 	2700K	18°	938	6189	10	94	93	57
	3000K	18°	980	6465	10	98	93	58
	3500K	18°	1028	6783	10	103	93	59
	4000K	18°	1049	6921	10	105	93	60
	Crisp White	18°	737	4865	10	74	96	67
	Premium White	18°	994	6558	10	99	92	50
	Premium Color	18°	906	5979	10	91	93	78
<b>Narrow Flood (RNF)</b> 	2700K	24°	930	3757	10	93	93	57
	3000K	24°	972	3925	10	97	93	58
	3500K	24°	1019	4118	10	102	93	59
	4000K	24°	1040	4202	10	104	93	60
	Crisp White	24°	731	2954	10	73	96	67
	Premium White	24°	986	3981	10	99	92	50
	Premium Color	24°	899	3630	10	90	93	78
<b>Flood (RF)</b> 	2700K	36°	922	2130	10	92	93	57
	3000K	36°	963	2225	10	96	93	58
	3500K	36°	1011	2334	10	101	93	59
	4000K	36°	1031	2382	10	103	93	60
	Crisp White	36°	725	1674	10	72	96	67
	Premium White	36°	977	2257	10	98	92	50
	Premium Color	36°	891	2058	10	89	93	78

1. Luminaire photometry has been conducted in accordance with IES LM-79-08. IES files can be downloaded by clicking the links in the table above, or online at [lightolier.com](http://lightolier.com).
2. Crisp White, Premium White and Premium Color - 3000K results.
3. Color Rendering Index (CRI Ra ) and Strong Red (R<sub>9</sub>) are calculated in accordance with CIE 013.3-1995.

# LLAVRM Alcyon LED Vertical

## Recessed Multiples (1000lm, 1400lm & 2000lm)

### Aiming Angles Small (1000lm)

L and W are the outer points where the candle power drops to 50% of the maximum. FC are the initial footcandles at the center of the beam. Data shown is for 3000K, use the table on the right for CRI/CCT adjustment factors.

D Distance  
L Beam length  
W Beam Width  
A Aiming Angle

C Distance to center beam  
FC Footcandles  
CBCP Center Beam Candlepower

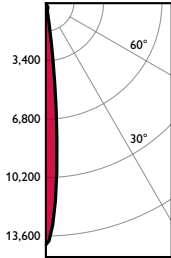
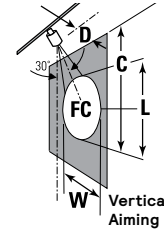
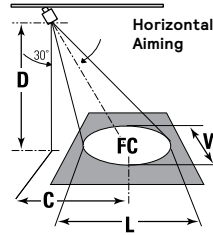

### 1000lm Narrow Spot

**LLAVRM01930 + LLAV11RNS**

CCT <sup>1</sup> :	3000K
Output lumens:	991 lms
Input watts <sup>2</sup> :	10.0 W
Efficacy:	99.1 lm/w
CRI:	90 min
CBCP:	14,060 cd

Beam Angle: 10.9°  
Field Angle: 20.4°

#### 30° Aiming Angle Horizontal Illuminance on floor

D	C	F.C.	L	W
6	3.5	254	1.5	1.3
8	4.6	143	2.0	1.8
10	5.8	91	2.6	2.2
12	6.9	63	3.1	2.6

#### 30° Aiming Angle Vertical Illuminance on floor

D	C	F.C.	L	W
2	3.5	439	1.6	0.8
3	5.2	195	2.4	1.1
4	6.9	110	3.1	1.5
5	8.7	70	3.9	1.9

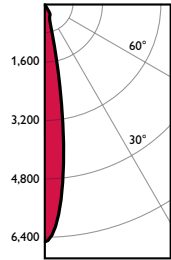

### 1000lm Spot

**LLAVRM01930 + LLAV11RS**

CCT <sup>1</sup> :	3000K
Output lumens:	980 lms
Input watts <sup>2</sup> :	10.0 W
Efficacy:	98.0 lm/w
CRI:	90 min
CBCP:	6,465 cd

Beam Angle: 18.1°  
Field Angle: 33.4°

#### 30° Aiming Angle Horizontal Illuminance on floor

D	C	F.C.	L	W
6	3.5	117	2.6	2.2
8	4.6	66	3.4	2.9
10	5.8	42	4.3	3.7
12	6.9	29	5.1	4.4

#### 30° Aiming Angle Vertical Illuminance on floor

D	C	F.C.	L	W
2	3.5	202	2.8	1.3
3	5.2	90	4.1	1.9
4	6.9	51	5.5	2.5
5	8.7	32	6.9	3.2

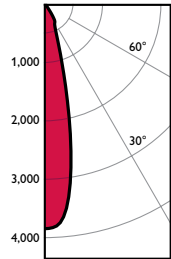

### 1000lm Narrow Flood

**LLAVRM01930 + LLAV11RF**

CCT <sup>1</sup> :	3000K
Output lumens:	972 lms
Input watts <sup>2</sup> :	10.0 W
Efficacy:	97.2 lm/w
CRI:	90 min
CBCP:	3,925 cd

Beam Angle: 24.3°  
Field Angle: 50.6°

#### 30° Aiming Angle Horizontal Illuminance on floor

D	C	F.C.	L	W
6	3.5	71	3.5	3.0
8	4.6	40	4.7	4.0
10	5.8	25	5.8	5.0
12	6.9	18	7.0	6.0

#### 30° Aiming Angle Vertical Illuminance on floor

D	C	F.C.	L	W
2	3.5	123	4.0	1.7
3	5.2	55	6.0	2.6
4	6.9	31	8.0	3.4
5	8.7	20	10.0	4.3

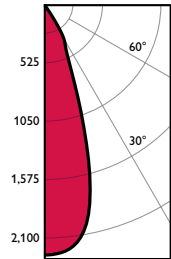

### 1000lm Flood

**LLAVRM01930 + LLAV11RF**

CCT <sup>1</sup> :	3000K
Output lumens:	963 lms
Input watts <sup>2</sup> :	10.0 W
Efficacy:	96.3 lm/w
CRI:	90 min
CBCP:	2,225 cd

Beam Angle: 36.4°  
Field Angle: 65.7°

#### 30° Aiming Angle Horizontal Illuminance on floor

D	C	F.C.	L	W
6	3.5	40	5.5	4.6
8	4.6	23	7.3	6.1
10	5.8	14	9.1	7.6
12	6.9	10	10.9	9.1

#### 30° Aiming Angle Vertical Illuminance on floor

D	C	F.C.	L	W
2	3.5	70	7.8	2.6
3	5.2	31	11.7	3.9
4	6.9	17	15.6	5.3
5	8.7	11	19.5	6.6

1. Correlated Color Temperature within specs as defined in ANSI\_NEMA\_ANSI C78.377-2008: Specifications for the Chromaticity of Solid State Lighting Products.

2. Wattage controlled to within +/- 5%.

Note: Tested using absolute photometry as specified in LM79: IESNA Approved Method for the Electrical and Photometric Measurements of Solid-State Lighting Products.

# LLAVRM Alcyon LED Vertical

## Recessed Multiples (1000lm, 1400lm & 2000lm)





### Photometry Small (1400lm)

Download  
1400lm  
IES Files



Download  
REVIT files  
& BIM files



Beam Spread	Color Temp (CCT)	Beam Angle (FWHM)	Flux (lm)	CBCP	Energy (W)	Efficacy (lm/W)	CRI	R9
<b>Narrow Spot (RNS)</b> 	2700K	11°	1347	19452	14	94	93	56
	3000K	11°	1407	20322	14	98	93	55
	3500K	11°	1477	21327	14	103	93	59
	4000K	11°	1507	21761	14	105	93	60
	Crisp White	11°	1066	15399	14	74	96	67
	Premium White	11°	1428	20617	14	99	92	50
	Premium Color	11°	1301	18794	14	90	93	77
<b>Spot (RS)</b> 	2700K	18°	1334	8739	14	93	93	56
	3000K	18°	1394	9130	14	97	93	55
	3500K	18°	1463	9581	14	102	93	59
	4000K	18°	1492	9776	14	104	93	60
	Crisp White	18°	1056	6918	14	73	96	67
	Premium White	18°	1414	9263	14	98	92	50
	Premium Color	18°	1289	8444	14	90	93	77
<b>Narrow Flood (RNF)</b> 	2700K	24°	1321	5326	14	92	93	56
	3000K	24°	1380	5565	14	96	93	55
	3500K	24°	1449	5840	14	101	93	59
	4000K	24°	1478	5959	14	103	93	60
	Crisp White	24°	1046	4217	14	73	96	67
	Premium White	24°	1400	5646	14	97	92	50
	Premium Color	24°	1277	5146	14	89	93	77
<b>Flood (RF)</b> 	2700K	36°	1315	3034	14	91	93	56
	3000K	36°	1374	3170	14	95	93	55
	3500K	36°	1442	3327	14	100	93	59
	4000K	36°	1471	3394	14	102	93	60
	Crisp White	36°	1041	2402	14	72	96	67
	Premium White	36°	1394	3216	14	97	92	50
	Premium Color	36°	1270	2932	14	88	93	77

1. Luminaire photometry has been conducted in accordance with IES LM-79-08. IES files can be downloaded by clicking the links in the table above, or online at [lightolier.com](http://lightolier.com).
2. Crisp White, Premium White and Premium Color - 3000K results.
3. Color Rendering Index (CRI Ra) and Strong Red (R<sub>9</sub>) are calculated in accordance with CIE 013.3-1995.

# LLAVRM Alcyon LED Vertical

## Recessed Multiples (1000lm, 1400lm & 2000lm)

### Aiming Angles Small (1400lm)

L and W are the outer points where the candle power drops to 50% of the maximum. FC are the initial footcandles at the center of the beam. Data shown is for 3000K, use the table on the right for CRI/CCT adjustment factors.

D Distance  
L Beam length  
W Beam Width  
A Aiming Angle

C Distance to center beam  
FC Footcandles  
CBCP Center Beam Candlepower

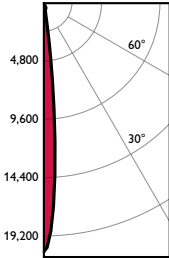
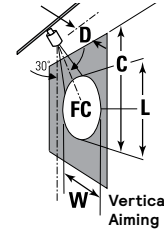
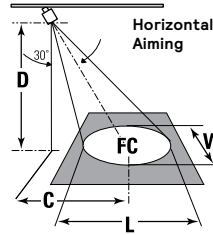

### 1400lm Narrow Spot

LLAVRM11930 + LLAV11RNS

CCT<sup>1</sup>: 3000K  
Output lumens: 1407 lms  
Input watts<sup>2</sup>: 14.4 W  
Efficacy: 97.7 lm/w  
CRI: 90 min  
CBCP: 20,322 cd

Beam Angle: 10.7°  
Field Angle: 20.4°

30° Aiming Angle  
Horizontal Illuminance on floor

D	C	F.C.	L	W
6	3.5	367	1.5	1.3
8	4.6	206	2.0	1.7
10	5.8	132	2.5	2.2
12	6.9	92	3.0	2.6

30° Aiming Angle  
Vertical Illuminance on floor

D	C	F.C.	L	W
2	3.5	635	1.5	0.8
3	5.2	282	2.3	1.1
4	6.9	159	3.1	1.5
5	8.7	102	3.9	1.9

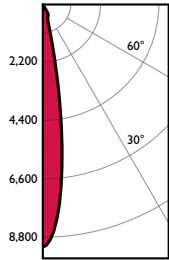

### 1400lm Spot

LLAVRM11930 + LLAV11RS

CCT<sup>1</sup>: 3000K  
Output lumens: 1394 lms  
Input watts<sup>2</sup>: 14.4 W  
Efficacy: 96.8 lm/w  
CRI: 90 min  
CBCP: 9,130cd

Beam Angle: 18.1°  
Field Angle: 33.4°

30° Aiming Angle  
Horizontal Illuminance on floor

D	C	F.C.	L	W
6	3.5	165	2.6	2.2
8	4.6	93	3.4	2.9
10	5.8	59	4.3	3.7
12	6.9	41	5.2	4.4

30° Aiming Angle  
Vertical Illuminance on floor

D	C	F.C.	L	W
2	3.5	285	2.8	1.3
3	5.2	127	4.1	1.9
4	6.9	71	5.5	2.6
5	8.7	46	6.9	3.2

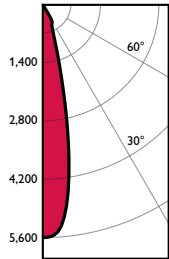

### 1400lm Narrow Flood

LLAVRM11930 + LLAV11RNF

CCT<sup>1</sup>: 3000K  
Output lumens: 1380 lms  
Input watts<sup>2</sup>: 14.4 W  
Efficacy: 95.9 lm/w  
CRI: 90 min  
CBCP: 5,565 cd

Beam Angle: 24.3°  
Field Angle: 50.6°

30° Aiming Angle  
Horizontal Illuminance on floor

D	C	F.C.	L	W
6	3.5	100	3.5	3.0
8	4.6	56	4.7	4.0
10	5.8	36	5.8	5.0
12	6.9	25	7.0	6.0

30° Aiming Angle  
Vertical Illuminance on floor

D	C	F.C.	L	W
2	3.5	174	4.0	1.7
3	5.2	77	6.0	2.6
4	6.9	43	8.0	3.4
5	8.7	28	10.0	4.3

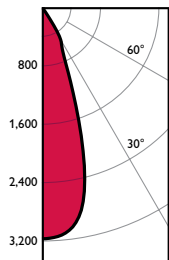

### 1400lm Flood

LLAVRM11930 + LLAV11RF

CCT<sup>1</sup>: 3000K  
Output lumens: 1374 lms  
Input watts<sup>2</sup>: 14.4 W  
Efficacy: 95.4 lm/w  
CRI: 90 min  
CBCP: 3,170 cd

Beam Angle: 36.4°  
Field Angle: 65.7°

30° Aiming Angle  
Horizontal Illuminance on floor

D	C	F.C.	L	W
6	3.5	57	5.5	4.6
8	4.6	32	7.3	6.1
10	5.8	21	9.1	7.6
12	6.9	14	10.9	9.1

30° Aiming Angle  
Vertical Illuminance on floor

D	C	F.C.	L	W
2	3.5	99	7.8	2.6
3	5.2	44	11.7	3.9
4	6.9	25	15.6	5.3
5	8.7	16	19.4	6.6

1. Correlated Color Temperature within specs as defined in ANSI\_NEMA\_ANSI C78.377-2008: Specifications for the Chromaticity of Solid State Lighting Products.

2. Wattage controlled to within +/- 5%.

Note: Tested using absolute photometry as specified in LM79: IESNA Approved Method for the Electrical and Photometric Measurements of Solid-State Lighting Products.



# LLAVRM Alcyon LED Vertical

## Recessed Multiples (1000lm, 1400lm & 2000lm)





### Photometry Medium (2000lm)

Download  
2000lm  
IES Files



Download  
REVIT files  
& BIM files



Beam Spread	Color Temp (CCT)	Beam Angle (FWHM)	Flux (lm)	CBCP	Energy (W)	Efficacy (lm/W)	CRI	R9
<b>Narrow Spot (RNS)</b> 	2700K	11°	2214	31271	21	107	93	55
	3000K	11°	2313	32676	21	112	92	58
	3500K	11°	2428	34308	21	117	93	59
	4000K	11°	2478	35007	21	120	93	61
	Crisp White	11°	1771	25019	21	86	96	67
	Premium White	11°	2347	33158	21	113	92	50
	Premium Color	11°	2139	30216	21	103	93	76
<b>Spot (RS)</b> 	2700K	20°	2216	11445	21	107	93	55
	3000K	20°	2316	11959	21	112	92	58
	3500K	20°	2431	12557	21	117	93	59
	4000K	20°	2481	12812	21	120	93	61
	Crisp White	20°	1773	9157	21	86	96	67
	Premium White	20°	2350	12136	21	114	92	50
	Premium Color	20°	2141	11059	21	103	93	76
<b>Narrow Flood (RNF)</b> 	2700K	24°	2199	8763	21	106	93	55
	3000K	24°	2297	9156	21	111	92	58
	3500K	24°	2412	9613	21	117	93	59
	4000K	24°	2461	9809	21	119	93	61
	Crisp White	24°	1759	7011	21	85	96	67
	Premium White	24°	2331	9291	21	113	92	50
	Premium Color	24°	2124	8467	21	103	93	76
<b>Flood (RF)</b> 	2700K	36°	2243	5171	21	108	93	55
	3000K	36°	2344	5403	21	113	92	58
	3500K	36°	2461	5673	21	119	93	59
	4000K	36°	2511	5789	21	121	93	61
	Crisp White	36°	1794	4137	21	87	96	67
	Premium White	36°	2378	5483	21	115	92	50
	Premium Color	36°	2167	4997	21	105	93	76

1. Luminaire photometry has been conducted in accordance with IES LM-79-08. IES files can be downloaded by clicking the links in the table above, or online at [lightolier.com](http://lightolier.com).

2. Crisp White, Premium White and Premium Color - 3000K results.

3. Color Rendering Index (CRI Ra) and Strong Red (R<sub>s</sub>) are calculated in accordance with CIE 013.3-1995.

# LLAVRM Alcyon LED Vertical

## Recessed Multiples (1000lm, 1400lm & 2000lm)

### Aiming Angles Medium (2000lm)

L and W are the outer points where the candle power drops to 50% of the maximum. FC are the initial footcandles at the center of the beam. Data shown is for 3000K, use the table on the right for CRI/CCT adjustment factors.

D Distance  
L Beam length  
W Beam Width  
A Aiming Angle  
C Distance to center beam  
FC Footcandles  
CBCP Center Beam Candlepower

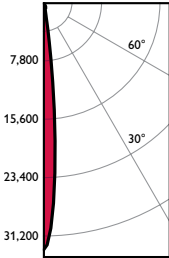
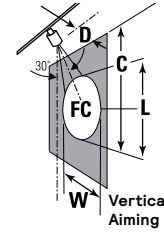
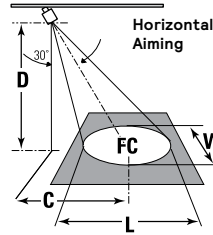

### 2000lm Narrow Spot

LLAVRM20930 + LLAV12RNS

CCT<sup>1</sup>: 3000K  
Output lumens: 2313 lms  
Input watts<sup>2</sup>: 20.7 W  
Efficacy: 111.7 lm/w  
CRI: 90 min  
CBCP: 32,676 cd

Beam Angle: 10.9°  
Field Angle: 20.6°

30° Aiming Angle  
Horizontal Illuminance on floor

D	C	F.C.	L	W
6	3.5	590	1.5	1.3
8	4.6	332	2.0	1.8
10	5.8	212	2.5	2.2
12	6.9	147	3.1	2.6

30° Aiming Angle  
Vertical Illuminance on floor

D	C	F.C.	L	W
2	3.5	1021	1.6	0.8
3	5.2	454	2.3	1.1
4	6.9	255	3.1	1.5
5	8.7	163	3.9	1.9

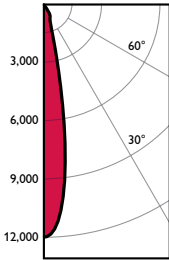

### 2000lm Spot

LLAVRM20930 + LLAV12RS

CCT<sup>1</sup>: 3000K  
Output lumens: 2316 lms  
Input watts<sup>2</sup>: 20.7 W  
Efficacy: 111.9 lm/w  
CRI: 90 min  
CBCP: 11,959cd

Beam Angle: 20.4°  
Field Angle: 39.7°

30° Aiming Angle  
Horizontal Illuminance on floor

D	C	F.C.	L	W
6	3.5	216	2.9	2.5
8	4.6	121	3.9	3.3
10	5.8	78	4.8	4.2
12	6.9	54	5.8	5.0

30° Aiming Angle  
Vertical Illuminance on floor

D	C	F.C.	L	W
2	3.5	374	3.2	1.4
3	5.2	166	4.8	2.2
4	6.9	93	6.4	2.9
5	8.7	60	8.0	3.6

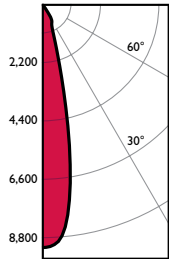

### 2000lm Narrow Flood

LLAVRM20930 + LLAV12RNF

CCT<sup>1</sup>: 3000K  
Output lumens: 2297 lms  
Input watts<sup>2</sup>: 20.7 W  
Efficacy: 111.0 lm/w  
CRI: 90 min  
CBCP: 9,156 cd

Beam Angle: 24.1°  
Field Angle: 48.1°

30° Aiming Angle  
Horizontal Illuminance on floor

D	C	F.C.	L	W
6	3.5	165	3.5	3.0
8	4.6	93	4.6	4.0
10	5.8	59	5.8	4.9
12	6.9	41	6.9	5.9

30° Aiming Angle  
Vertical Illuminance on floor

D	C	F.C.	L	W
2	3.5	286	4.0	1.7
3	5.2	127	5.9	2.6
4	6.9	72	7.9	3.4
5	8.7	46	9.9	4.3

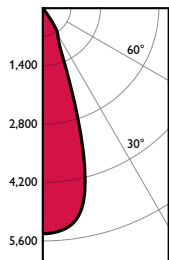

### 2000lm Flood

LLAVRM20930 + LLAV12RF

CCT<sup>1</sup>: 3000K  
Output lumens: 2344 lms  
Input watts<sup>2</sup>: 20.7 W  
Efficacy: 113.2 lm/w  
CRI: 90 min  
CBCP: 5,403 cd

Beam Angle: 36.2°  
Field Angle: 67.6°

30° Aiming Angle  
Horizontal Illuminance on floor

D	C	F.C.	L	W
6	3.5	97	5.4	4.5
8	4.6	55	7.2	6.0
10	5.8	35	9.0	7.5
12	6.9	24	10.8	9.1

30° Aiming Angle  
Vertical Illuminance on floor

D	C	F.C.	L	W
2	3.5	169	7.7	2.6
3	5.2	75	11.5	3.9
4	6.9	42	15.4	5.2
5	8.7	27	19.2	6.5

1. Correlated Color Temperature within specs as defined in ANSI\_NEMA\_ANSI C78.377-2008: Specifications for the Chromaticity of Solid State Lighting Products.

2. Wattage controlled to within +/- 5%.

Note: Tested using absolute photometry as specified in LM79: IESNA Approved Method for the Electrical and Photometric Measurements of Solid-State Lighting Products.

