



Ledalite ModiFly suspended is the new action hero for lighting design. This next generation lighting innovation has it all: contemporary form, infinite design freedom, and undisputed performance. Simple, yet sophisticated, ModiFly has a style that lends itself perfectly for a variety of spaces including open offices, education, and retail environments, where visual comfort and design continuity are essential.

ModiFly now includes AccuRender technology for the highest color quality at the highest efficacy.

Project: _____
 Location: _____
 Cat.No: _____
 Type: _____
 Qty: _____
 Notes: _____

Ordering guide

example: MFOSL93545QN08DE1NNNW, M1-24

Family	Version ^{7,8}	Type	Source	CRI/CCT ¹
MF		S	L	
MF ModiFly	O Straight Run with Static Links B Straight Run with Bi-Links Pre-defined Patterns: TRIA Triangle Pattern CRSS Cross Pattern SQRE Square Pattern HEXA Hexagon Pattern OCTA Octagon Pattern WHYY Y-Shape Pattern CSTM Custom Patterns	S Suspended	L LED	950 CRI 90, 5000K 930 CRI 90, 3000K 940 CRI 90, 4000K 927 CRI 90, 2700K 935 CRI 90, 3500K 8T2 CRI 80, 2700-6500K 2ch Tunable White (confirm controls) ⁵
Lumens ¹	Optics	Distribution	Run Length	
45 4500 lm/4ft 25 2500 lm/4ft 40 4000 lm/4ft 20 2000 lm/4ft 35 3500 lm/4ft 15 1500 lm/4ft 30 3000 lm/4ft	Q	N	02 2ft 06 6ft 04 4ft 08 8ft 05 5ft XX Continuous run in 1ft increments (please specify)	
Voltage	Driver	Circuit ^{2,11}	Wiring Option ²	System/Controls ¹⁰
D UNV 120-277V 3 347V ³	E Advance Xitanium 0-10V (1% Dim)	1 Single Circuit	N None B Battery Pack ³ E Aux. Wiring ⁶	NN None
D UNV 120-277V	D Advance Xitanium DALI (5% Dim) ³ H Lutron EcoSystem LDE1 (<1% Dim, Fade-to-Black) ³			
D UNV 120-277V	S Advance Xitanium Sensor Ready (1% Dim) ³	1 Single Circuit	N None B Battery Pack ³	NN None CS Interact Pro scalable wireless sensor with integral daylight & occupancy sensing, advanced grouping with dwell time ^{4,12} SB Interact Pro wireless sensor with occupancy, daylight, and environmental sensing capabilities ^{4,11,12}
L Low Voltage (48-54V DC)	P PoE Lighting Controller	1 Single Circuit	N None B Battery Pack ³	NN None IO Interact Office wired sensor with integral daylighting & occupancy sensing, enables wired connected lighting control ^{4,13} SB Interact Office advanced wired sensor with occupancy, daylight, and environmental sensing capabilities ^{4,11,12}
Finish	Mount Type ⁹	Suspension		
W Standard White T Titanium Silver H Hero Gold B Black S Silver Nova C Custom V Venom Black	M1 Non-accessible ceiling, 0'-15' Slope Mount M2 T-Grid Fixed Position Mount M3 Non-accessible ceiling, 0'-90' Slope Mount M5 T-Grid 24" Span Mount (non tegular tile only)	M6-1 T-Grid On-Grid Mount 15/16" (non tegular tile only) M6-2 T-Grid On-Grid Mount 9/16" (non tegular tile only) M6-3 T-Grid On-Grid Mount 9/16" x 5/16" (slot tee & tegular tile)		
		24 24" 144 144" 48 48" 192 192" 96 96" 240 240"		

ModiFly suspended

Options

Standalone

Keep it simple with standalone modiles, available in 5 standard lengths (consult Ledalite for custom lengths).

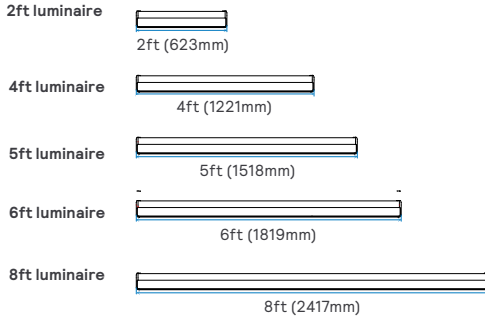

Continuous Run

Continuous Run in 1ft increments.

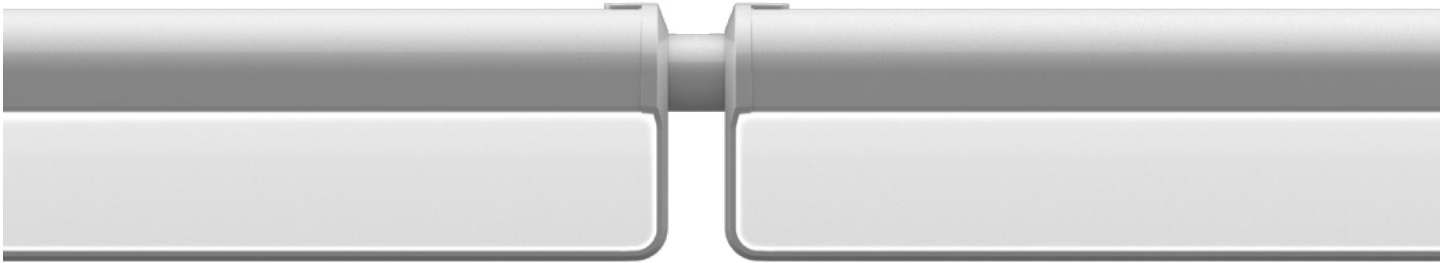
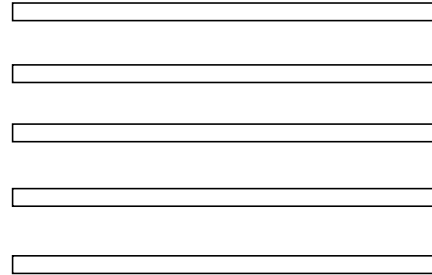

With a variety of different length options, continuous rows of ModiFly can be used to fill an open office for comfortable, ambient illumination. The image above shows ModiFly with a static link between modules for continuous rows of luminaires.

Finish options



White (W)



Titanium Silver (T)



Black (B)



Hero Gold (H)



Silver Nova (S)



Venom Black (V)



Custom (C)

ModiFly suspended

Predefined patterns

Shake things up, and modify spaces with ModiFly luminaires to create an endless array of patterns - whether it be pods of pendants or interconnected hexagons in space - ModiFly allows for ultimate flexibility, making lighting the key element of architectural design.

The patterns below are just some of the examples ModiFly has to offer. Choose from one of these, or customize your own pattern.



Triangle
Order Code: TRIA



Square
Order Code: SQRE



Hexagon
Order Code: HEXA

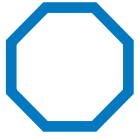

Octagon
Order Code: OCTA



Y-shape
Order Code: WHY3



Cross
Order Code: CRSS

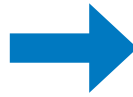

Example Pattern Configuration Details



Example order code:
MF-CRSS-SL94045QN05DE1NNNW, M1-24

Cross

Order Code: CRSS

System includes:

- (4) ModiFly Luminaires (of equal length)
- (1) ModiFly Quad-Link
- (5) Aircraft Cables
- (2) Power Cords
- (2) Power Mount Canopies
- (3) Non-power Mount Canopies
- (4) Endcaps

Configure custom patterns

Can't find the right pre-defined shape for your project? Just sketch out your vision, and we'll bring it to life. For a quote, please contact your Signify inside sales representative.

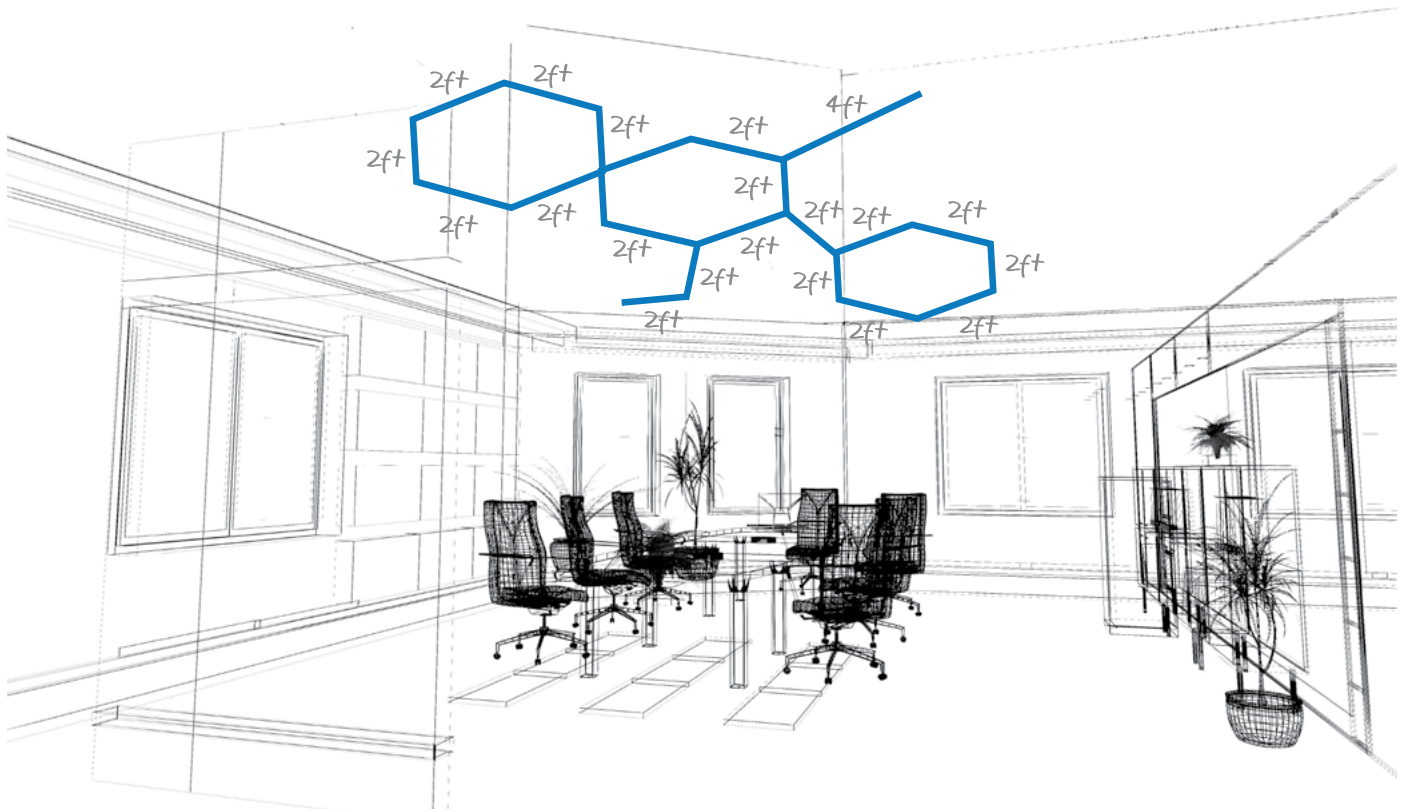

ModiFly suspended

Dimensions

Suspended

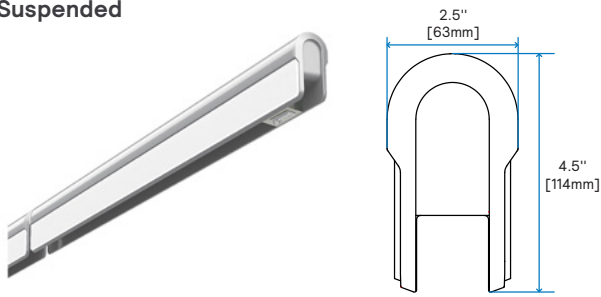

ModiFly articulating links

Harness the ultimate flexibility of on-site articulation of luminaires. Create one-of-a-kind designs with unique shapes and precision angles ModiFly's patent pending design of the factory pre-wired Bi, Tri, and Quad-link systems allow for articulating luminaires on-site, allowing for final touches of angulation to be just perfect.

Static Link*

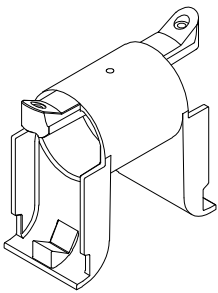

Bi-Link

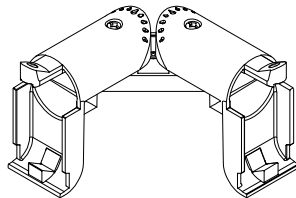

Tri-Link

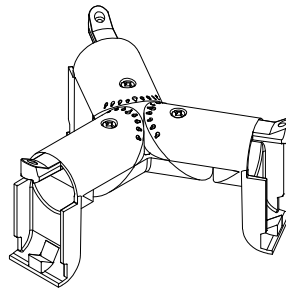

Quad-Link

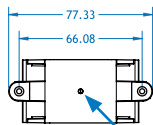
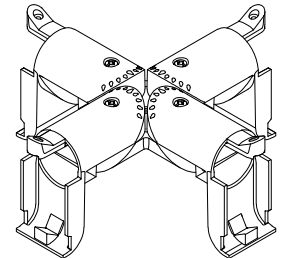

Aircraft cable mount point

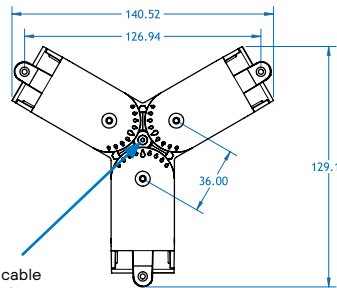
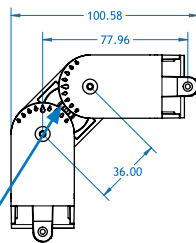

Aircraft cable mount point

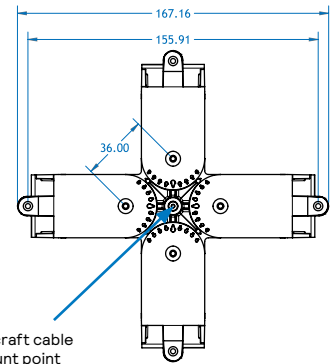

Aircraft cable mount point

*Static links apply to continuous runs only; all other links apply to patterns/shapes.

On-site luminaire rotation

With fool-proof angulation, rotation of pendant modules to achieve the look desired becomes flawless.

Simply match up the markings on the arms of the link to rotate fixture modules 7.5 degree increments (with markings at 15 degrees).

15 degree increment markings to make onsite articulation, easy!

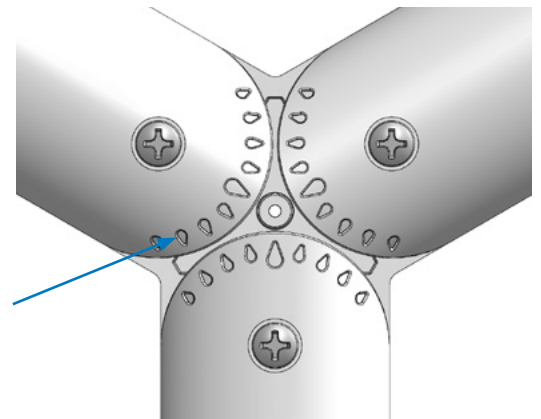

ModiFly suspended

Specifications

Optical System

The optical system contains arrays of LEDs edge lighting a low profile light guide panel, using total internal reflection to homogenize the sources. The microstructure surface of the light guide optimizes light extraction to create an efficacious direct distribution. Standard distribution is 72% down/28% up.

Construction

Housing: Extruded architectural finish aluminum.

Endcaps: Die-cast aluminum.

Luminaire Weight: Max weight 3.75lbs/ft, or 15lbs/4ft.

Finish

Standard powder coat finish options: Hero Gold, Venom Black, Silver Nova, White, Black, Titanium Silver

Electrical

Fixtures are factory pre-wired to section ends with quick-wire connectors and tested for all circuits and backup battery packs. LED boards and drivers are easily field replaceable with access from below the ceiling. Power drops can be specified in white or clear cord options.

Standard Drivers

Advance Xitanium 0-10V, 1% Dimming

Advance Xitanium SR, 1% Dimming (Interact Pro or Interact Office Wireless)

Advance Xitanium DALI, 5% Dimming

Lutron EcoSystem LDE1, 1% Dimming with Soft-on, Fade-to-Black

PoE Lighting Controller (by Signify)

Class 2 rated output. Consult Ledalite for other available drivers.

Power Factor: >0.90

Total Harmonic Distortion: <20%

Standard Battery Packs

Bodine, 90 min, 10W, Class 2 rated output.

Battery Pack lumen output = 10W x luminaire efficacy x 1.1.

Typical output: 1300lm

Lumen Maintenance

LEDs have been tested by the manufacturer in accordance with IESNA LM-80-15. At an ambient temperature of 25°C, the LED lumen maintenance expectation according to IES TM-21-11 is: L80 (10K) > 60,000 hours (reported methodology).

Source Color

LEDs rated for color rendering of:

CRI $R_a \geq 90$, $R_g \geq 50$, $G_a \geq 97$, $C_g \geq 90$

IES TM-30-18 : $R_f \geq 90$, $R_{f,hl} \geq 89$, $R_g \geq 99$, $R_{cs,hl} \geq -5\%$

SPD and TM-30-18 reports available upon request

Fixture to fixture color accuracy within:

2 SDCM for Static White luminaires

3 SDCM for Tunable White luminaires

Mounting

Standard mounting kits (M1 to M6) are available for drywall, t-grid, and non-accessible ceiling types (see [Ledalite Mounting document for details](#)).

Power and non-power canopies standard finish is white. M1 and M3 canopies can be finished to match fixture color.

Approvals

Luminaires are certified for safety to UL1589 and CSAC22.2. No.250.0

Complies in accordance with CAN ICES-005-A/NEB-005-A and FCC Part 15A.

Select ModiFly configurations contribute toward satisfying features L03, L04, L06, L07 and L08 under the WELL v2 Building Standard®

Environment

Rated for dry or damp locations in operating ambient temperatures 0-25°C (32-77°F).

Many luminaire components, such as reflectors, refractors, lenses, and LEDs are made from various types of plastics which can be adversely affected by airborne contaminants. If sulfur-based chemicals, petroleum-based products, cleaning solutions, or other contaminants are expected in the intended area of use, consult factory for compatibility. Damage caused by sulfur, chlorine, petroleum-based solution or other contaminants are not covered under warranty. Not suitable for natatorium environments.

Warranty

Five-year luminaire limited warranty including LED boards and drivers.

www.signify.com/warranties

QuickShip

10-day QuickShip available for most configurations upon request. More information available at:

www.signify.com/en-us/brands/ledalite/quickship

ModiFly suspended

Wireless Controls Options

Interact Pro scalable sensor for Foundation, Advanced & Enterprise tiers (CS is an evolution of SpaceWise):

- CS is a connected sensor with integral occupancy and daylight sensing and supports wireless mesh connectivity.
- The sensor works in the Foundation mode (similar to SpaceWise) when configured without a gateway or in an Interact Pro Advanced or Enterprise mode if a compatible gateway is used.
- Interact Pro includes an App, a portal and a broad portfolio of wireless luminaires, lamps and retrofit kits all working on the same system.
- Startup is implemented via Interact Pro App (Android or iPhone) & Bluetooth connectivity. The App provides flexibility to choose between a gateway or non gateway mode for setup.
- Setup with the gateway requires wired internet access to the gateway. It is possible to add a gateway at a later point.
- Prepare project configuration steps remotely and use IRT9015 remote onsite to identify and group devices together.
- Compatible with UID8451/10 wireless dimmer switch, SWS200 wireless scene switch, wireless Occ sensor (OCC SENSOR IA CM IP42 WH 10/1) and wireless Day/Occ sensor (OCC MULTI SENSOR IA CM WH 10/1).
- For more information on Interact Pro visit: www.interact-lighting.com/interactproscalablesystem

Emergency Options (R):

- Power Sensing (Factory default) – Recommended
- UL924 option requires unswitched power sense line, absence of voltage on the normal circuit triggers luminaire to 100% output.
- Power Interruption Detection (Field option)
- Detects AC power interruption >30ms triggers 90 minute emergency mode with luminaire at 100% output.

Interact Pro scalable sensor bundles for Enterprise tier (SB):

- SB option, in addition to occupancy and daylight sensing, supports advanced IoT capabilities such as people estimation analysis, desk level temperature & humidity sensing, noise classification, and BLE beacon.
- Compatible with UID8451/10 wireless dimmer switch, SWS200 wireless scene switch, wireless Occ sensor (OCC SENSOR IA CM IP42 WH 10/1) and wireless Day/Occ sensor (OCC MULTI SENSOR IA CM WH 10/1).
- Use Interact software and insights to increase building efficiency, achieve building wide integration and optimize space through occupancy analytics.
- Requires compatible Gateway and internet connectivity for commissioning. For more information, visit: www.interact-lighting.com/office

Wired Controls Options

Interact Office Wired PoE (IO & SB):

- PoE based IoT connected lighting solution for large enterprises that span across multiple floors, buildings and require multiple gateways.
- Use Interact software and insights to increase building efficiency, achieve building wide integration and optimize space through occupancy analytics.
- Integral sensor option for occupancy sensing (PIR) and/or daylight harvesting available for additional energy savings.
- SB option, in addition to occupancy and daylight sensing, supports advanced IoT capabilities such as people estimation analysis, desk level temperature & humidity sensing, noise classification, and BLE beacon.
- Optional integral emergency controller and battery pack provides backup lighting in the case of a power outage. Test switch and indicator light mounted on the chassis.
- Emergency battery has a 3 month pre-installed shelf life, and must be stored and installed in environments of -20°C to 30°C (-4F to 86F) ambient, and 45-85% relative humidity.
- For more information on Interact Office Wired visit: www.interact-lighting.com/office

Note: Signify Interact Office Luminaires are not sold individually and are only compatible with Signify's Interact Office control system & software. The system requires a compatible back-end IT infrastructure for normal operations, please consult your Signify representative for additional information.

Tunable White:

- Tunable White is available in Interact Office Wired PoE luminaires. Other control options for Tunable White with DALI (DT6 or DT8), 0-10V, Lutron T Series or DMX control are available via an Engineered-to-Order (ETO) request.
- Signify tunable white solutions are designed to help maximize the influence of lighting on your daily life.
- Dynamic behaviors via scheduled lighting recipes mimicking daylight patterns or supporting biorhythms.
- Scene setting via lighting pre-sets based on various combinations of lighting color temperature and intensity.

Interact Pro scalable sensor option codes across Genlyte product lines

	Evokit	Day-Brite	Ledalite	Lightolier
ZeeBee + Bluetooth + Sensing	SWZCS	SWZCS	CS	SBA accessory (external)
ZeeBee + Bluetooth	RADIO	RADIO	RA	RA
ZeeBee + Bluetooth + Sensing + Environmental data	IAOSB	IAOSB	SB	SB
ZeeBee + Highbay + Sensing	-	SWZCSH	-	-

ModiFly suspended

Interact Pro scalable system			
	Foundation	Advanced	Enterprise
Dimming, grouping, and zoning	✓	✓	✓
Bluetooth and ZigBee enabled	✓	✓	✓
Motion sensing and daylight harvesting	✓	✓	✓
Integration with 0-10V and phase dimming fixtures	✓	✓	✓
Code compliance	✓	✓	✓
Granular dimming and dwell time	✓	✓	✓
Energy reporting and monitoring		✓	✓
Scheduling		✓	✓
Demand response		✓	✓
BMS integration (BACnet)			✓
Floor plan visualization			✓
IoT sensors for wellness			✓
IoT Apps for productivity			✓

Currently supported maximum system size

To be able to design the lighting system correctly for the customer, it is important to know the prime characteristics of the system, its possibilities and limitations.

System level	
Total number of gateways	Unlimited
Total number of devices	200 per network
• luminaires with integrated sensors	150
• smart TLEDS	150
Total number of ZGP devices (sensors and switches)	50
• sensors	30
• switches	50
• zones and groups	64
Group level	
Recommended number of lights	40 (recommended 25)
Number of ZGP devices	5
Number of scenes	16

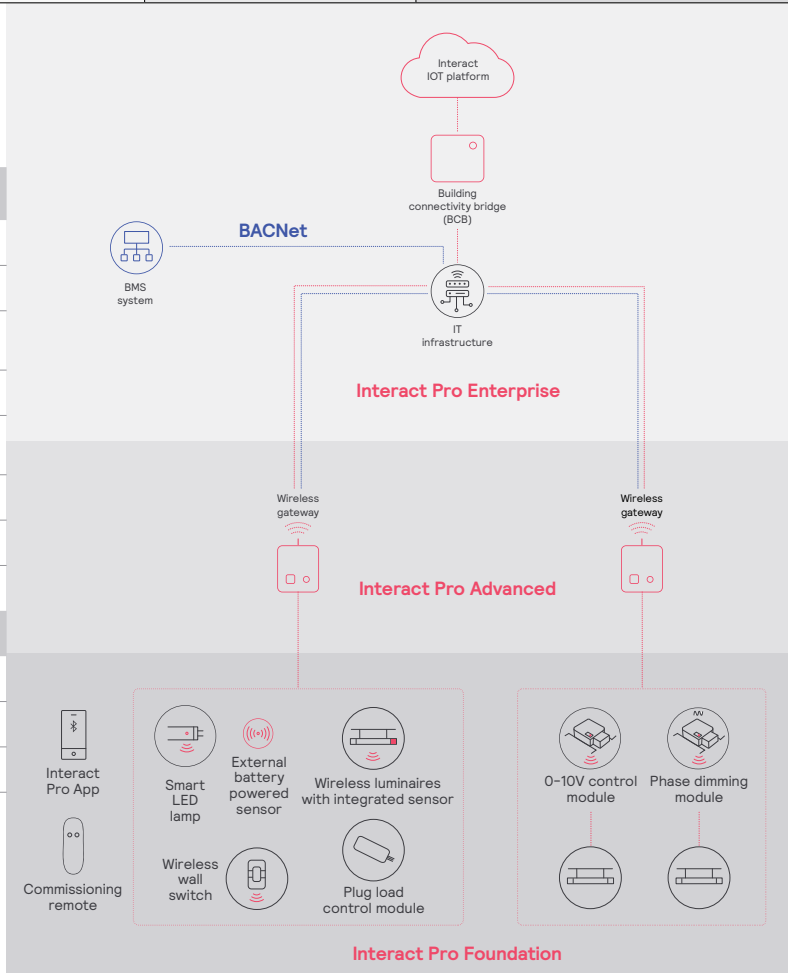

ModiFly suspended

Colorimetry

ModiFly suspended (MFxS) AccuRender Static White

Nominal CRI & CCT		CRI 90, 2700K	CRI 90, 3000K	CRI 90, 3500K	CRI 90, 4000K	CRI 90, 5000K
CIE 013.3-1995 ¹	CRI R_a	94	94	94	93	93
	R_9	56	58	61	64	67
	G_a	99	99	99	98	97
	C_9	93	93	93	94	94
IES TM-30-18 ²	R_f	92	92	91	91	90
	R_{f,h_1}	90	91	90	91	89
	R_g	99	100	100	99	99
	R_{cs,h_1}	-5%	-5%	-5%	-5%	-5%
MDER ³		0.44	0.50	0.57	0.64	0.79

1. Color Rendering Index (CRI Ra) and Strong Red (R9) are calculated in accordance with CIE 013.3-1995. Color Gamut index (Ga) and red chroma Index (C9) are CIE based properties using the Global Lighting Association's calculation tool.

2. Fidelity Index (Rf), Red Fidelity Index (Rf,h1), Gamut Index (Rg), and Red Local Chroma Shift (Rcs,h1) are calculated in accordance with IES TM-30-18.

3. Melanopic Daylight Efficacy Ratio (MDER) is the measure for "spectral melanopic efficiency" as defined in CIE S 026-2018.

ModiFly suspended

Photometry

ModiFly (MFx) – 4ft suspended

Click "PDF" or "IES" text to download

Nominal CRI & CCT		CRI 90, 2700K					CRI 90, 3000K					CRI 90, 3500K					CRI 90, 4000K					CRI 90, 5000K				
Nominal Lumen Package (lm/4ft)	Watts	Flux (lm/4ft) ¹	Efficacy (LPW) ¹	UGR ²	Photometry Report	IES File	Flux (lm/4ft) ¹	Efficacy (LPW) ¹	UGR ²	Photometry Report	IES File	Flux (lm/4ft) ¹	Efficacy (LPW) ¹	UGR ²	Photometry Report	IES File	Flux (lm/4ft) ¹	Efficacy (LPW) ¹	UGR ²	Photometry Report	IES File	Flux (lm/4ft) ¹	Efficacy (LPW) ¹	UGR ²	Photometry Report	IES File
4500	34.3	3,980	116.0	22.9	PDF	IES	4,071	118.7	23.0	PDF	IES	4,204	122.6	23.1	PDF	IES	4,277	124.7	23.1	PDF	IES	4,438	129.4	23.3	PDF	IES
4000	31.4	3,517	112.0	22.5	PDF	IES	3,597	114.6	22.5	PDF	IES	3,695	117.7	22.6	PDF	IES	3,759	119.7	22.7	PDF	IES	3,900	124.2	22.8	PDF	IES
3500	27.4	3,093	112.9	22.0	PDF	IES	3,173	115.8	22.1	PDF	IES	3,192	116.5	22.1	PDF	IES	3,353	122.4	22.3	PDF	IES	3,440	125.5	22.4	PDF	IES
3000	23.5	2,623	111.6	21.4	PDF	IES	2,691	114.5	21.5	PDF	IES	2,714	115.5	21.6	PDF	IES	2,850	121.3	21.7	PDF	IES	2,925	124.5	21.8	PDF	IES
2500	19.3	2,238	116.0	20.9	PDF	IES	2,325	120.5	21.0	PDF	IES	2,346	121.6	21.1	PDF	IES	2,416	125.2	21.2	PDF	IES	2,484	128.7	21.3	PDF	IES
2000	15.7	1,800	114.6	20.1	PDF	IES	1,870	119.1	20.3	PDF	IES	1,887	120.2	20.3	PDF	IES	1,941	123.6	20.4	PDF	IES	1,996	127.1	20.5	PDF	IES
1500	12.2	1,322	108.4	19.1	PDF	IES	1,373	112.5	19.2	PDF	IES	1,385	113.5	19.2	PDF	IES	1,440	118.0	19.4	PDF	IES	1,480	121.3	19.5	PDF	IES

ModiFly (MFx) – 2ft suspended

Click "PDF" or "IES" text to download

Nominal CRI & CCT		CRI 90, 2700K					CRI 90, 3000K					CRI 90, 3500K					CRI 90, 4000K					CRI 90, 5000K				
Nominal Lumen Package (lm/4ft)	Watts	Flux (lm/4ft) ¹	Efficacy (LPW) ¹	UGR ²	Photometry Report	IES File	Flux (lm/4ft) ¹	Efficacy (LPW) ¹	UGR ²	Photometry Report	IES File	Flux (lm/4ft) ¹	Efficacy (LPW) ¹	UGR ²	Photometry Report	IES File	Flux (lm/4ft) ¹	Efficacy (LPW) ¹	UGR ²	Photometry Report	IES File	Flux (lm/4ft) ¹	Efficacy (LPW) ¹	UGR ²	Photometry Report	IES File
4500	18.0	1,990	110.6	22.6	PDF	IES	2,036	113.1	22.7	PDF	IES	2,102	116.8	22.8	PDF	IES	2,139	118.8	22.8	PDF	IES	2,219	123.3	23.0	PDF	IES
4000	16.3	1,759	107.9	22.2	PDF	IES	1,799	110.4	22.2	PDF	IES	1,847	113.3	22.3	PDF	IES	1,879	115.3	22.4	PDF	IES	1,950	119.6	22.5	PDF	IES
3500	14.5	1,546	106.6	21.7	PDF	IES	1,587	109.4	21.8	PDF	IES	1,596	110.1	21.8	PDF	IES	1,676	115.6	22.0	PDF	IES	1,720	118.6	22.1	PDF	IES
3000	12.5	1,311	104.9	21.1	PDF	IES	1,345	107.6	21.2	PDF	IES	1,357	108.6	21.3	PDF	IES	1,425	114.0	21.4	PDF	IES	1,462	117.0	21.5	PDF	IES
2500	10.9	1,136	104.2	20.6	PDF	IES	1,162	106.6	20.7	PDF	IES	1,173	107.6	20.8	PDF	IES	1,208	110.8	20.9	PDF	IES	1,242	113.9	21.0	PDF	IES
2000	9.3	900	96.8	19.8	PDF	IES	935	100.5	20.0	PDF	IES	943	101.4	20.0	PDF	IES	971	104.4	20.1	PDF	IES	998	107.3	20.2	PDF	IES
1500	7.6	661	87.0	18.8	PDF	IES	686	90.3	18.9	PDF	IES	693	91.2	18.9	PDF	IES	720	94.7	19.1	PDF	IES	740	97.4	19.2	PDF	IES

- 4ft Luminaire photometry has been conducted in accordance with IES LM-79-08. IES files can be downloaded by clicking the links in the table above, or online at ledalite.com. Luminaires with finishes other than standard white may result in a drop in flux and efficacy.
- Unified Glare Ratio (UGR) is calculated in accordance with CIE 117-1995. Reference conditions of 4Hx8Hx1H and reflectances of 70/50/20% have been applied using the procedure described in CIE 190-2010.

Vertical Light Guide Symmetric Throw Spacing Criteria: 1.12/1.84

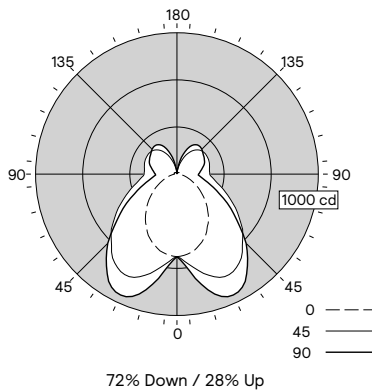

Candela plot shown is for 4000lm/4ft, CRI 90, 3500K configuration.

ModiFly suspended with PoE

Photometry

ModiFly (MFx) – 4ft suspended with PoE

Click "PDF" or "IES" text to download

Nominal CRI & CCT		CRI 90, 2700K					CRI 90, 3000K					CRI 90, 3500K					CRI 90, 4000K					CRI 90, 5000K				
Nominal Lumen Package (lm/4ft)	Watts	Flux (lm/4ft) ¹	Efficacy (LPW) ¹	UGR ²	Photometry Report	IES File	Flux (lm/4ft) ¹	Efficacy (LPW) ¹	UGR ²	Photometry Report	IES File	Flux (lm/4ft) ¹	Efficacy (LPW) ¹	UGR ²	Photometry Report	IES File	Flux (lm/4ft) ¹	Efficacy (LPW) ¹	UGR ²	Photometry Report	IES File	Flux (lm/4ft) ¹	Efficacy (LPW) ¹	UGR ²	Photometry Report	IES File
4500	32.3	3,980	123.2	22.9	PDF	IES	4,071	126.0	23.0	PDF	IES	4,204	130.2	23.1	PDF	IES	4,277	132.4	23.1	PDF	IES	4,438	137.4	23.3	PDF	IES
4000	28.7	3,517	122.5	22.5	PDF	IES	3,597	125.3	22.5	PDF	IES	3,695	128.7	22.6	PDF	IES	3,759	131.0	22.7	PDF	IES	3,900	135.9	22.8	PDF	IES
3500	25.0	3,093	123.7	22.0	PDF	IES	3,173	126.9	22.1	PDF	IES	3,192	127.7	22.1	PDF	IES	3,353	134.1	22.3	PDF	IES	3,440	137.6	22.4	PDF	IES
3000	20.9	2,623	125.5	21.4	PDF	IES	2,691	128.8	21.5	PDF	IES	2,714	129.9	21.6	PDF	IES	2,850	136.4	21.7	PDF	IES	2,925	140.0	21.8	PDF	IES
2500	17.7	2,238	126.4	20.9	PDF	IES	2,325	131.4	21.0	PDF	IES	2,346	132.5	21.1	PDF	IES	2,416	136.5	21.2	PDF	IES	2,484	140.3	21.3	PDF	IES
2000	14.3	1,800	125.9	20.1	PDF	IES	1,870	130.8	20.3	PDF	IES	1,887	132.0	20.3	PDF	IES	1,941	135.7	20.4	PDF	IES	1,996	139.6	20.5	PDF	IES
1500	11.0	1,322	120.2	19.1	PDF	IES	1,373	124.8	19.2	PDF	IES	1,385	125.9	19.2	PDF	IES	1,440	130.9	19.4	PDF	IES	1,480	134.5	19.5	PDF	IES

ModiFly (MFx) – 2ft suspended with PoE

Click "PDF" or "IES" text to download

Nominal CRI & CCT		CRI 90, 2700K					CRI 90, 3000K					CRI 90, 3500K					CRI 90, 4000K					CRI 90, 5000K				
Nominal Lumen Package (lm/4ft)	Watts	Flux (lm/4ft) ¹	Efficacy (LPW) ¹	UGR ²	Photometry Report	IES File	Flux (lm/4ft) ¹	Efficacy (LPW) ¹	UGR ²	Photometry Report	IES File	Flux (lm/4ft) ¹	Efficacy (LPW) ¹	UGR ²	Photometry Report	IES File	Flux (lm/4ft) ¹	Efficacy (LPW) ¹	UGR ²	Photometry Report	IES File	Flux (lm/4ft) ¹	Efficacy (LPW) ¹	UGR ²	Photometry Report	IES File
4500	16.0	1,990	124.4	22.6	PDF	IES	2,036	127.3	22.7	PDF	IES	2,102	131.4	22.8	PDF	IES	2,139	133.7	22.8	PDF	IES	2,219	138.7	23.0	PDF	IES
4000	14.3	1,759	123	22.2	PDF	IES	1,799	125.8	22.2	PDF	IES	1,847	129.2	22.3	PDF	IES	1,879	131.4	22.4	PDF	IES	1,950	136.4	22.5	PDF	IES
3500	12.7	1,546	121.7	21.7	PDF	IES	1,587	125	21.8	PDF	IES	1,596	125.7	21.8	PDF	IES	1,676	132	22.0	PDF	IES	1,720	135.4	22.1	PDF	IES
3000	11.0	1,311	119.2	21.1	PDF	IES	1,345	122.3	21.2	PDF	IES	1,357	123.4	21.3	PDF	IES	1,425	129.5	21.4	PDF	IES	1,462	132.9	21.5	PDF	IES
2500	9.5	1,136	119.6	20.6	PDF	IES	1,162	122.3	20.7	PDF	IES	1,173	123.5	20.8	PDF	IES	1,208	127.2	20.9	PDF	IES	1,242	130.7	21.0	PDF	IES
2000	7.7	900	116.9	19.8	PDF	IES	935	121.4	20.0	PDF	IES	943	122.5	20.0	PDF	IES	971	126.1	20.1	PDF	IES	998	129.6	20.2	PDF	IES
1500	5.9	661	112	18.8	PDF	IES	686	116.3	18.9	PDF	IES	693	117.5	18.9	PDF	IES	720	122	19.1	PDF	IES	740	125.4	19.2	PDF	IES

1. 4ft Luminaire photometry has been conducted in accordance with IES LM-79-08. IES files can be downloaded by clicking the links in the table above, or online at ledalite.com. Luminaires with finishes other than standard white may result in a drop in flux and efficacy.
2. Unified Glare Ratio (UGR) is calculated in accordance with CIE 117-1995. Reference conditions of 4Hx8Hx1H and reflectances of 70/50/20% have been applied using the procedure described in CIE 190-2010.

Vertical Light Guide

Symmetric throw

Spacing Criteria: 1.12/1.84

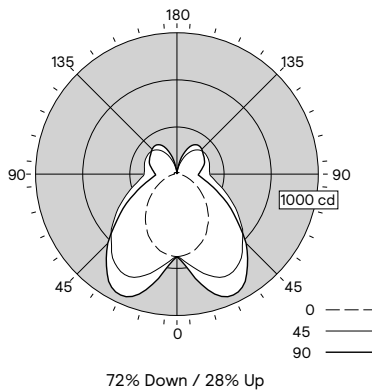

Candela plot shown is for 4000lm/4ft, CRI 90, 3500K configuration.

ModiFly suspended

Footnotes from page 1 ordering guide

1. Nominal values within a range. Not all lumen packages are available with all configurations. Consult photometry data for CRI, color temp, lumens & distribution of chosen configuration.
2. Not all wiring types are available with all configurations. Consult Ledalite for a complete list of available options.
3. 347V not available with Battery Pack, GTD, DALI, Lutron EcoSystem or Sensor Ready drivers or Interact Pro options. Battery packs available in modules > 4ft (lumen package limits may apply, check with Ledalite)
4. Interact Pro & Interact Office Wired (PoE) options require separate controls hardware by Signify.
5. Tunable White is available in Interact Office Wired PoE luminaires. Please enquire about options for Tunable White with DALI (DT6 or DT8), 0-10V, Lutron T Series or DMX control (extended lead times may apply).
6. Auxiliary Wiring not available with Interact Pro or Interact Office Wired (PoE) luminaires. Aux sections are wired to one fixture end only.
7. Version code for specification purposes only, product will ship as "MF0S". Bi-links can be articulated 180 degrees on site to create unique open patterns using linear modules.
8. See spec sheet for specifying patterns.
9. T-Grid On-Grid mounts (M6-x) are not available with Quad-Link joints due to weight restrictions.
10. Sensors are only available in white, but can be combined with any luminaire finish.
11. Luminaires are pre-wired to both ends with quick wire connectors at one end for standard circuit & battery pack trigger wire (if applicable). Each circuit has its own neutral conductor. All circuits are clearly labelled at each end.
12. Must order IRT9015 Interact commissioning remote with each system order.
13. This option is available on request. Other options not shown here may also be possible via a custom request. Extended lead times and minimum order quantities may apply, please consult factory.

Note: Due to continuing product improvements, Ledalite reserves the right to change the specifications without notice.

