



Lumec Ancestra LED pendant luminaires present a new twist on a classic design. By combining the best aspects of past and present forms with the best that modern technology has to offer, the **Ancestra** luminaires epitomizes Lumec's design philosophy beautifully: to combine the best technology with elegant design.

Project: _____
 Location: _____
 Cat.No: _____
 Type: _____
 Qty: _____
 Notes: _____

Ordering guide

example: AT50-C-196L650NW-G2-3-UNV-DMG-BKTX

Series	LED module	Gen.	Optical system	Voltage	Driver options ²	Adapters	Options				Poles/ Brackets	Finish
							Receptacle	Control	Luminaire	Decorative		
AT50-C Ancestra LED pendant	3000K	G2 Gen 2	1 Type I (ASYM)	UNV 120-277VAC	DMG 0-10V SRD ³ Sensor ready driver, standard configuration	MA1 1 1/4" NPT threaded hole adapter accepting threaded tube	RC ⁶ Receptacle for twist-lock photocell or shorting cap, 3-pin	PH7 ⁴ PH8 ⁵ Twist-lock Photoelectric Cell	SP2 20kV/10kA Surge Protector (optional)	CR20 Decorative Crown	Visit us online at Signify.com/luminaires for details and the complete line of poles and brackets.	Textured
	196L450WW ¹											
	196L650WW ¹	2 Type II (ASYM)	347VAC	SRD ³ Sensor ready driver, standard configuration	MA2 1 1/2" NPT threaded hole adapter accepting threaded tube	RCD ⁶ Receptacle for twist-lock photocell or shorting cap, 5-pin	PHXL ³ Twist-lock Photoelectric Cell, extended life, UNV (120-277VAC)	CR30 Decorative Crown	CR40 Decorative Crown			
	196L1150WW											
	196L1675WW	3 Type III (ASYM)	480VAC	SRD1 ³ Sensor ready driver, alternate configuration	SMA Decorative retro side-mounted cast-aluminum, accepts tubes from 1-5/8" to 2-3/8"	RCD7 ^{6,7} Receptacle for twist-lock photocell or shorting cap, 7-pin	PH9 ⁵ Shorting cap	DA Decorative Arches	DC Decorative Cap			
	196L2100WW											
	4000K	4 Type IV (ASYM)	480VAC	SRD1 ³ Sensor ready driver, alternate configuration	SMA Decorative retro side-mounted cast-aluminum, accepts tubes from 1-5/8" to 2-3/8"	RCD7 ^{6,7} Receptacle for twist-lock photocell or shorting cap, 7-pin	PH9 ⁵ Shorting cap	DA Decorative Arches	DC Decorative Cap	GRD Decorative Cap		
	196L450NW ¹											
	196L650NW ¹											
	196L1150NW											
	196L1675NW											
	196L2100NW	5 Type V (SYMM)	480VAC	SRD1 ³ Sensor ready driver, alternate configuration	SMB Decorative contemporary side-mounted cast-aluminum, accepts tubes from 1-5/8" to 2-3/8"	RCD7 ^{6,7} Receptacle for twist-lock photocell or shorting cap, 7-pin	PH9 ⁵ Shorting cap	DA Decorative Arches	DC Decorative Cap	GRD Decorative Cap		
	196L450NW ¹											
	196L650NW ¹											
	196L1150NW											
196L1675NW												
196L2100NW												

1. For 240 or 277 volt with **CDMG** options consult factory.
 2. Select either **CDMG** or **DMG** or **DALI** mandatory option.
 3. Not available with **347C** and **480V**.
 4. Not available with **480V**.
 5. Options for **RC**, **RCD** or **RCD7** must be selected with this configuration.
 6. Use of photoelectric cell or shorting cap is required to ensure proper illumination.
 7. The **SMB** adapter is required for this option.

AT50 Ancestra LED Pendant

Urban luminaire with comfort optics

Dimensions

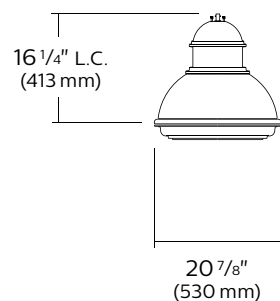

AT50-C

EPA: 1.35 sq.ft.
Weight: 35.5 lbs. (16.1 kg)

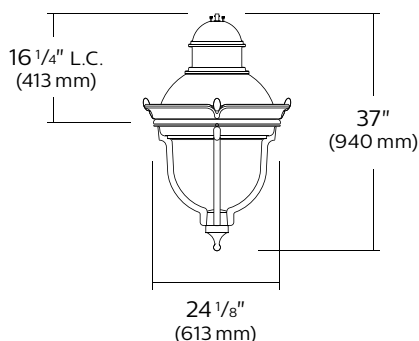

AT50-C
(shown w/CR30 & GRD)

EPA: 1.58 sq.ft.
Weight: 51.5 lbs. (23.3 kg)

Models



3000K Lumen Values

Ordering Code	Total LEDs	LED current (mA)	Ave. System Wattage (W)	Type 1			Type 2			Type 3		
				Lumen Output	Efficacy (LPW)	BUG Rating	Lumen Output	Efficacy (LPW)	BUG Rating	Lumen Output	Efficacy (LPW)	BUG Rating
AT50-C-196L450830-G2-x	196	450	21	1916	91	B1-U0-G1	1930	92	B1-U0-G1	2029	97	B1-U0-G1
AT50-C-196L650830-G2-x	196	650	30	2709	90	B1-U0-G1	2729	91	B1-U0-G1	2869	96	B1-U0-G1
AT50-C-196L1150830-G2-x	196	1150	52	4735	91	B2-U0-G2	4769	92	B2-U0-G2	5014	96	B2-U0-G2
AT50-C-196L1675830-G2-x	196	1675	75	6556	87	B3-U0-G3	6604	88	B2-U0-G2	6942	93	B2-U0-G2
AT50-C-196L2100830-G2-x	196	2100	94	7998	85	B3-U0-G3	8056	86	B3-U0-G3	8469	90	B3-U0-G3

Ordering Code	Total LEDs	LED current (mA)	Ave. System Wattage (W)	Type 4			Type 5		
				Lumen Output	Efficacy (LPW)	BUG Rating	Lumen Output	Efficacy (LPW)	BUG Rating
AT50-C-196L450830-G2-x	196	450	21	2110	100	B1-U0-G1	1976	94	B1-U0-G1
AT50-C-196L650830-G2-x	196	650	30	2984	99	B1-U0-G1	2794	93	B2-U0-G1
AT50-C-196L1150830-G2-x	196	1150	52	5214	100	B2-U0-G2	4883	94	B3-U0-G1
AT50-C-196L1675830-G2-x	196	1675	75	7219	96	B2-U0-G2	6761	90	B3-U0-G2
AT50-C-196L2100830-G2-x	196	2100	94	8808	94	B3-U0-G3	8248	88	B3-U0-G2

4000K Lumen Values

Ordering Code	Total LEDs	LED current (mA)	Ave. System Wattage (W)	Type 1			Type 2			Type 3		
				Lumen Output	Efficacy (LPW)	BUG Rating	Lumen Output	Efficacy (LPW)	BUG Rating	Lumen Output	Efficacy (LPW)	BUG Rating
AT50-C-196L450840-G2-x	196	450	21	1993	95	B1-U0-G1	2007	96	B1-U0-G1	2110	100	B1-U0-G1
AT50-C-196L650840-G2-x	196	650	30	2818	94	B2-U0-G2	2838	95	B1-U0-G1	2984	99	B1-U0-G1
AT50-C-196L1150840-G2-x	196	1150	52	4924	95	B2-U0-G2	4960	95	B2-U0-G2	5214	100	B2-U0-G2
AT50-C-196L1675840-G2-x	196	1675	75	6818	91	B3-U0-G3	6868	92	B3-U0-G3	7220	96	B2-U0-G2
AT50-C-196L2100840-G2-x	196	2100	94	8318	88	B3-U0-G3	8379	89	B3-U0-G3	8808	94	B3-U0-G3

Ordering Code	Total LEDs	LED current (mA)	Ave. System Wattage (W)	Type 4			Type 5		
				Lumen Output	Efficacy (LPW)	BUG Rating	Lumen Output	Efficacy (LPW)	BUG Rating
AT50-C-196L450840-G2-x	196	450	21	2194	104	B1-U0-G1	2055	98	B1-U0-G1
AT50-C-196L650840-G2-x	196	650	30	3103	103	B1-U0-G1	2906	97	B2-U0-G1
AT50-C-196L1150840-G2-x	196	1150	52	5423	104	B2-U0-G2	5078	98	B3-U0-G1
AT50-C-196L1675840-G2-x	196	1675	75	7508	100	B2-U0-G2	7031	94	B3-U0-G2
AT50-C-196L2100840-G2-x	196	2100	94	9160	97	B2-U0-G2	8578	91	B3-U0-G2

Actual performance may vary due to installation variables including optics, mounting/ceiling height, dirt depreciation, light loss factor, etc.; highly recommended to confirm performance with a layout - contact Applications at signify.com/outdoorluminaires. Consult DLC QPL to confirm your specific fixture selection is DLC approved. Note: Some data may be scaled based on tests of similar but not identical luminaires.

AT50 Ancestra LED Pendant

Urban luminaire with comfort optics

Specifications

Housing

Hood: Spun aluminum 1100 0 dome, mechanically assembled on the luminaire.

Housing: In a round shape, this housing is made of cast 356 aluminum, c/w a watertight grommet, mechanically assembled to the bracket with four bolts 3/8 16 UNC. This suspension system permits for a full rotation of the luminaire in 90° increments.

Access-mechanism

A die cast A360 aluminum technical ring with latch, hinge and a cast in decorative skirt. The mechanism shall offer tool free access to the inside of the luminaire. An embedded memory retentive gasket shall ensure weatherproofing.

Light engine

Light guide technology provides low-glare, uniform illumination. Composed of 196 LEDs strategically positioned on the edge of the optical plate. Light engine luminous opening size optimized to best achieve a balance between lumen output and optical performance with the need to provide visual comfort. Light engine frame ensures contact with housing to provide heat conduction and sealing against the elements. Light engine is RoHS compliant. Maximum ambient operating temperature up to 40°C(104°F). Standard color temperatures: 3000K +/- 130K, 4000K+/-130K, Minimum CRI of 80. Also available in 2700K, 3500K, 5000K and Amber (>590nm) with extended lead times. Contact factory for details.

Optical System

The advanced LED comfort optical system provides Types 1, 2, 3, 4 and 5. Composed of high performance UV-stabilized optical grade lens with molded micro-optics to achieve desired distribution optimized to get a exceptional lighting uniformity. Performance tested per LM-79 and TM-15 (IESNA) certifying its photometric performance. Street side indicated luminaire designed with 0% uplight (U0 per IESNA TM-15).

Driver

High power factor of 95%. Electronic driver, operating range 50/60 Hz. Auto adjusting universal voltage input from 120 to 277 and 347 to 480 VAC rated or both application line to line or line to neutral, Class 2, THD of 20% max. Maximum ambient operating temperature from 40°F (40°C) to 130°F (50°C). Certified in compliance to UL1310 cULus requirement. Dry and damp location. Assembled on a unitized removable tray with Tyco quick disconnect plug resisting to 221°F (105°C). Dimmable driver 0-10V. The current supplying the LEDs will be reduced by the driver if the driver experiences internal overheating as a protection to the LEDs and the electrical components. Output is protected from short circuits, voltage overload and current overload. Automatic recovery after correction. Standard built in driver surge protection of 2.5kV (min) with CDMG, driver is class 1.

Surge Protection

Surge protector tested in accordance with ANSI/IEEE C62.45 per ANSI/IEEE C62.41.2 Scenario I Category C High Exposure 0kV/10kA waveforms for Line Ground, Line Neutral and Neutral Ground, and in accordance with U.S. DOE (Department of Energy) MSSLC (Municipal Solid State Street Lighting Consortium) model specification for LED roadway luminaires electrical immunity requirements for High Test Level 10kV / 10kA. SP2 20kV/10kA optional.

Driver options

DMG: Dimmable driver 0-10V.

SRD: Sensor Ready Driver including SR communication (used for dimming and other functionalities), 24V auxiliary supply and a logical signal input (LSI) connected to the top NEMA twist lock receptacle.

SRD1: Sensor Ready Driver including SR communication (used for dimming and other functionalities) but with 24V auxiliary supply and a logical signal input (LSI) not connected to the top NEMA twist lock.

Wiring

Gauge (#14) TEW/AWM 1015 or 1230 wires, 6" (152mm) minimum exceeding from luminaire.

Hardware

All exposed screws shall be complete with Ceramic primer-seal base coat to reduce seizing of the parts and offers a high resistance to corrosion. All seals and sealing devices are made and/or lined with EPDM and/or silicone and/or rubber.

LED products (manufacturing standard)

The electronic components sensitive to electrostatic discharge (ESD) such as light emitting diodes (LEDs) are assembled in compliance with IEC61340 5 1 and ANSI/ESD S20.20 standards so as to eliminate ESD events that could decrease the useful life of the product.

Quality control

Manufactured to ISO 9001 2015 standards and ISO 14001-2004 International Quality Standards Certification.

Certifications and Compliance

cULus Listed for Canada and USA.

Luminaires are DesignLights Consortium qualified.

Predicted Lumen Depreciation Data

Predicted lumen depreciation data ¹				
Ambient Temperature (°C)	Driver (mA)	Calculated L ₇₀ hours ^{1,2}	L ₇₀ per TM-21 ^{2,3}	Lumen Maintenance % @ 60,000 hours
25°C	up to 2100 mA	>100,000	>60,000	83%

1. Predicted performance derived from LED manufacturer's data and engineering design estimates, based on IESNA LM-80 methodology. Actual experience may vary due to field application conditions.

2. L₇₀ is the predicted time when LED performance depreciates to 70% of initial lumen output.

3. Calculated per IESNA TM21-11. Published L₇₀ hours limited to 6 times actual LED test hours.

AT50 Ancestra LED Pendant

Urban luminaire with comfort optics

Specifications (continued)

Luminaire adapter

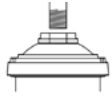

MA1: The luminaire is suspended by means of a mounting adaptor with a 1" (32mm) NPT threaded hole accepting a threaded tube from the mounting. Retrofit adaptor for existing mounting.



MA2: MA2: 1." (38mm) NPT threaded hole accepting threaded tube from the mounting. Retrofit adaptor for existing mounting.

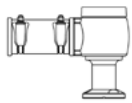

SMB: The luminaire is suspended by means of a decorative side-mounted cast aluminum adaptor. This adaptor accepts tubes from 1⁵/₈" to 2³/₈" (41 to 60 mm) and is adjustable to more or less 5°.

Decorative options

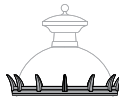

CR20
Decorative Crown

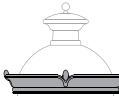

CR30
Decorative Crown



CR40
Decorative Crown



DA
Decorative arches



DC
Decorative cap



GRD
Decorative guard

Luminaire options

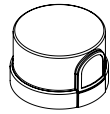

PH7
Photoelectric cell, bottom type



PH8
Photoelectric cell, twist-lock type. Allows 90° rotation

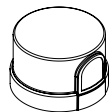

PH9
Shorting cap, twist-lock type

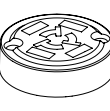

PHXL
Extended life Photoelectric cell, twist-lock type. Allows 90° rotation

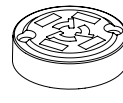

RCD
Receptacle 5-pins

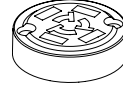

RCD7
Receptacle 7-pins

SP2
20kV/10kA integral surge protector (optional)

Fitter

Cast 356 aluminum c/w 4 set screws 3/8 16 UNC. This fitter holds 2 arms made of cast aluminum 356 mechanically assembled. Slip fits on a 4" (102mm) outside diameter X 4" (102mm) long tenon.

Finish

In accordance with the AAMA 2603 standard. Application of polyester powder coat paint (4 mils/100 microns) with +/- 1 mils/24 microns of tolerance. The Thermosetting resins provides a discoloration resistant finish in accordance with the ASTM D2244 standard, as well as luster retention in keeping with the ASTM D523 standard and humidity proof in accordance with the ASTM D2247 standard. The surface treatment achieves a minimum of 2000 hours for salt spray resistant finish in accordance with testing performed and per ASTM B117 standard.

Textured Finish Options:

BE2TX: Textured Midnight Blue
BE6TX: Textured Ocean Blue
BE8TX: Textured Royal Blue
BG2TX: Textured Sandstone
BKTX: Textured Black
BRTX: Textured Bronze
GN4TX: Textured Blue Green
GN6TX: Textured Forest Green
GN8TX: Textured Dark Forest Green
GNTX: Textured Green
GY3TX: Textured Medium Grey
RD2TX: Textured Burgundy
RD4TX: Textured Scarlet
WHTX: Textured White

Non-Textured Finish Options:

GR: Gray Sandtex
NP: Natural Aluminum
TG: Hammer-tone Gold

AT50 Ancestra LED Pendant

Urban luminaire with comfort optics

Poles

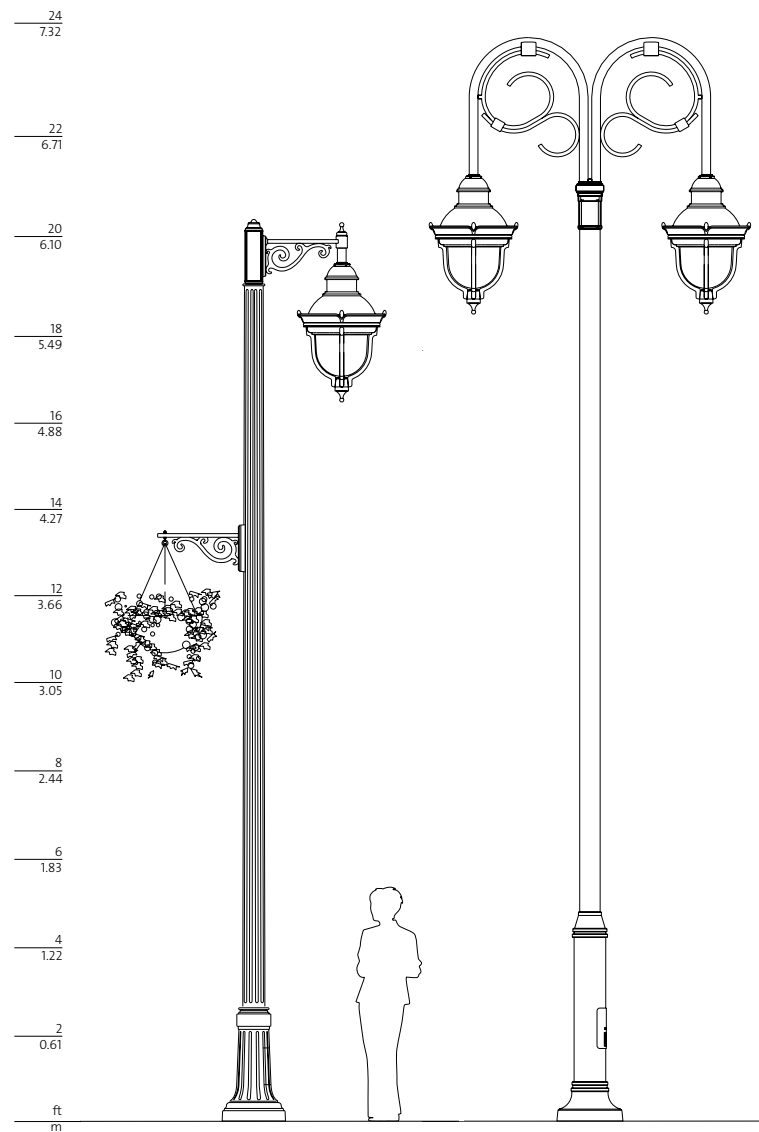

AT50-C-GRD-CR30
Mounting: CRAT-1A
Pole: RTA906/907-PSCRA

AT50-C-GRD
Mounting: RM-2
Pole: SSM8



© 2023 Signify Holding. All rights reserved. The information provided herein is subject to change, without notice. Signify does not give any representation or warranty as to the accuracy or completeness of the information included herein and shall not be liable for any action in reliance thereon. The information presented in this document is not intended as any commercial offer and does not form part of any quotation or contract, unless otherwise agreed by Signify.

Signify North America Corporation
400 Crossing Blvd, Suite 600
Bridgewater, NJ 08807
Telephone: 800-555-0050

Signify Canada Ltd.
281 Hillmount Road,
Markham, ON, Canada L6C 2S3
Telephone: 800-668-9008

All trademarks are owned by Signify Holding or their respective owners.