



ArcForm Duo is the next generation of excellence in Architectural Recessed luminaires with two choices for optics: the high performance MesoOptics lens or the value driven Silk lens. Meet the perfect duo.

ArcForm Duo includes AccuRender technology for the highest color quality at the highest efficacy.

Project: _____
 Location: _____
 Cat.No: _____
 Type: _____
 Line ID: _____ Qty: _____
 Notes: _____

Ordering guide

QuickShip options

Tunable White options

Example: AF22D1STL93545Q1DSNCS

Family	Size	Version	Configuration	Source	CRI/CCT ^{1,3}	Lumens ^{1,3}	Optics	Wiring ^{2,7}
AF			ST	L				
AF ArcForm Duo	22 2'x2' 14 1'x4'	D1 Standard & Slot T-Grid C1 Standard & Slot T-Grid + Chicago Plenum	ST Standalone	L LED	940 CRI 90, 4000K 935 CRI 90, 3500K 930 CRI 90, 3000K 950 CRI 90, 5000K 927 CRI 90, 2700K	50 5000lm 45 4500lm 40 4000lm 35 3500lm 30 3000lm 25 2500lm 20 2000lm	A Silk - Lambertian Q MesoOptics - Batwing	1 1 Circuit B 1 Circuit + Battery Pack G 1 Circuit + GTD 120V H 1 Circuit + GTD 277V
	24 2'x4'				9T2 CRI 90, 2700-6500K 2ch Tunable White	80 8000lm 75 7500lm 70 7000lm 65 6500lm 60 6000lm 55 5500lm 50 5000lm 45 4500lm 40 4000lm		
Voltage ⁴	Driver (Dim %)	Option	Integral Sensors & Control System					
D UNV 120-277V 3 347V	E Advance Xitanium 0-10V (1%) D Advance Xitanium DALI-2 D4i (1%) H Lutron EcoSystem LDE1 (<1%, FtB)	N None P Pre-Installed Flex Whip (6', 6C)	Leave blank					
	D UNV 120-277V	S Advance Xitanium SR, DALI-2 D4i (1%)	CS Interact Pro Sensor (Day/Occ) RA Interact Pro Radio Node SB Interact Pro Enterprise Sensor Bundle (Day/Occ + IoT) AS Lutron Athena Sensor AWNS (Day/Occ) AR Lutron Athena Radio Node AWNR VS Lutron Vive Sensor VDO (Day/Occ) VR Lutron Vive Radio Node VRF					
D UNV 120-277V	A Advance Xitanium 0-10V + Aux (1%)	DO Basic Daylight and Occupancy AS Lutron Athena Sensor AWNS (Day/Occ) AR Lutron Athena Radio Node AWNR						
D UNV 120-277V	F Advance FlexTune 2ch SR, DALI DT8 (1%)	CS Interact Pro Sensor (Day/Occ) RA Interact Pro Radio Node SB Interact Pro Enterprise Sensor Bundle (Day/Occ + IoT) AS Lutron Athena Sensor AWNS (Day/Occ) AR Lutron Athena Radio Node AWNR						
	2 0-10V 2ch (0.1%)	AS Lutron Athena Sensor AWNS (Day/Occ) AR Lutron Athena Radio Node AWNR						

- Nominal values within a range. Some lumen packages not available in all configurations, consult photometry data for CRI/CCT (static & tunable white), lumens & distribution of chosen configuration.
- Not all wiring types are available with all configurations. Consult Ledalite for a complete list of available options.
- Tunable White available with Advance FlexTune 2ch SR and 0-10V 2ch drivers. Consult factory for alternatives such as DALI DT8 or DMX (extended lead times may apply). Tunable White max lumen package is 5000lm.

- 347V only available with E - Advance Xitanium 0-10V (1%) driver option
- Interact Pro options may require an IRT9015 Interact commissioning remote or other separate controls hardware by Signify.
- Other options not shown here may also be possible via a custom request, please consult factory. Extended lead times and minimum order quantities may apply.
- GTD is only available with E, D, or H driver options with either a 120V or 277V connection.

Note: Due to continuing product improvements, Ledalite reserves the right to change the specifications without notice.

ArcForm Duo Architectural Recessed

Mounting details

Standard T-Grid

Integrates with most common T-Grid types. Works with 9/16" & 15/16" flat T-Grid ceilings.

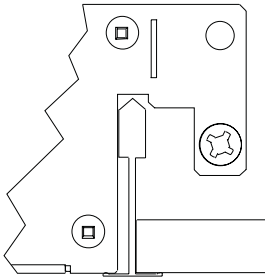

Slot T-Grid

Can be used with slot T-Grid ceilings. For 9/16" slot T-Grid ceilings, fixture will sit 5/16" above bottom of T-Bar.

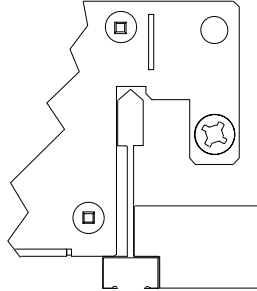

Drywall Trim Mounting Frame

The Ledalite drywall trim mounting frame assembly is designed to permit use of grid (NEMA G) fixtures in drywall or ceilings requiring flanges. Mounting frame is ordered separately and compatible with standalone recessed product. Frame can be installed directly to a solid frame (such as wood) or via hanger wires. Finish is white.

Extruded aluminum construction with mitered corners. Includes screws for complete assembly. Available in 2'x2', 2'x4' & 1'x4' sizes.

Drywall Frame Ordering Code	Size
300DK02	1'x4'
300DK03	2'x2'
300DK04	2'x4'

More information available [here](#).

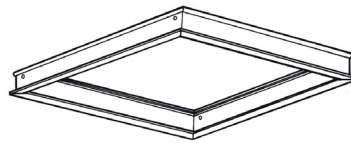

Wood Frame Hanger Wire

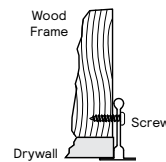

Wood frame and screws supplied by others.

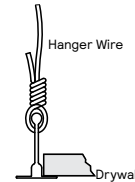

Hanger wires supplied by others.

ArcForm Duo Architectural Recessed

Dimensions

2'x2' lens view, with and without Interact sensor*

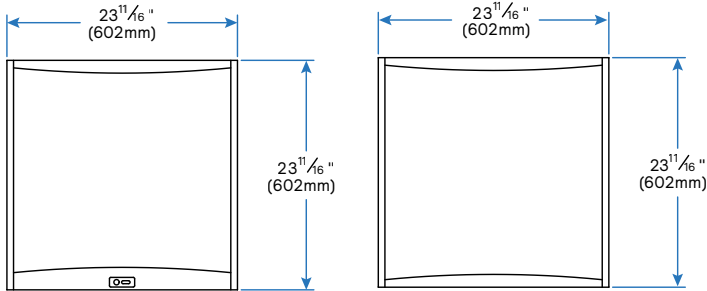

2'x4' lens view, with and without Interact sensor*

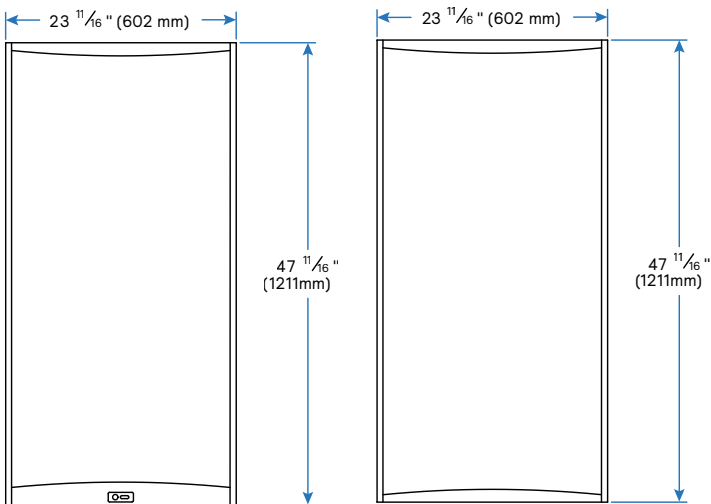

1'x4' lens view, with and without Interact sensor

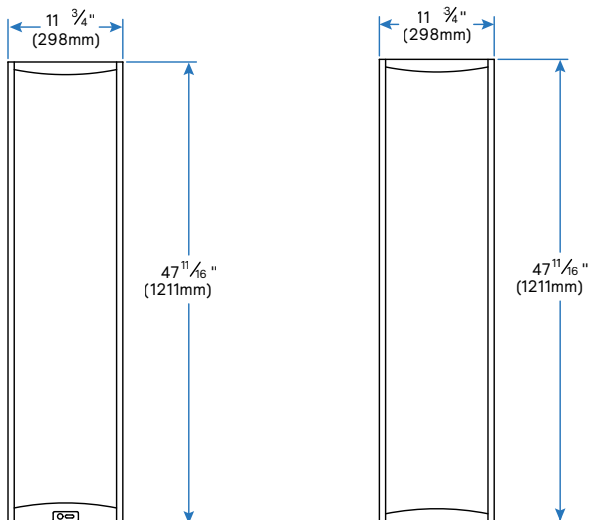

End view

Standard version

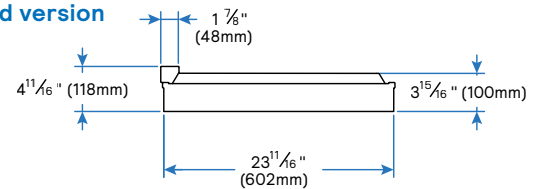

Battery pack and GTD version

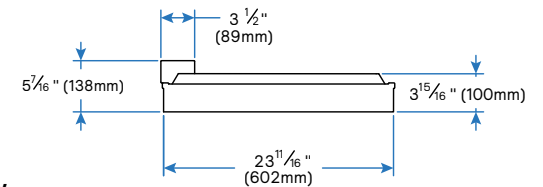

End view

Standard version

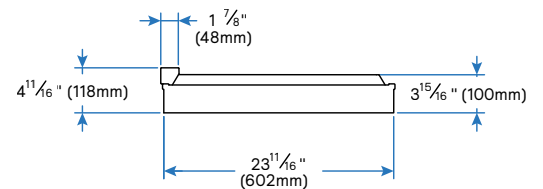

Battery pack and GTD version

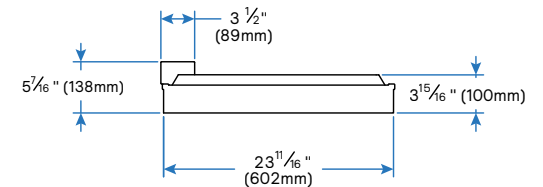

End view

Standard version

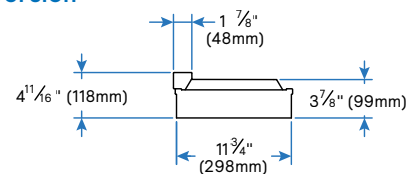

Battery pack and GTD version

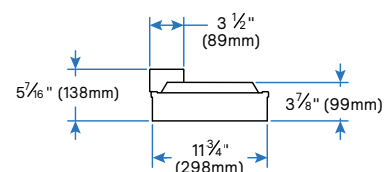

*All other sensors such as Lutron Athena or Vive have the same placement.

ArcForm Duo Architectural Recessed

Specifications

Optical System

MesoOptics – Batwing: A layer of precision MesoOptics film creates a batwing distribution resulting in a flawless uniform surface while allowing for higher on-center spacing, promoting even lighting on the workplane and reduced glare, resulting in the need for less luminaires than typical troffer applications and providing superior user comfort in spaces.

Silk – Lambertian: A diffuse white acrylic lens delivers a flawlessly uniform luminous surface with a light distribution typical of troffer type lighting applications.

Housing

Product is compatible with NEMA Type G, NFG, NFSG, and SS. Sides and center spine: precision aluminum extrusion; end caps, back housing and driver cover: die-formed, cold-rolled steel, pre and post painted.

Finish

Extruded aluminum trim and formed steel coated with an electrostatically applied, thermally cured polyester powder coat sandtex white finish. Driver box is galvanized.

Mounting

Compatible with 15/16" lay-in acoustical ceilings using exposed grid suspension (NEMA type G). For 9/16" slot T-grid ceilings, fixture will sit 5/16" above bottom of Tee. Optional drywall kit trim mount can be fastened to a wood frame or with hangar wire.

Weight

Size	Typical	Maximum
2'x2'	11 lbs.	13 lbs.
2'x4'	19 lbs.	22 lbs.
1'x4'	12 lbs.	15 lbs.

Electrical & Servicing

Drivers are easily field replaceable from above the ceiling with the unique Duo driver box design. Wire knock-outs available on both ends of the driver box for field-installable mains and dimming thru-wiring across multiple fixtures. Optional armored 6-conductor cable flex whips are available in 6' lengths (option code P).

Integral Battery Packs and GTDs

Bodine Battery Pack, 90 min, 10W, Class 2 rated output. Low profile test switch is easily accessible from below the ceiling.

Battery pack lumen output = 10W x luminaire efficacy x 1.1. Typical output: 1600lm.

Bodine GTD (generator transfer device) is for use with a generator or central inverter. Requires connection to an emergency source derived from a UL 1008 Listed transfer switch.

Lumen Maintenance

LEDs have been tested by the manufacturer in accordance with IESNA LM-80-08. At an ambient temperature of 25°C, the LED lumen maintenance expectation according to IES TM-21-11:

L_{70} (17K) >102,000 hrs (Reported methodology).

The below calculated lifetime represents estimations commonly used. PS-10-18: IES Position on LED Product Lifetime Prediction, explains proper use of IES TM-21 and LM-80.

L_{70} > 215,000 hrs (Calculated).

Source Color

LEDs rated for color rendering of:

$CRI R_a \geq 90, R_g \geq 50, G_a \geq 97, C_g \geq 90$

IES TM-30-18 : $R_f \geq 89, R_{f,h1} \geq 88, R_g \geq 97, R_{cs,h1} \geq -6\%$

SPD and TM-30-18 reports available upon request

Fixture to fixture color accuracy within 3 SDCM

Approvals

Certified to UL, CSA, & IES standards.

City of Chicago Approved CCEA (Version C1).

Type IC Rated.

Luminaires that include Interact Pro controls options can help meet the requirements in 90.1-2022, IECC 2021, and CA T24 2022 for a maximum of 20 min. time out for occupancy controls.

Environment

Rated for dry or damp locations in operating ambient temperatures of 25±5°C (77±9°F).

Many luminaire components, such as reflectors, refractors, lenses, and LEDs are made from various types of plastics which can be adversely affected by airborne contaminants. If sulfur-based chemicals, petroleum-based products, cleaning solutions, or other contaminants are expected in the intended area of use, consult factory for compatibility. Damage caused by sulfur, chlorine, petroleum-based solution or other contaminants are not covered under warranty. Not suitable for natatorium environments.

Warranty

Standard five-year luminaire limited warranty including LED light engine and driver. Warranties up to 10 years are available upon special request. Visit www.signify.com/warranties under "Indoor Professional Luminaires" for more information.

QuickShip

10-day QuickShip available for thousands of configurations when requested at ordering time. This service is offered at no additional charge. More information available [here](#).

ArcForm Duo Architectural Recessed

Specifications (continued)

Drivers

Class 2 rated output. Lowest dimming level shown in brackets. Consult Ledalite for other available drivers or custom requests.

Static White 120-277V

- Advance Xitanium 0-10V (1%)
- Advance Xitanium DALI-2 D4i (1%)
- Advance Xitanium SR (Sensor Ready), DALI-2 D4i (1%)
- Advance Xitanium 0-10V + Aux (1%)
- Lutron EcoSystem LDE1 (<1%, Soft-on, Fade-to-Black)

Static White 347V

- Advance Xitanium 0-10V (1%)
- Advance Xitanium SR, DALI-2 D4i (1%) – Contact Factory

Tunable White 2-channel 120-277V

- Advance FlexTune 2ch SR (Sensor Ready), DALI DT8 (1%)
- 0-10V 2ch (0.1%)
- DALI-2 DT6 2ch (0.1%) – Contact Factory
- DALI-2 DT8 2ch (0.1%) – Contact Factory

WELL v2 Building Standard

ArcForm Duo luminaires contribute towards satisfying the following features under the WELL v2 Building Standard:

- **L03:** When specified with a Tunable White system.
- **L04:** Glare management for configurations at <19 UGR and <16 UGR.
- **L07:** Brightness management with batwing distributions allowing for even lighting within a space, while spacing the fixtures wider apart than typical recessed luminaire product.
- **L08:** AccuRender CRI 90 standard LED boards with high performance Advance Xitanium drivers (or optional drivers) to manage color quality and flicker
- **L09:** When specified with Interact or when tied to a 3rd party control system.

Controls

Detailed specification of controls can be found on the following pages of this spec sheet. Ordering codes shown in brackets. Many 3rd party control solutions can be used separate of the luminaire when the correct driver is specified (i.e. 0-10V, DALI, EcoSystem). Consult Ledalite for other integral sensors, remote sensors, and custom requests such as those from Enlighted, Encelium, Wattstopper, or others.

Wireless & Connected Controls

- Interact Pro Radio Node (RA)
- Interact Pro Connected Sensor (CS)
- Interact Pro Enterprise Sensor Bundle (SB)
- Lutron Athena Sensor AWNS (AS)
- Lutron Athena Node AWRN (AR)
- Lutron Vive Sensor VDO (VS)
- Lutron Vive Node VRF (VR)

Discrete Controls

- Basic Daylight and Occupancy (DO)

ArcForm Duo Architectural Recessed

Controls Options*

Interact Radio Node for Standalone, Gateway and Gateway + IoT tiers (RA)

- RA is a connected radio node supporting wireless mesh connectivity.

Interact sensor for Standalone, Gateway and Gateway + IoT tiers (CS)

- CS is a connected sensor with integral occupancy and daylight sensing and supports wireless mesh connectivity.
- The sensor can operate in a standalone mode or in a gateway mode.
- Interact includes an App, a portal and a broad portfolio of wireless luminaires, lamps and retrofit kits all working on the same system.
- Startup is implemented via Interact Pro app (Android or iPhone) & Bluetooth connectivity. The app provides flexibility to choose between a gateway or non gateway mode for setup.
- Setup with the gateway requires wired internet access to the gateway.
It is possible to add a gateway at a later point.
- Prepare project configuration steps remotely and use IRT9015 remote onsite to identify and group devices together.
- Compatible with UID8465/10 or UID8465/50 wireless dimmer switches, wireless dimmer switch, SWS200 wireless scene switch, wireless occupancy sensor (OCC0100A/02 BP Sensor WH) and wireless daylight /occupancy sensor (OCC0101A/02 DL BP Sensor WH).
- For more information on Interact visit:
www.interact-lighting.com/en-us/what-is-possible/about-interact

Interact sensor bundles for Gateway + IoT tier (SB)

- SB option, in addition to occupancy and daylight sensing, supports advanced IoT capabilities such as people estimation analysis, desk level temperature & humidity sensing, noise classification, and Bluetooth Low Energy (BLE) beacon.
- Compatible with UID8465/10 or UID8465/50 wireless dimmers switches, SWS200 wireless scene switch, wireless occupancy sensor (OCC0100A/02 BP Sensor WH) and wireless daylight/occupancy sensor (OCC0101A/02 DL BP Sensor WH).
- Use Interact software and insights to increase building efficiency, achieve building wide integration and optimize space through occupancy analytics.
- Requires compatible gateway and internet connectivity for commissioning. For more information, visit: www.interact-lighting.com/office

Tunable White & BioUp

- Tunable white options are available with Interact wireless, Lutron Athena wireless, and 2ch 0-10V wired drivers. Please inquire about BioUp options and driver options such as DALI-2 DT6 or DMX control (extended lead times may apply).
- Signify tunable white solutions are designed to help maximize the influence of lighting on your daily life.
- Signify BioUp helps support daytime circadian rhythm for engagement during the day and good sleep quality at night.
- Dynamic behaviors via scheduled lighting recipes mimicking daylight patterns or supporting biorhythms.
- Scene setting via lighting pre-sets based on various combinations of lighting color temperature and intensity.

Interact Pro scalable sensor option codes across Genlyte product lines*

	Evokit	Day-Brite	Ledalite	Lightolier
Zigbee + Bluetooth	RADIO	RADIO	RA	RA
Zigbee + Bluetooth + Sensing	SWZCS	SWZCS	CS	SBA accessory (external)
Zigbee + Bluetooth + Sensing + Environmental data	IAOSB	IAOSB	SB	SB
Zigbee + Highbay + Sensing	-	SWZCSH	-	-

ArcForm Duo Architectural Recessed

Functionalities overview

	The three tiers of Interact		
	Standalone	Gateway	Gateway + IoT
Dimming, grouping, and zoning	✓	✓	✓
Bluetooth and ZigBee enabled	✓	✓	✓
Motion sensing and daylight harvesting	✓	✓	✓
Integration with 0-10V and phase dimming fixtures	✓	✓	✓
Code compliance	✓	✓	✓
Granular dimming and dwell time	✓	✓	✓
New Correlated color temperature (CCT) tuning by switch	✓	✓	✓
New Support for sensor-based Tunable White luminaires	✓	✓	✓
Energy reporting and monitoring		✓	✓
Scheduling		✓	✓
Demand response		✓	✓
BMS integration (BACnet)			✓
Floor plan visualization			✓
IoT sensors for wellness			✓
IoT Apps for productivity			✓

Currently supported maximum system size

To be able to design the lighting system correctly for the customer, it is important to know the prime characteristics of the system, its possibilities and limitations.

System level	
Total number of gateways	Unlimited
Total number of devices	200 per network
• luminaires with integrated sensors	150
• smart TLEDs	150
Total number of ZGP devices (sensors and switches)	50
• sensors	30
• switches	50
• zones and groups	64
Group level	
Recommended number of lights	40 (recommended 25)
Number of ZGP devices	5
Number of scenes	16

Interact system architecture for office, education, healthcare, retail, industrial and parking applications

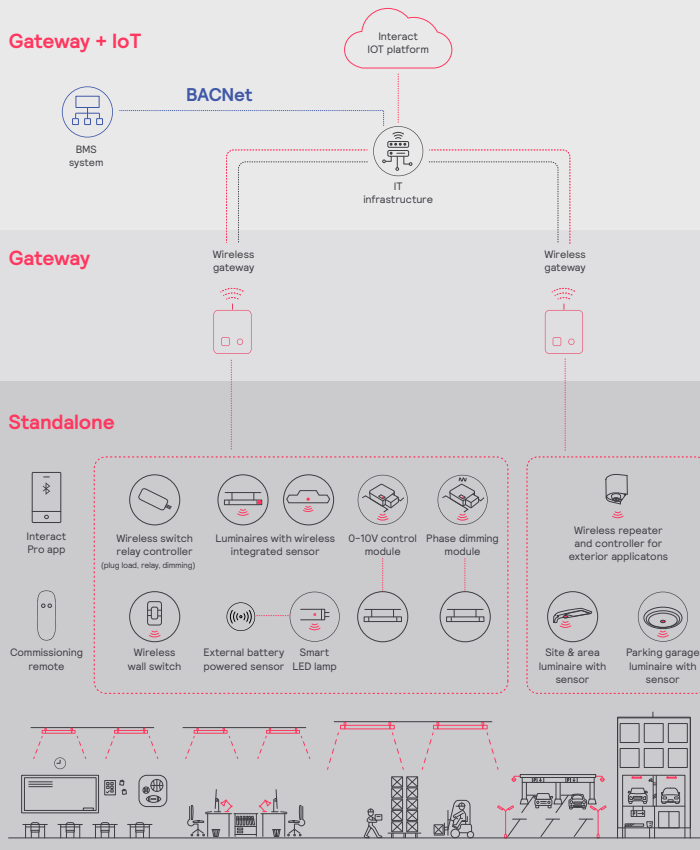

ArcForm Duo Architectural Recessed

Colorimetry

ArcForm Duo – AccuRender Static White

Nominal CRI & CCT		CRI 90+, 2700K	CRI 90+, 3000K	CRI 90+, 3500K	CRI 90+, 4000K	CRI 90+, 5000K
CIE 013.3-1995 ¹	CRI R _a	93	94	92	93	94
	R ₉	56	67	59	63	74
	G _a	99	100	99	97	97
	C ₉	93	94	93	93	95
IES TM-30-18 ²	R _f	90	91	90	89	89
	R _{f,h1}	88	91	89	88	89
	R _g	100	100	100	97	98
	R _{cs,h1}	-6%	-5%	-6%	-6%	-5%
MDER ³		0.44	0.50	0.56	0.65	0.83

ArcForm Duo – AccuRender Tunable White

Nominal CRI & CCT		CRI 90+, 2700K	CRI 90+, 3000K	CRI 90+, 3500K	CRI 90+, 4000K	CRI 90+, 5000K	CRI 90+, 6500K
CIE 013.3-1995 ¹	CRI R _a	93	94	95	95	94	92
	R ₉	58	67	77	83	84	72
	G _a	98	99	100	100	98	95
	C ₉	93	94	96	97	97	94
IES TM-30-18 ²	R _f	90	90	90	89	89	87
	R _{f,h1}	89	90	90	90	89	86
	R _g	98	99	99	98	98	95
	R _{cs,h1}	-6%	-5%	-4%	-4%	-4%	-6%
MDER ³		0.44	0.52	0.63	0.71	0.84	0.99

1. Color Rendering Index (CRI Ra) and Strong Red (R9) are calculated in accordance with CIE 013.3-1995. Color Gamut index (Ga) and red chroma Index (C9) are CIE based properties using the Global Lighting Association's calculation tool.
2. Fidelity Index (Rf), Red Fidelity Index (Rf,h1), Gamut Index (Rg), and Red Local Chroma Shift (Rcs,h1) are calculated in accordance with IES TM-30-18.-18.
3. Melanopic Daylight Efficacy Ratio (MDER) is the measure for "spectral melanopic efficiency" as defined in CIE S 026-2018.

ArcForm Duo Architectural Recessed

Photometry

ArcForm Duo 2'x2' Silk (Lambertian)

Click "PDF" or "IES" text to download

Nominal CRI & CCT		CRI 90+, 2700K					CRI 90+, 3000K					CRI 90+, 3500K					CRI 90+, 4000K					CRI 90+, 5000K					CRI 90+, 6500K						
Lumen Package	Watts (W)	Flux (lm) ¹	Efficacy (LPW) ¹	UGR ²	Photometry Report	IES File	Flux (lm) ¹	Efficacy (LPW) ¹	UGR ²	Photometry Report	IES File	Flux (lm) ¹	Efficacy (LPW) ¹	UGR ²	Photometry Report	IES File	Flux (lm) ¹	Efficacy (LPW) ¹	UGR ²	Photometry Report	IES File	Flux (lm) ¹	Efficacy (LPW) ¹	UGR ²	Photometry Report	IES File	Flux (lm) ¹	Efficacy (LPW) ¹	UGR ²	Photometry Report	IES File		
Static White	5000	35	4902	140	22	PDF	IES	5006	142	22	PDF	IES	5042	143	22	PDF	IES	5171	147	23	PDF	IES	4982	142	22	PDF	IES						
	4500	32	4447	141	22	PDF	IES	4520	143	22	PDF	IES	4553	144	22	PDF	IES	4667	148	22	PDF	IES	4501	143	22	PDF	IES						
	4000	28	3969	142	22	PDF	IES	4014	143	22	PDF	IES	4055	144	22	PDF	IES	4163	149	22	PDF	IES	4010	144	22	PDF	IES						
	3500	24	3476	143	21	PDF	IES	3496	143	21	PDF	IES	3551	145	21	PDF	IES	3654	150	21	PDF	IES	3510	144	21	PDF	IES						
	3000	21	2979	143	21	PDF	IES	2982	143	21	PDF	IES	3048	146	21	PDF	IES	3145	151	21	PDF	IES	3011	145	21	PDF	IES						
	2500	17	2470	144	20	PDF	IES	2467	143	20	PDF	IES	2533	147	20	PDF	IES	2620	152	20	PDF	IES	2501	146	20	PDF	IES						
	2000	14	1961	143	19	PDF	IES	1965	142	19	PDF	IES	2015	146	19	PDF	IES	2084	152	19	PDF	IES	1990	145	19	PDF	IES						
Tunable White	5000	44	5001	112	22	PDF	IES	5001	112	22	PDF	IES	5001	113	22	PDF	IES	5001	113	22	PDF	IES	5001	114	22	PDF	IES	5001	115	22	PDF	IES	
	4500	39	4502	115	22	PDF	IES	4502	115	22	PDF	IES	4502	115	22	PDF	IES	4502	116	22	PDF	IES	4502	116	22	PDF	IES	4502	117	22	PDF	IES	
	4000	34	3999	117	22	PDF	IES	3999	117	22	PDF	IES	3999	118	22	PDF	IES	3999	118	22	PDF	IES	3999	119	22	PDF	IES	3999	119	22	PDF	IES	
	3500	29	3499	119	21	PDF	IES	3499	120	21	PDF	IES	3499	120	21	PDF	IES	3499	120	21	PDF	IES	3499	121	21	PDF	IES	3499	121	21	PDF	IES	
	3000	24	3001	122	21	PDF	IES	3001	122	21	PDF	IES	3001	122	21	PDF	IES	3001	123	21	PDF	IES	3001	123	21	PDF	IES	3001	123	21	PDF	IES	
	2500	20	2503	124	20	PDF	IES	2503	124	20	PDF	IES	2503	124	20	PDF	IES	2503	124	20	PDF	IES	2503	125	20	PDF	IES	2503	125	20	PDF	IES	
	2000	16	2001	125	19	PDF	IES	2001	125	19	PDF	IES	2001	125	19	PDF	IES	2001	125	19	PDF	IES	2001	126	19	PDF	IES	2001	126	19	PDF	IES	

ArcForm Duo 2'x2' MesoOptics (Batwing)

Click "PDF" or "IES" text to download

Nominal CRI & CCT		CRI 90+, 2700K					CRI 90+, 3000K					CRI 90+, 3500K					CRI 90+, 4000K					CRI 90+, 5000K					CRI 90+, 6500K						
Lumen Package	Watts (W)	Flux (lm) ¹	Efficacy (LPW) ¹	UGR ²	Photometry Report	IES File	Flux (lm) ¹	Efficacy (LPW) ¹	UGR ²	Photometry Report	IES File	Flux (lm) ¹	Efficacy (LPW) ¹	UGR ²	Photometry Report	IES File	Flux (lm) ¹	Efficacy (LPW) ¹	UGR ²	Photometry Report	IES File	Flux (lm) ¹	Efficacy (LPW) ¹	UGR ²	Photometry Report	IES File	Flux (lm) ¹	Efficacy (LPW) ¹	UGR ²	Photometry Report	IES File		
Static White	5000	36	4857	135	20	PDF	IES	4964	137	20	PDF	IES	5003	138	20	PDF	IES	5132	142	20	PDF	IES	4943	137	20	PDF	IES						
	4500	32	4410	137	19	PDF	IES	4488	139	19	PDF	IES	4519	140	19	PDF	IES	4632	143	20	PDF	IES	4467	139	19	PDF	IES						
	4000	29	3940	137	19	PDF	IES	3989	139	19	PDF	IES	4026	140	19	PDF	IES	4132	144	19	PDF	IES	3981	139	19	PDF	IES						
	3500	25	3459	138	19	PDF	IES	3483	138	19	PDF	IES	3533	140	19	PDF	IES	3633	145	19	PDF	IES	3493	140	19	PDF	IES						
	3000	21	2961	138	18	PDF	IES	2965	138	18	PDF	IES	3028	141	18	PDF	IES	3123	146	18	PDF	IES	2991	140	18	PDF	IES						
	2500	18	2455	140	17	PDF	IES	2452	139	17	PDF	IES	2517	142	17	PDF	IES	2603	148	18	PDF	IES	2486	141	17	PDF	IES						
	2000	14	1949	138	17	PDF	IES	1952	138	17	PDF	IES	2003	142	17	PDF	IES	2072	147	17	PDF	IES	1978	141	17	PDF	IES						
Tunable White	5000	46	5002	107	20	PDF	IES	5002	108	20	PDF	IES	5002	108	20	PDF	IES	5002	109	20	PDF	IES	5002	110	20	PDF	IES	5002	111	20	PDF	IES	
	4500	40	4499	110	19	PDF	IES	4499	111	19	PDF	IES	4499	111	19	PDF	IES	4499	111	19	PDF	IES	4499	112	19	PDF	IES	4499	113	19	PDF	IES	
	4000	35	3999	113	19	PDF	IES	3999	113	19	PDF	IES	3999	113	19	PDF	IES	3999	114	19	PDF	IES	3999	114	19	PDF	IES	3999	115	19	PDF	IES	
	3500	30	3500	115	19	PDF	IES	3500	116	19	PDF	IES	3500	116	19	PDF	IES	3500	116	19	PDF	IES	3500	117	19	PDF	IES	3500	117	19	PDF	IES	
	3000	25	3003	117	18	PDF	IES	3003	118	18	PDF	IES	3003	118	18	PDF	IES	3003	118	18	PDF	IES	3003	119	18	PDF	IES	3003	119	18	PDF	IES	
	2500	21	2501	120	17	PDF	IES	2501	120	17	PDF	IES	2501	120	17	PDF	IES	2501	120	17	PDF	IES	2501	121	17	PDF	IES	2501	121	17	PDF	IES	
	2000	16	2000	121	17	PDF	IES	2000	121	17	PDF	IES	2000	121	17	PDF	IES	2000	121	17	PDF	IES	2000	122	17	PDF	IES	2000	122	17	PDF	IES	

- Luminaire photometry has been conducted in accordance with IES LM-79-08. IES files can be downloaded by clicking the links in the table above, or online at ledalite.com.
- Unified Glare Rating (UGR) is calculated in accordance with CIE 117-1995. Reference conditions of 4Hx8Hx1H and reflectances of 70/50/20% have been applied using the procedure described in CIE 190-2010.
- For Tunable White, all IES files use 2700K data. Photometry Reports reflect the appropriate performance at the nominal CCT chosen.

Silk (Lambertian)

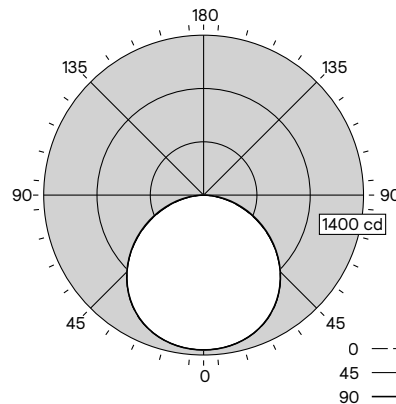

100% Down / 0% Up

MesoOptics (Batwing)

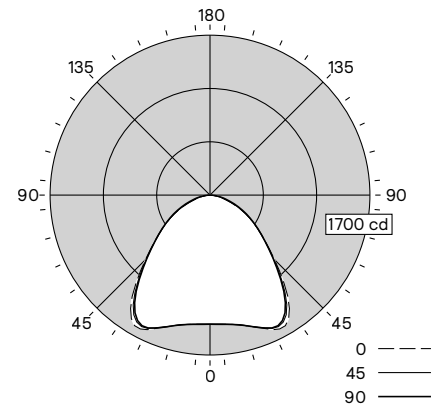

100% Down / 0% Up

ArcForm Duo Architectural Recessed

Photometry

ArcForm Duo 2'x4' Silk (Lambertian)

Click "PDF" or "IES" text to download

Nominal CRI & CCT		CRI 90+, 2700K					CRI 90+, 3000K					CRI 90+, 3500K					CRI 90+, 4000K					CRI 90+, 5000K					CRI 90+, 6500K							
Lumen Package	Watts (W)	Flux (lm)	Efficacy (LPW)	UGR ²	Photometry Report	IES File	Flux (lm)	Efficacy (LPW)	UGR ²	Photometry Report	IES File	Flux (lm)	Efficacy (LPW)	UGR ²	Photometry Report	IES File	Flux (lm)	Efficacy (LPW)	UGR ²	Photometry Report	IES File	Flux (lm)	Efficacy (LPW)	UGR ²	Photometry Report	IES File	Flux (lm)	Efficacy (LPW)	UGR ²	Photometry Report	IES File			
Static White	8000	59	7705	129	21	PDF IES	7842	133	21	PDF IES	7925	134	21	PDF IES	8117	137	21	PDF IES	8200	139	21	PDF IES												
	7500	55	7252	130	21	PDF IES	7392	134	21	PDF IES	7466	135	21	PDF IES	7655	138	21	PDF IES	7723	140	21	PDF IES												
	7000	52	6805	130	21	PDF IES	6946	133	21	PDF IES	7009	134	21	PDF IES	7195	138	21	PDF IES	7239	139	21	PDF IES												
	6500	48	6349	132	20	PDF IES	6490	136	20	PDF IES	6542	136	20	PDF IES	6723	140	21	PDF IES	6735	141	21	PDF IES												
	6000	44	5889	134	20	PDF IES	6026	138	20	PDF IES	6068	138	20	PDF IES	6241	143	20	PDF IES	6219	142	20	PDF IES												
	5500	40	5422	135	20	PDF IES	5552	139	20	PDF IES	5585	140	20	PDF IES	5747	144	20	PDF IES	5692	143	20	PDF IES												
	5000	36	4952	138	20	PDF IES	5071	142	20	PDF IES	5098	142	20	PDF IES	5245	147	20	PDF IES	5162	145	20	PDF IES												
	4500	32	4464	140	19	PDF IES	4569	143	19	PDF IES	4594	144	19	PDF IES	4719	148	19	PDF IES	4618	146	19	PDF IES												
Tunable White	4000	28	3957	140	19	PDF IES	4041	144	19	PDF IES	4070	145	19	PDF IES	4166	149	19	PDF IES	4060	145	19	PDF IES												
	5000	40	5003	123	20	PDF IES	5003	124	20	PDF IES	5003	125	20	PDF IES	5003	125	20	PDF IES	5003	126	20	PDF IES	5003	128	20	PDF IES	5003	128	20	PDF IES	5003	128	20	PDF IES
	4500	35	4501	126	19	PDF IES	4501	126	19	PDF IES	4501	127	19	PDF IES	4501	127	19	PDF IES	4501	128	19	PDF IES	4501	128	19	PDF IES	4501	129	19	PDF IES	4501	129	19	PDF IES
	4000	31	3996	129	19	PDF IES	3996	129	19	PDF IES	3996	129	19	PDF IES	3996	129	19	PDF IES	3996	129	19	PDF IES	3996	130	19	PDF IES	3996	130	19	PDF IES	3996	130	19	PDF IES

ArcForm Duo 2'x4' MesoOptics (Batwing)

Click "PDF" or "IES" text to download

Nominal CRI & CCT		CRI 90+, 2700K					CRI 90+, 3000K					CRI 90+, 3500K					CRI 90+, 4000K					CRI 90+, 5000K					CRI 90+, 6500K							
Lumen Package	Watts (W)	Flux (lm)	Efficacy (LPW)	UGR ²	Photometry Report	IES File	Flux (lm)	Efficacy (LPW)	UGR ²	Photometry Report	IES File	Flux (lm)	Efficacy (LPW)	UGR ²	Photometry Report	IES File	Flux (lm)	Efficacy (LPW)	UGR ²	Photometry Report	IES File	Flux (lm)	Efficacy (LPW)	UGR ²	Photometry Report	IES File	Flux (lm)	Efficacy (LPW)	UGR ²	Photometry Report	IES File			
Static White	8000	59	7849	132	19	PDF IES	7989	135	19	PDF IES	8073	136	19	PDF IES	8268	139	19	PDF IES	8353	141	19	PDF IES												
	7500	55	7382	133	18	PDF IES	7525	136	18	PDF IES	7600	137	18	PDF IES	7793	141	19	PDF IES	7862	142	19	PDF IES												
	7000	52	6921	132	18	PDF IES	7065	136	18	PDF IES	7129	137	18	PDF IES	7319	141	18	PDF IES	7362	142	18	PDF IES												
	6500	48	6452	134	18	PDF IES	6595	138	18	PDF IES	6647	139	18	PDF IES	6831	143	18	PDF IES	6842	143	18	PDF IES												
	6000	44	5977	136	18	PDF IES	6116	140	18	PDF IES	6158	141	18	PDF IES	6334	145	18	PDF IES	6310	145	18	PDF IES												
	5500	40	5495	138	17	PDF IES	5627	142	17	PDF IES	5660	143	17	PDF IES	5825	148	18	PDF IES	5767	146	18	PDF IES												
	5000	35	5010	141	17	PDF IES	5130	145	17	PDF IES	5158	145	17	PDF IES	5305	150	17	PDF IES	5220	148	17	PDF IES												
	4500	32	4506	142	17	PDF IES	4611	146	17	PDF IES	4637	147	17	PDF IES	4762	151	17	PDF IES	4658	148	17	PDF IES												
Tunable White	4000	28	3989	143	16	PDF IES	4072	147	16	PDF IES	4102	148	16	PDF IES	4197	152	16	PDF IES	4089	148	16	PDF IES												
	5000	39	5003	126	17	PDF IES	5003	127	17	PDF IES	5003	127	17	PDF IES	5003	128	17	PDF IES	5003	129	17	PDF IES	5003	130	17	PDF IES	5003	130	17	PDF IES	5003	130	17	PDF IES
	4500	35	4498	129	17	PDF IES	4498	129	17	PDF IES	4498	130	17	PDF IES	4498	130	17	PDF IES	4498	131	17	PDF IES	4498	131	17	PDF IES	4498	131	17	PDF IES	4498	131	17	PDF IES
	4000	30	3994	131	16	PDF IES	3994	131	16	PDF IES	3994	131	16	PDF IES	3994	132	16	PDF IES	3994	132	16	PDF IES	3994	132	16	PDF IES	3994	132	16	PDF IES	3994	132	16	PDF IES

- Luminaire photometry has been conducted in accordance with IES LM-79-08. IES files can be downloaded by clicking the links in the table above, or online at ledalite.com.
- Unified Glare Rating (UGR) is calculated in accordance with CIE 117-1995. Reference conditions of 4Hx8Hx1H and reflectances of 70/50/20% have been applied using the procedure described in CIE 190-2010.
- For Tunable White, all IES files use 2700K data. Photometry Reports reflect the appropriate performance at the nominal CCT chosen.

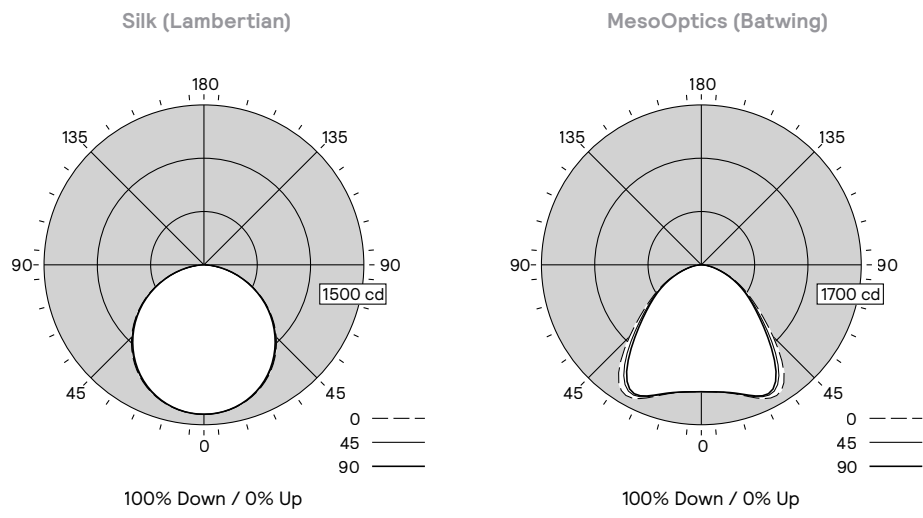

ArcForm Duo Architectural Recessed

Photometry

ArcForm Duo 1'x4' Silk (Lambertian)

Click "PDF" or "IES" text to download

Nominal CRI & CCT		CRI 90+, 2700K					CRI 90+, 3000K					CRI 90+, 3500K					CRI 90+, 4000K					CRI 90+, 5000K					CRI 90+, 6500K											
Lumen Package	Watts (W)	Flux (lm)	Efficacy (LPW)	UGR ²	Photometry Report	IES File	Flux (lm)	Efficacy (LPW)	UGR ²	Photometry Report	IES File	Flux (lm)	Efficacy (LPW)	UGR ²	Photometry Report	IES File	Flux (lm)	Efficacy (LPW)	UGR ²	Photometry Report	IES File	Flux (lm)	Efficacy (LPW)	UGR ²	Photometry Report	IES File	Flux (lm)	Efficacy (LPW)	UGR ²	Photometry Report	IES File							
Static White	5000	37	4774	129	22	PDF IES	4953	133	22	PDF IES	5078	136	22	PDF IES	5122	137	22	PDF IES	4979	135	22	PDF IES																
	4500	33	4341	131	22	PDF IES	4494	135	22	PDF IES	4582	138	22	PDF IES	4624	139	22	PDF IES	4497	136	22	PDF IES																
	4000	30	3890	132	21	PDF IES	4015	136	21	PDF IES	4076	138	22	PDF IES	4121	140	22	PDF IES	4006	137	21	PDF IES																
	3500	26	3423	133	21	PDF IES	3520	137	21	PDF IES	3563	138	21	PDF IES	3613	141	21	PDF IES	3507	137	21	PDF IES																
	3000	22	2942	134	20	PDF IES	3014	138	20	PDF IES	3045	138	21	PDF IES	3099	142	21	PDF IES	3002	138	20	PDF IES																
	2500	18	2447	136	20	PDF IES	2500	139	20	PDF IES	2525	140	20	PDF IES	2578	143	20	PDF IES	2492	139	20	PDF IES																
	2000	14	1940	136	19	PDF IES	1983	139	19	PDF IES	2006	139	19	PDF IES	2048	142	19	PDF IES	1980	139	19	PDF IES																
Tunable White	5000	45	5008	110	22	PDF IES	5008	110	22	PDF IES	5008	111	22	PDF IES	5008	111	22	PDF IES	5008	112	22	PDF IES	5008	113	22	PDF IES	5008	113	22	PDF IES	5008	113	22	PDF IES				
	4500	39	4489	115	22	PDF IES	4489	115	22	PDF IES	4489	115	22	PDF IES	4489	115	22	PDF IES	4489	115	22	PDF IES	4489	115	22	PDF IES	4489	115	22	PDF IES	4489	115	22	PDF IES	4489	115	22	PDF IES
	4000	34	3991	117	21	PDF IES	3991	117	21	PDF IES	3991	117	21	PDF IES	3991	117	21	PDF IES	3991	117	21	PDF IES	3991	117	21	PDF IES	3991	117	21	PDF IES	3991	117	21	PDF IES	3991	117	21	PDF IES
	3500	29	3503	119	21	PDF IES	3503	119	21	PDF IES	3503	119	21	PDF IES	3503	119	21	PDF IES	3503	119	21	PDF IES	3503	119	21	PDF IES	3503	119	21	PDF IES	3503	119	21	PDF IES	3503	119	21	PDF IES
	3000	25	3012	120	20	PDF IES	3012	121	20	PDF IES	3012	121	20	PDF IES	3012	121	20	PDF IES	3012	121	20	PDF IES	3012	122	20	PDF IES	3012	122	20	PDF IES	3012	122	20	PDF IES	3012	122	20	PDF IES
	2500	20	2505	122	20	PDF IES	2505	123	20	PDF IES	2505	123	20	PDF IES	2505	123	20	PDF IES	2505	123	20	PDF IES	2505	123	20	PDF IES	2505	123	20	PDF IES	2505	123	20	PDF IES	2505	123	20	PDF IES
	2000	16	1992	125	19	PDF IES	1992	124	19	PDF IES	1992	124	19	PDF IES	1992	124	19	PDF IES	1992	124	19	PDF IES	1992	124	19	PDF IES	1992	124	19	PDF IES	1992	123	19	PDF IES	1992	123	19	PDF IES

ArcForm Duo 1'x4' MesoOptics (Batwing)

Click "PDF" or "IES" text to download

Nominal CRI & CCT		CRI 90+, 2700K					CRI 90+, 3000K					CRI 90+, 3500K					CRI 90+, 4000K					CRI 90+, 5000K					CRI 90+, 6500K											
Lumen Package	Watts (W)	Flux (lm)	Efficacy (LPW)	UGR ²	Photometry Report	IES File	Flux (lm)	Efficacy (LPW)	UGR ²	Photometry Report	IES File	Flux (lm)	Efficacy (LPW)	UGR ²	Photometry Report	IES File	Flux (lm)	Efficacy (LPW)	UGR ²	Photometry Report	IES File	Flux (lm)	Efficacy (LPW)	UGR ²	Photometry Report	IES File	Flux (lm)	Efficacy (LPW)	UGR ²	Photometry Report	IES File							
Static White	5000	37	4761	128	20	PDF IES	4939	133	20	PDF IES	5063	136	20	PDF IES	5108	137	20	PDF IES	4965	134	20	PDF IES																
	4500	33	4329	131	20	PDF IES	4481	135	20	PDF IES	4569	137	20	PDF IES	4611	139	20	PDF IES	4484	136	20	PDF IES																
	4000	30	3879	132	19	PDF IES	4003	136	19	PDF IES	4065	138	19	PDF IES	4109	139	19	PDF IES	3994	136	19	PDF IES																
	3500	26	3414	133	19	PDF IES	3510	137	19	PDF IES	3553	138	19	PDF IES	3603	140	19	PDF IES	3497	137	19	PDF IES																
	3000	22	2934	134	18	PDF IES	3005	137	18	PDF IES	3037	138	18	PDF IES	3091	141	18	PDF IES	2993	137	18	PDF IES																
	2500	18	2440	136	18	PDF IES	2493	139	18	PDF IES	2518	139	18	PDF IES	2571	143	18	PDF IES	2485	139	18	PDF IES																
	2000	14	1935	135	17	PDF IES	1978	138	17	PDF IES	2000	139	17	PDF IES	2043	142	17	PDF IES	1974	138	17	PDF IES																
Tunable White	5000	45	5007	109	20	PDF IES	5007	110	20	PDF IES	5007	111	20	PDF IES	5007	111	20	PDF IES	5007	112	20	PDF IES	5007	113	20	PDF IES	5007	113	20	PDF IES	5007	113	20	PDF IES				
	4500	39	4488	114	20	PDF IES	4488	114	20	PDF IES	4488	114	20	PDF IES	4488	114	20	PDF IES	4488	115	20	PDF IES	4488	115	20	PDF IES	4488	115	20	PDF IES	4488	115	20	PDF IES	4488	115	20	PDF IES
	4000	34	3990	117	19	PDF IES	3990	117	19	PDF IES	3990	117	19	PDF IES	3990	117	19	PDF IES	3990	117	19	PDF IES	3990	117	19	PDF IES	3990	117	19	PDF IES	3990	117	19	PDF IES	3990	117	19	PDF IES
	3500	29	3504	118	19	PDF IES	3504	119	19	PDF IES	3504	119	19	PDF IES	3504	119	19	PDF IES	3504	119	19	PDF IES	3504	119	19	PDF IES	3504	119	19	PDF IES	3504	119	19	PDF IES	3504	119	19	PDF IES
	3000	25	3009	120	18	PDF IES	3009	120	18	PDF IES	3009	121	18	PDF IES	3009	121	18	PDF IES	3009	121	18	PDF IES	3009	121	18	PDF IES	3009	121	18	PDF IES	3009	122	18	PDF IES	3009	122	18	PDF IES
	2500	20	2504	122	18	PDF IES	2504	122	18	PDF IES	2504	122	18	PDF IES	2504	122	18	PDF IES	2504	123	18	PDF IES	2504	123	18	PDF IES	2504	123	18	PDF IES	2504	123	18	PDF IES	2504	123	18	PDF IES
	2000	16	1992	125	17	PDF IES	1992	124	17	PDF IES	1992	124	17	PDF IES	1992	124	17	PDF IES	1992	123	17	PDF IES	1992	123	17	PDF IES	1992	123	17	PDF IES	1992	123	17	PDF IES	1992	123	17	PDF IES

- Luminaire photometry has been conducted in accordance with IES LM-79-08. IES files can be downloaded by clicking the links in the table above, or online at ledalite.com.
- Unified Glare Rating (UGR) is calculated in accordance with CIE 117-1995. Reference conditions of 4Hx8Hx1H and reflectances of 70/50/20% have been applied using the procedure described in CIE 190-2010.
- For Tunable White, all IES files use 2700K data. Photometry Reports reflect the appropriate performance at the nominal CCT chosen.

