

INSTALLATION

CHLORIDE

by  Signify

WARNINGS AND INSTRUCTIONS FOR LUMINAIRES

IMPORTANT: FOR YOUR PROTECTION, YOU MUST CAREFULLY READ ALL WARNINGS AND INSTRUCTIONS IN THEIR ENTIRETY PRIOR TO INSTALLATION, OPERATION, SERVICE, OR MAINTENANCE. FAILURE TO DO SO CAN RESULT IN DEATH, PERSONAL INJURY AND PROPERTY DAMAGE. If you do not understand these warnings and instructions, or if additional information is desired, please contact the Customer Care Call Center at 800-555-0050.

- **Installation, service, and maintenance of luminaires must be performed by a qualified professional and in accordance with all federal, state, and local laws, regulations, and electrical codes. This professional should be familiar with the construction and operation of this product and any hazards involved. If not qualified, do not attempt installation, service or maintenance.**
- **To reduce the risk of death, personal injury or property damage from fire, electric shock, falling parts, cuts, abrasions, and other hazards, please read all warnings and instructions included with the luminaire, on the luminaire's packaging and affixed to the luminaire itself.**
- **Maintenance of the luminaires should be performed by person(s) familiar with the luminaire's construction and operation and any hazards involved.**
- **Use caution when servicing batteries. Battery acid can cause burns to skin and eyes. If acid is spilled on skin or eyer, flush acid with fresh water and contact a physician immediately.**

 **WARNING**
RISK OF FIRE, ELECTRIC SHOCK OR PERSONAL INJURY

- Disconnect or turn off power before attempting any installation, service or maintenance.
- Verify that supply voltage is correct by referencing the luminaire label information.
- Make all electrical and ground connections in accordance with the National Electrical Code (NEC) and any other applicable laws, regulations, or codes.
- All wiring connections should be capped with UL-approved wire connectors.

 **WARNING**
RISK OF PERSONAL INJURY

- Keep combustible materials away from LED/lamp & lens.
- Do not operate in close proximity to persons, combustible materials or substances affected by heat or drying.

 **WARNING**
RISK OF PERSONAL INJURY

- Wear gloves and safety glasses at all times when removing luminaire from carton, installing, servicing or performing maintenance.
- Avoid direct eye exposure to the light source while it is on.

 **WARNING**
RISK OF FIRE, ELECTRIC SHOCK OR PERSONAL INJURY

- Allow LED/lamp & lens to cool before handling.
- Do not touch enclosure or light source.
- Do not exceed maximum wattage marked on luminaire label.
- Follow all manufacturer's warnings, recommendations, instructions, and restrictions for driver type, burning position, mounting locations and replacement.



CAUTION

RISK OF PRODUCT DAMAGE

- Never connect luminaires and/or components under load with supply voltage turned on.
- Do not mount or support these luminaires in a manner that can cut the outer jacket or damage wire insulation.
- Do not restrict fixture ventilation. Allow for some volume of airspace around the luminaire. Avoid covering the luminaire with insulation, foam, or other material that will prevent convection or conduction cooling.
- Do not exceed luminaire maximum ambient temperature.
- Do not modify the luminaire.
- Only use luminaire in its intended application and location.
- LED products are polarity sensitive. Ensure proper polarity before installation.
- Electrostatic Discharge (ESD) can damage LED. Personal grounding equipment must be worn during all installation and servicing of the luminaire.
- Do not touch individual electrical components as this can cause ESD, shorten LED life, or impact LED performance. Some components inside the luminaire may not be serviceable. In the unlikely event, your luminaire may require service, stop using it immediately and contact the Customer Care Call Center at 800-555-0050.
- Always read the luminaire's complete installation instructions prior to installation for any additional luminaire- specific warnings.
- In the case of HID or Fluorescent luminaires, regular re-lamping is required to keep the luminaire operating within safe limits.

- **Do not install damaged products.** Handling and installing damaged products can potentially increase the risks mentioned. In case of damage and/or missing parts upon arrival of the luminaire, please contact the Customer Care Call Center at 800-555-0050.
- These instructions do not purport to cover all details or variations in equipment nor to provide every possible contingency to meet in connection with installation, operation, or maintenance. Should further information be desired, or should particular problems arise which are not covered sufficiently for the purchaser's or owner's purposes, this matter should be referred to the Customer Care Call Center at 800-555-0050.
- Please see luminaire-specific Installation and Maintenance Instruction for additional warnings or any applicable FCC or regulatory statements. Failure to follow any of these instructions could void luminaire warranties.

Luminaire Maintenance

- Regular luminaire maintenance programs are recommended.
- It is recommended to clean the outside of the luminaire and the refractor/lens.
- Frequency of cleaning will depend on ambient dirt level and minimum light output which is acceptable to the user.
- If clean water is not sufficient for cleaning, use a neutral, synthetic, non-scratching, and non-abrasive cleaning substance.
- Never use alkaline and/or acetous cleaning substances.
- Make sure that the cleaning substance is carefully removed by rinsing with lots of clean water.
- Signify recommends using a cleaning solution that has a PH between 5 and 8.
- Recycle: For information on how to recycle electronic products and components, please visit www.epa.gov.

Note: This equipment has been tested and found to comply with the limits for a Class B digital device, pursuant to part 15 of the FCC Rules. These limits are designed to provide reasonable protection against harmful interference in a residential installation. This equipment generates, uses, and can radiate radio frequency energy and, if not installed and used in accordance with the instructions, may cause harmful interference to radio communications. However, there is no guarantee that interference will not occur in a particular installation. If this equipment does cause harmful interference to radio or television reception, which can be determined by turning the equipment off and on, the user is encouraged to try to correct the interference by one or more of the following measures:

- Reorient or relocate the receiving antenna.
- Increase the separation between the equipment and receiver.
- Connect the equipment into an outlet on a circuit different from that to which the receiver is connected.
- Consult the dealer or an experienced radio/TV technician for help.

INSTALLATION INSTRUCTIONS

WET LOCATION EMERGENCY LIGHTING FIXTURE

'MR-16' TYPE LAMP HEADS

READ AND FOLLOW ALL SAFETY INSTRUCTIONS

CAUTION: The battery in this unit may not be fully charged. After electricity is connected to unit, let battery charge for at least 24 hours, then normal operation of this unit should take effect. To check, press the TEST button. The lamps on the unit should turn on.

IMPORTANT SAFEGUARDS: When using electrical equipment, basic safety precautions should always be followed, including the following:

1. Consult local building code for approved wiring and installation.
2. Disconnect AC power before servicing and installation.
3. Do not mount near gas or electric heaters.
4. Do not use outdoors.
5. Do not use this equipment for anything other than its intended use.
6. The use of accessory equipment not recommended by the manufacturer will void product listing and warranty and may cause an unsafe condition.
7. Any service on this equipment should be performed by qualified personnel only.
8. Equipment should be mounted in locations and at heights where it will not be subject to tampering by unauthorized personnel.
9. Use caution when servicing batteries.
10. Cap unused wires with enclosed wire nuts or other approved method.
11. Make sure wire terminations are secure, and leads are properly tucked in appropriate wire channels

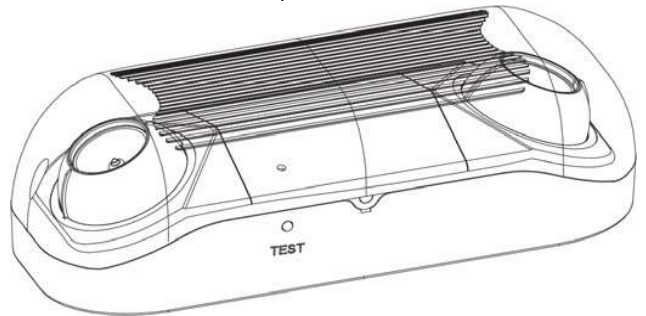

INSTALLATION (J-BOX MOUNTING):

1. Feed fixture leads through back plate and connect AC power supply (Fig. A).
2. Connect wires through J-Box. Mount back plate on J-Box and secure with screws.
3. Connect battery only after continuous AC power can be provided to the unit (Fig. B).
4. Align snaps and push housing directly onto main bottom case (Fig. C). Apply continuous AC power. For 120V supply connect line wire to Black lead; for 277V supply connect line wire to Red lead. Connect neutral wire to White lead. Press "TEST" button to check for proper operation of the unit.

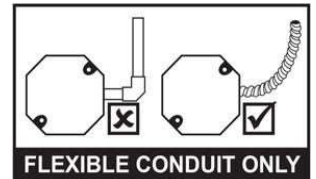

INSTALLATION (CONDUIT):

1. Secure back plate to wall surface. Route wires through hole in conduit flange and make conduit connection.
2. Connect battery only after continuous AC power can be provided to the unit (Fig. B).
3. Align snaps and push housing directly onto back plate (Fig. C). For 120V supply connect line wire to Black lead; for 277V supply connect line wire to Red lead. Connect neutral wire to White lead. Press "TEST" button to check for proper operation of the unit.

CAUTION: A torque of 7.5 lbf-in is recommended to secure the lens to the housing, using the screws.

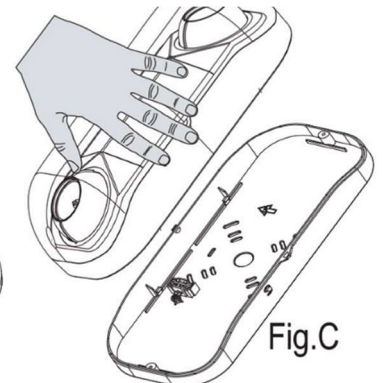
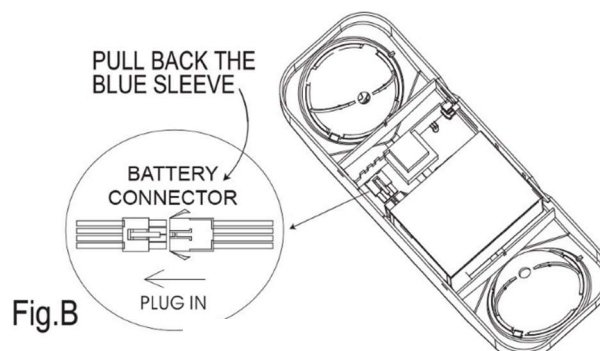
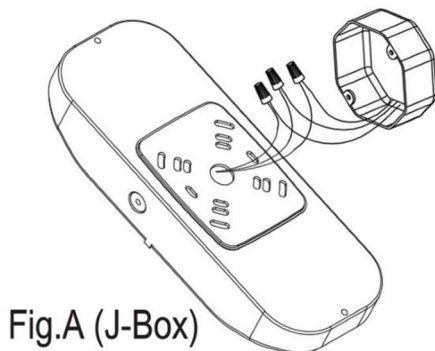

TROUBLE - SHOOTING:

Condition - The emergency lights do not operate

1. If the charge indicator light is off: Check that the circuit breaker for AC supply is ON.
2. If the charge indicator light is ON: Check that battery is properly connected. If problem persists, Replace battery.

If the local lamps don't turn ON after disconnecting the remote circuit wires, then replace the battery.

Condition - Emergency lights are dim

1. Battery not fully charged. Allow battery to recharge for 24 hours and then retest. If the lights are still dim, replace battery.

OPERATION:

1. Apply AC power to the unit. The LED Indicator should turn RED.
2. After the battery has been left to charge for 2 hours, test the unit by pushing the switch. The LED indicator turns OFF and the lamps on the unit turn ON.
3. When the switch is released, the lamps turn OFF and the LED indicator turns back to RED.

TESTING:

National Electric Code (NEC) and NFPA life safety code regulations require that routine tests need to be performed as listed below: Once every month, the unit needs to be tested for duration of 30 seconds. Push in and hold the test switch to perform this test. Once every 12 months, a full 90-minute (per UL requirements) test needs to be performed on the unit. Disconnect power to the unit and leave it in emergency mode. The lamps should stay ON for at least 90 minutes.

MAINTENANCE:

Caution: Always turn off AC power to the equipment before servicing. Servicing should be performed only by a qualified service technician. Use only MANUFACTURER supplied replacement parts.

1. BATTERY: The battery supplied in this equipment requires no maintenance. However, it should be tested periodically (see TESTING) and replaced when it no longer operates the connected fixtures for the duration of a 30-second or 90-minute test. The battery supplied in this equipment has a life expectancy of 5-7 years when used in a normal ambient temperature of 72°F.
2. OTHER: Clean lenses and replace lamps, as and when required.

WIRING DIAGRAMS:

