



Calculite LED 4" generation 3 provides an excellent coupling of lighting performance, quality of light, and visual aesthetic. Industry leading visual comfort and uniform illumination make it an ideal choice for office, institution, healthcare, public, and retail applications.

Standard luminaire: Order without BAC option code.
Buy American Act of 1933 (BAA)* Compliant luminaire: Order with BAC option code.

Project: _____
 Location: _____
 Cat.No: _____
 Type: _____
 Lamps: _____ Qty: _____
 Notes: _____

Fixture

standard example: C4SDL15935MZ10UCCW | BAC example: C4SDL15935MZ10UCCW-BAC

Series	Mounts	Styles	Lums	CRI/CCT	Beams	Dimming	Dim opts	Voltage	Reflector finish	Cylinder finish	Buy American
C4											
C4 Calculite LED 4"	S Surface	DL Downlight	05 500	927 90CRI/2700K 930 90CRI/3000K	N Narrow ⁴	Z10 0-10V 1%	D2O Dim to Off	U 120V/277V 3 347V (Z10 only)	CL Specular clear CC Comfort clear CD Comfort clear diffuse CZ Champagne bronze BK Black (matte)	W White (matte) B Black (matte) A Aluminum RAL RAL Color ⁷ (standard code)	BAC Meets the conditions of the Buy American Act of 1933 (BAA)*
		WW Wall Wash ²	10 1000	935 90CRI/3500K 940 90CRI/4000K	M Medium ⁴						
	P Pendant ¹	DW Double Wall Wash ²	15 1500	950 90CRI/5000K ³ D2W 90CRI/3000K to 1800K ⁴ (dim-to-warm)	W Wide ²	L1 Lutron LDE1 EcoSystem (500lm not available)	U 120V/277V				
			20 2000			D DALI 0.1% ⁵	LIN Linear	U 120V/277V			
			25 2500			DMX Digital Multiplexing w/RDM 0.1% ^{5,6}	LIN Linear	U 120V/277V			
			30 3000			SOL 0-10V 0.1% ⁵	SQR Square				
						E Forward & Reverse Phase (up to 2500lm)		1 120V			
						RA Integral Interact-enabled RF sensor ⁵ (enables wireless connected lighting control)		U 120V/277V			

Pendant accessories (field adjustable)¹ example: CASK36BK

Series	Mounts	Length	Finish	Options
CA				
CA Calculite Accessory	SK Stem Kit	36 36 inches	WH White (matte)	- None
		48 48 inches	BK Black (matte)	X DMX dimming only
60 60 inches		AL Aluminum		
72 72 inches		RAL RAL Color ⁶ (standard code)		
	CK Cable Kit ⁵ (RAL canopy kit will be with black cord)	10 120 inches	(same four color options as above)	- None

Accessories (not currently BAA-compliant)

SBA Interact Ready System Bridge Accessory
 (refer to Philips System Bridge Accessory spec sheet for options and details
 Requires IRT9015 IR remote & Interact Pro App for commissioning)

- Pendant (P) option needs to be ordered with an accessory.
 - Wall Wash (WW) and Double Wall Wash (DW) are only available with Wide (W) beam.
 - Consult factory for 5000K CCT (50) with narrow (N) beam.
 - Dim-to-warm (D2W) available only with Z10 dimming up to 2000lm. Narrow (N) and medium (M) beams only. Remote driver configuration.
 - Requires external mount driver available only for surface (S) and pendant (P) mounts. See dimensions on page 3 and details on page 2.
 - Digital Multiplex (DMX) dimming is not compatible with the Cable Kit (CK) accessory.
 - RAL standard colors can be specified upon request. Add RAL standard code to (RALxxxxx).
- * Failure to properly select the "BAC" suffix could result in you receiving product that is not BAA compliant product with no recourse for an RMA or refund. This BAC designation hereunder does not address (i) the applicability of, or availability of a waiver under, the Trade Agreements Act, or (ii) the "Buy America" domestic content requirements imposed on states, localities, and other non-federal entities as a condition of receiving funds administered by the Department of Transportation or other federal agencies.

C4 Calculite LED 4" gen 3

Cylinder

Cylinder

Cylinder housing: Cast aluminum, available for installation onto a 3" or 4" junction box, stem, cable, or wall mounted.

Surface mounting (C4S): Mounts directly to junction box. Listed for wet location use.

Pendant mounting (C4P): Order with the stem or cable kit. Listed for damp location use.

Wall Mounting (C4W): Pre-attached hardware allows for simple installation into wall mounted junction box. Listed for damp location use.

Pendant accessories (damp location rated)

Stem mounting kit: 0.375" diameter steel stem (1/8" National Pipe Thread, can be field cut to required length. 5-wire conductor cable runs alongside of stem for power and dimming. Magnetic attachment of canopy to junction box provides clean look free of hardware. Self-aligning swivel mounting system ensures cylinder hangs straight down. Stem can be cut in field for length adjustment. A 1/8" hole is required to reconnect the pendant stem to the canopy swivel. Swivel accommodates max 45° pitch.

Cable mounting kit: 10' long steel cable with 5-wire cable for power and dimming. Hardware free canopy for clean aesthetics.

Remote drivers

- Available with surface and pendant mounts only
- Requires new construction or accessibility from above for initial installation
- Mains/control wiring in frame junction box
- Connection to light engine in secondary junction box
- Remote driver is accessible from below upon removal of the cylinder

Dimming drivers

All configurations are FCC Class A unless otherwise specified.

- Advance 0-10V 1% (Z10), logarithmic curve is standard, specify D20 for factory-set dim-to-off function, consult factory for linear dimming curve.
- EldoLED SOLODrive (SOL) 0-10V 0.1%
- Lutron PEQ0 (L01) Hi-Lume Premier EcoSystem 0.1%
- Lutron LDE1 (L1) EcoSystem 1%
- Electronic low voltage (E) – forward or reverse phase dimming, remodel and AirSeal IC Shallow are FCC Class B
- DALI (D) – DT6 DALI 0.1%
- DMX (DMX) – Digital multiplexing with RDM 0.1%
- Z10, E, and L01 drivers are integral to cylinder, all others are remote

Dimming options:

The following are factory-set for the SOL, D, and DMX driver options (ex. DMXLIN):

- SOL/D/DMX: Logarithmic (-) standard
- SOL/D/DMX: Linear (LIN)
- SOL/DMX: Square (SQR)
- Dim to Warm (D2W): option changes CCT from 3000-1800K gradually as it dims. Use with Z10 dimming only. Fixture-to-fixture consistency of ≤3SDCM at 2700K & 3000K, and ≤5SDCM at 1800K.

Optical systems

Comfort throughout the space:

Patented optical system combines primary and secondary optics to provide a true 50° physical cutoff and 45° reflected cutoff virtually eliminating the view of the light source and bright spots in the reflector. A new reflector

curve reduces reflector brightness by up to 50% compared to existing products, allowing for the use of higher lumen packages in smaller apertures without creating bright spots in the ceiling.

MesoOptics PET optical diffusion film:

Provides a smooth beam shape and mitigates color over angle with optimized luminaire efficiency.

Quality of light: 2 SDCM ensures color consistency from fixture to fixture and over the luminaire's long lifetime. Proprietary optical grade silicone lens with patterned surface provides soft, even beam diffusion without hotspots or dark rings.

ENERGY STAR® exceptions

- 90 CRI configurations
- Champagne Bronze and Black finishes
- EldoLED Solo drivers

Labels and Listings

- cULus listed for wet locations (surface mount)
- cULus listed for damp locations (wall and pendant mount)
- ENERGY STAR® certified
- RoHS certified

Warranty

5 year warranty on complete system.



Complete warranty available at: http://images.philips.com/is/content/PhilipsConsumer/PDFDownloads/United%20States/ODL20150930_003-UPD-en_US-Philips-warranty-indoor-PLS-us.pdf

Polished Reflectors

Shown as round reflectors but represent the finish of Calculite square reflectors.



Specular clear (CL): Most specular and most efficient finish, delivers maximum photometric performance but can produce a mirror image effect of the interior space.



Champagne bronze (CZ): Semi-specular finish that softens light at the source of the reflector while providing a warmer reflector appearance (slightly warmer).



White (WH): (matte) Brightest illuminated aperture and provides the smoothest transition to most ceilings when off (white is only available with a white flange).



Comfort clear (CC): Semi-specular finish that softens the light at the source of the reflector and creates a subtle, even luminance from the reflector cone.



Comfort clear diffuse (CD): Slightly diffuse clear finish, that eliminates iridescence and reduces the mirror image effect inherent with specular finishes.



Black (BK): (anodized) Specular finish that provides the lowest aperture brightness possible and significantly reduces source identification in a ceiling.

C4 Calculite LED 4" gen 3

Cylinder

Dimensions

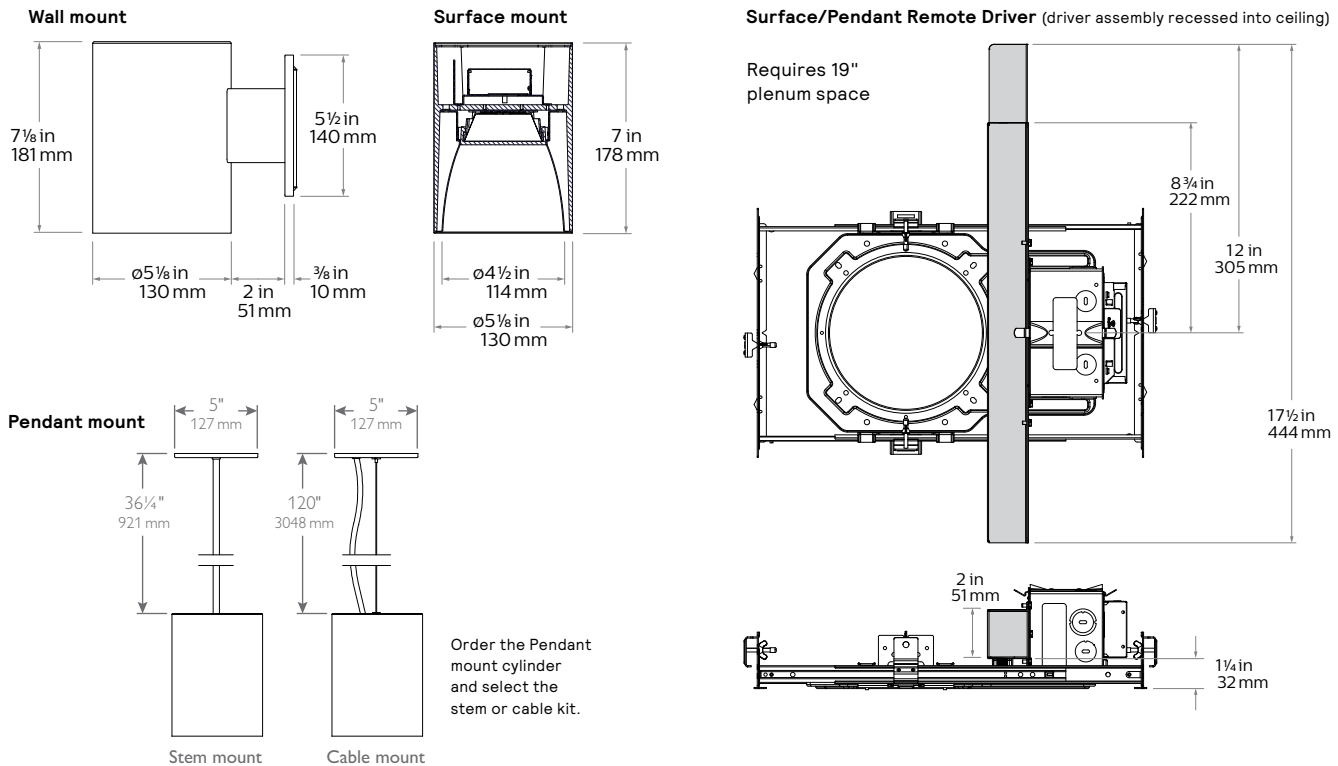

Electrical - Narrow

Light engine	Input Volts	Input Freq.	Input Current	Drive Current	Input Power	LED Power	THD Factor @ Max Load	Power Factor
500lm	120V	50/60Hz	0.050A	0.15A	6.0W	4.8W	<10%	>0.9
	277V	50/60Hz	0.023A	0.15A	6.3W	4.8W	<30%	>0.9
	347V	50/60Hz	0.020A	0.15A	7.0W	4.8W	N/A	>0.9
1000lm	120V	50/60Hz	0.072A	0.22A	8.7W	7.1W	<10%	>0.9
	277V	50/60Hz	0.032A	0.22A	8.9W	7.1W	<20%	>0.9
	347V	50/60Hz	0.029A	0.22A	10.1W	7.1W	<30%	>0.9
1500lm	120V	50/60Hz	0.108A	0.33A	12.9W	10.8W	<10%	>0.9
	277V	50/60Hz	0.047A	0.33A	13.0W	10.8W	<10%	>0.9
	347V	50/60Hz	0.043A	0.33A	14.8W	10.8W	<25%	>0.9
2000lm	120V	50/60Hz	0.147A	0.45A	17.6W	14.9W	<10%	>0.9
	277V	50/60Hz	0.064A	0.45A	17.7W	14.9W	<10%	>0.9
	347V	50/60Hz	0.056A	0.45A	19.6W	14.9W	<20%	>0.9
2500lm	120V	50/60Hz	0.180A	0.55A	21.6W	18.3W	<10%	>0.9
	277V	50/60Hz	0.078A	0.55A	21.7W	18.3W	<10%	>0.9
	347V	50/60Hz	0.066A	0.55A	22.9W	18.3W	<20%	>0.9
3000lm	120V	50/60Hz	0.231A	0.70A	27.7W	23.7W	<10%	>0.9
	277V	50/60Hz	0.100A	0.70A	27.6W	23.7W	<10%	>0.9
	347V	50/60Hz	0.083A	0.70A	28.9W	23.7W	<15%	>0.9

Electrical - Medium & Wide

Light engine	Input Volts	Input Freq.	Input Current	Drive Current	Input Power	LED Power	THD Factor @ Max Load	Power Factor
500lm	120V	50/60Hz	0.051A	0.15A	6.1W	4.8W	<10%	>0.9
	277V	50/60Hz	0.023A	0.15A	6.4W	4.8W	<30%	>0.9
	347V	50/60Hz	0.020A	0.15A	7.1W	4.8W	N/A	>0.9
1000lm	120V	50/60Hz	0.084A	0.25A	10.1W	8.3W	<10%	>0.9
	277V	50/60Hz	0.037A	0.25A	10.3W	8.3W	<10%	>0.9
	347V	50/60Hz	0.034A	0.25A	11.7W	8.3W	<30%	>0.9
1500lm	120V	50/60Hz	0.117A	0.36A	14.0W	11.8W	<10%	>0.9
	277V	50/60Hz	0.051A	0.36A	14.1W	11.8W	<10%	>0.9
	347V	50/60Hz	0.046A	0.36A	16.0W	11.8W	<25%	>0.9
2000lm	120V	50/60Hz	0.153A	0.47A	18.4W	15.5W	<10%	>0.9
	277V	50/60Hz	0.067A	0.47A	18.5W	15.5W	<10%	>0.9
	347V	50/60Hz	0.059A	0.47A	20.3W	15.5W	<20%	>0.9
2500lm	120V	50/60Hz	0.197A	0.60A	23.6W	20.1W	<10%	>0.9
	277V	50/60Hz	0.085A	0.60A	23.6W	20.1W	<10%	>0.9
	347V	50/60Hz	0.072A	0.60A	24.9W	20.1W	<20%	>0.9
3000lm	120V	50/60Hz	0.247A	0.75A	29.7W	25.5W	<10%	>0.9
	277V	50/60Hz	0.107A	0.75A	29.7W	25.5W	<10%	>0.9
	347V	50/60Hz	0.087A	0.75A	30.4W	25.5W	<15%	>0.9

C4 Calculite LED 4" gen 3

Cylinder

Lifetime (TM-21) data

Lumens	Narrow beam	Medium/Wide beam
500lm		
1000lm	L85 @ 55,000hrs.	L90 @ 60,000hrs.
1500lm		
2000lm	L85 @ 55,000hrs.	L80 @ 60,000hrs.

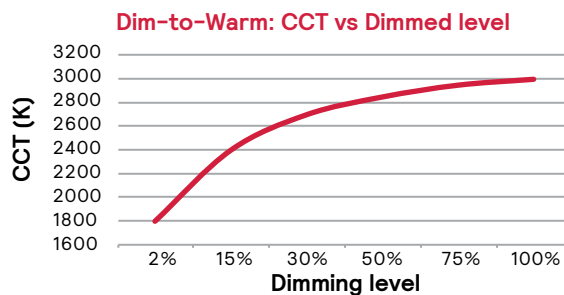

AccuRender Technology (CRI 90+)

The right light brings colors to life. Our new AccuRender technology helps ensure colors are rendered more accurately and consistently, while doing so as efficiently as CRI 80 products.



Standard CRI 80
Good color rendering and high efficacy



Standard CRI 90
Better color rendering and low efficacy



AccuRender
Best color rendering, color preference and high efficacy

Enjoy design flexibility

Full range of products and options:

- Available soon in across Lightlier portfolio for application flexibility
- Multiple color temperatures (CCTs) and lumen packages offered

Promote savings

High efficacy, with no penalty:

- Energy efficacy compares well to conventional 80 CRI
- Up to 25% more energy savings vs competitor 90 CRI¹
- Helps meet Title 24 requirements

Show your true colors

High color rendering:

- True to life colors that help energize your environment and render better flesh tones critical for healthcare hospitality and retail applications.
- R_a up to 94 CRI
- R_g up to 67 CRI
- G_s up to 99 CRI
- C_9 up to 94 CRI
- R_f up to 92 TM-30
- $R_{f,hl}$ up to 91 TM-30
- R_g up to 100 TM-30
- $R_{cs,hl}$ up to -5% TM-30

Achieve color balance

Best in class color consistency:

- Promote aesthetic harmony in your space with ≤ 2 SDCM

Round Downlight

Photometric - Downlights with CRI of 90+ & R9 of 50+

Lumen Package	Beam	Flux (lm)	Efficacy (lm/W)	Beam Angle	CBCP	CRI	R9	IES TM-30-18			UGR
								R_f	R_g	$R_{cs,hl}$	
500 lm	Narrow (N)	609	101	39°	1409	90+	50+	91	100	-6%	0
	Medium (M)	625	102	53°	769	90+	50+	91	99	-6%	0
	Wide (W)	570	93	69°	378	90+	50+	91	99	-6%	0
1000 lm	Narrow (N)	905	104	39°	2094	90+	50+	91	100	-6%	0
	Medium (M)	1056	105	53°	1300	90+	50+	91	99	-6%	0
	Wide (W)	963	95	69°	638	90+	50+	91	99	-6%	0
1500 lm	Narrow (N)	1347	101	39°	3118	90+	50+	91	100	-6%	1
	Medium (M)	1510	108	53°	1859	90+	50+	91	99	-6%	2
	Wide (W)	1385	99	69°	917	90+	50+	91	99	-6%	1
2000 lm	Narrow (N)	1778	101	39°	4115	90+	50+	91	100	-6%	2
	Medium (M)	1937	105	53°	2385	90+	50+	91	99	-6%	2
	Wide (W)	1779	97	69°	1178	90+	50+	91	99	-6%	2

Round Wall Wash

Photometric - Downlights with CRI of 90+ & R9 of 50+

Lumen Package	Beam	Flux (lm)	Efficacy (lm/W)	Beam Angle	CBCP	CRI	R9	IES TM-30-18			UGR
								R_f	R_g	$R_{cs,hl}$	
500 lm	Open (WW)	555	91	-	-	90+	50+	91	99	-6%	10
	Lensed (LW)	396	65	-	-	90+	50+	91	99	-6%	16
1000 lm	Open (WW)	937	93	-	-	90+	50+	91	99	-6%	12
	Lensed (LW)	668	66	-	-	90+	50+	91	99	-6%	18
1500 lm	Open (WW)	1348	96	-	-	90+	50+	91	99	-6%	13
	Lensed (LW)	961	69	-	-	90+	50+	91	99	-6%	19
2000 lm	Open (WW)	1731	94	-	-	90+	50+	91	99	-6%	14
	Lensed (LW)	1234	67	-	-	90+	50+	91	99	-6%	20

C4 Calculite LED 4" gen 3

Cylinder

interact

	Gateway Connected		
	Standalone	Option 1	Option 2
Dimming, grouping, and zoning	✓	✓	✓
Bluetooth and ZigBee enabled	✓	✓	✓
Motion sensing and daylight harvesting	✓	✓	✓
Integration with 0-10V and phase dimming fixtures	✓	✓	✓
Code compliance	✓	✓	✓
Granular dimming and dwell time	✓	✓	✓
Correlated color temperature (CCT) tuning by switch	New ✓	✓	✓
Support for sensor-based Tunable White luminaires	New ✓	✓	✓
Energy reporting and monitoring		✓	✓
Scheduling		✓	✓
Demand response		✓	✓
BMS integration (BACnet)			✓
Floor plan visualization			✓
IoT sensors for wellness			✓
IoT Apps for productivity			✓

Currently supported maximum system size

To be able to design the lighting system correctly for the customer, it is important to know the prime characteristics of the system, its possibilities and limitations.

System level	
Total number of gateways	Unlimited
Total number of devices	200 per network
• Luminaires with integrated sensors	150
• Smart TLEDS	150
• Zones + groups	64
Total number of ZGP devices (sensors and switches)	50
• Sensors	30
• Switches	50

Group level	
Recommended number of lights	40 (maximum 150)
Number of ZGP devices	5
Number of scenes	16

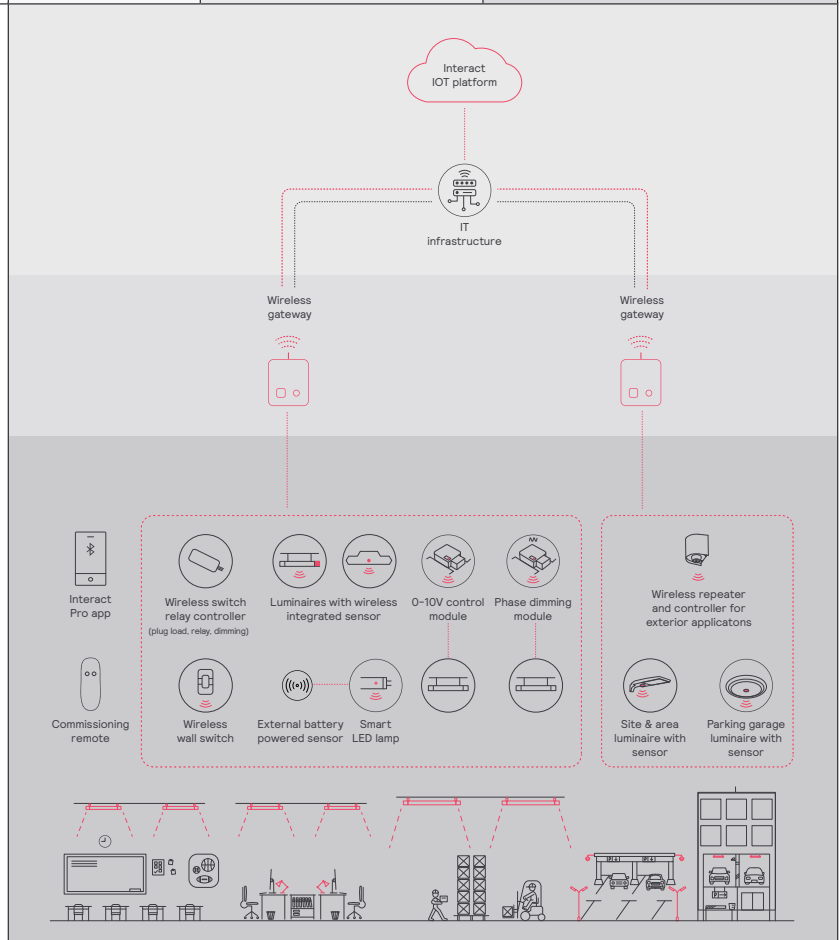

C4 Calculite LED 4" gen 3

Cylinder

Wireless controls options

Interact

- SWZCS is a connected sensor with integral occupancy and daylight sensing and supports wireless mesh connectivity.
- The sensor works in the standalone mode (similar to SpaceWise) when configured without a gateway or in a cloud connected mode if a compatible gateway is used.
- Interact includes an App, a portal and a broad portfolio of wireless luminaires, lamps and retrofit kits all working on the same system.
- Startup is implemented via Interact Pro App (Android or iPhone) & Bluetooth connectivity. The App provides flexibility to choose between a gateway or non gateway mode for setup.
- Setup with the gateway requires wired internet access to the gateway. It is possible to add a gateway at a later point.
- Prepare project configuration steps remotely and use IRT9015 remote on-site to identify and group devices together.

Compatible with:

- SWS200 & UID8465 wireless scene switch
- Battery powered IP42 presence sensor OCC sensor IA CM WH 10/1
- Battery powered IP42 presence & daylight sensor OCC-DL sensor IA CM IP42 WH
- LCN3110: battery powered IP65 presence sensor, OCC sensor IA CM IP65W
- LCN3120: battery powered IP65 presence & daylight sensor, OCC-DL sensor IA CM IP65 WH
- For more information on Interact visit: interact-lighting.com/interactproscalablesystem

Radio only sensor (RA or RADIO)

- Integral RA or RADIO only sensor simply enables wireless mesh connectivity to the luminaire without any occupancy or daylight sensing.
- Ideal for applications where sensing functionality is managed by other Interact devices and the luminaire only needs to have wireless connectivity.
- Interact includes an App, a portal and a broad portfolio of wireless luminaires, lamps and retrofit kits all working on the same system.
- Startup is implemented via Interact Pro App (Android or iPhone) & Bluetooth connectivity. The App provides flexibility to choose between a gateway or non-gateway mode for setup.
- Setup with the gateway requires wired internet access to the gateway. It is possible to add a gateway at a later point.
- Prepare project configuration steps remotely, identify and group devices together onsite.
- Compatible with SWS200 and UID8465 wireless scene switch, wireless Occ sensor (OCC SENSOR IA CM IP42 WH 10/1) and wireless Day/Occ sensor (OCC MULTI SENSOR IA CM WH 10/1).
- For more information on Interact visit: interact-lighting.com/interactproscalablesystem

Sensor bundle (IAOSB or SB)

- A wireless IoT connected lighting solution for large enterprises that span across multiple floors, buildings and require multiple gateways.
- View all your projects under one dashboard and easily compare insights from multiple projects in one view.
- Compatible with SWS200 wireless scene switch, wireless Occ sensor (OCC SENSOR IA CM IP42 WH 10/1) and wireless Day/Occ sensor (OCC MULTI SENSOR IA CM WH 10/1) and wireless Occupancy or Daylight & Occupancy sensors available. Use Interact software and insights to increase building efficiency, achieve building wide integration and optimize space through occupancy analytics.
- IAOSB or SB option in addition to occupancy and daylights sensing supports advanced IoT capabilities, such as people estimation analysis, desk level temperature & humidity sensing, noise classification, and BLE beacon.
- Requires compatible Gateway and internet connectivity for commissioning.
- For more information, visit: interact-lighting.com/interactproscalablesystem

Emergency Options (ER100)

- **Power Sensing** (factory default) – Recommended UL924 option requires unswitched power sense line, absence of voltage on the normal circuit triggers luminaire to 100% output.
- **Power Interruption Detection** (field option) – Detects AC power interruption >30ms triggers 90 minute emergency mode with luminaire at 100% output.

Wired controls options

Interact (PoE):

- PoE based IoT connected lighting solution for large enterprises that span across multiple floors, buildings and require multiple gateways.
- Use Interact software and insights to increase building efficiency, achieve building wide integration and optimize space through occupancy analytics.
- Test switch and indicator light mounted on side of chassis on one end.
- Supports advanced IoT Apps on Personal Control, Space Management, wayfinding, room/desk reservation and offers open APIs for light control and data exchange.
- Integral sensor option for occupancy sensing (PIR) and/or daylight harvesting available for additional energy savings.
- Optional integral emergency controller and battery pack provides 600lm nominal output.
- PoE lighting controller is accessible from below.
- Emergency battery has a 3 month pre-installed shelf life, and must be stored and installed in environments of 20C to 30C (-4F to 86F) ambient, and 45-85% relative humidity.
- For more information on Interact Office Wired, visit: interact-lighting.com/office or www.usa.lighting.philips.com/systems/system-areas/offices.

Interact supported sensor option codes across Genlyte product lines

	Evokit	Day-Brite	Ledalite	Lightolier
ZigBee + Bluetooth + Sensing	SWZCS	SWZCS	CS	SBA accessory (external)
ZigBee + Bluetooth	RADIO	RADIO	RA	RA
ZigBee + Bluetooth + Sensing + Environmental data	IAOSB	IAOSB	SB	SB
ZigBee + Highbay + Sensing	-	SWZCSH	-	-

C4 Calculite LED 4" gen 3

Cylinder

Narrow beam, 1500lm Engine, 117lm/W at 13W

Candela Curve

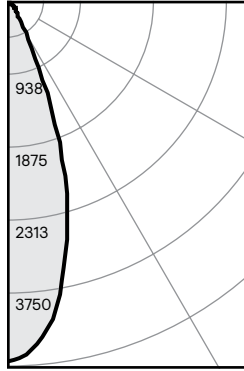

C4SDL15935NZ10UCLW

Output lumens: 1492 lms
 Input watts: 12.8 W
 CRI: 90 min
 CCT: 3500K
 Spacing Crit.: 0.62
 Beam Angle: 36°

Zonal summary

Zone	Lumens	%Luminaire
0-30	1322	88.6%
0-40	1437	96.3%
0-60	1490	99.9%
0-90	1492	100.0%

Angle	Mean CP	Lumens
0	3676	
5	3512	
10	3039	320
15	2364	
20	1536	639
25	769	
30	312	363
35	171	
40	135	115
45	64	
50	8	51
55	2	
60	1	2
65	1	
70	0	1
75	0	0
80	0	0
85	0	0
90	0	0

Single unit data

Height to lighted plane	Initial center beam foot-candles	Beam diameter (ft)*
5'	102	4.8'
6'	80	5.4'
7'	65	6.0'
8'	45	6.6'
9'	19	8.7'

* Beam diameter is where foot-candles drop to 50% of maximum.

Multiple unit data - RCR 2

Spacing on center	Initial center beam foot-candles	Watts per sq. ft.
5'	63.0	0.57
6'	42.0	0.37
7'	30.0	0.27
8'	25.0	0.22
9'	20.0	0.18

38' x 38' x 10' Room, Workplane 2.5' above floor, 80/50/20% Reflectances

Efficacy: 116.6 lm/W
 Report#: STMR-2974

Adjustment factors

Finish	CCT	Lumens
CL = 100%	90CRI, 4000K = 102%	3000lm = 200%
CC = 95%	90CRI, 3500K = 100%	2500lm = 167%
CD = 87%	90CRI, 3000K = 96%	2000lm = 133%
CZ = 63%	90CRI, 2700K = 92%	1500lm = 100%
WH = 87%		1000lm = 67%
BK = 57%		500lm = 33%

Coefficients of utilization

Ceiling	80%		70%		50%		30%		0%			
	70	50	30	10	50	10	50	10	50	10	0	
Wall	70	50	30	10	50	10	50	10	50	10	0	
RCR	Zonal cavity method - Effective floor reflectance = 20%											
Room Cavity Ratio	0	119	119	119	119	116	116	111	111	106	106	100
	1	114	112	110	108	110	106	106	103	102	100	95
	2	110	106	103	100	104	99	101	96	98	94	91
	3	106	100	96	93	99	92	97	91	94	89	87
	4	102	96	91	88	94	87	92	86	91	85	83
	5	98	91	86	83	90	82	89	82	87	81	79
	6	94	87	82	79	86	78	85	78	84	77	76
	7	91	83	78	75	83	75	82	74	80	74	73
	8	88	80	75	72	79	72	78	71	77	71	70
	9	85	77	72	69	76	69	75	68	75	68	67
	10	82	74	69	66	73	66	73	66	72	66	64

Medium beam, 1500lm Engine, 108lm/W at 14W

Candela Curve

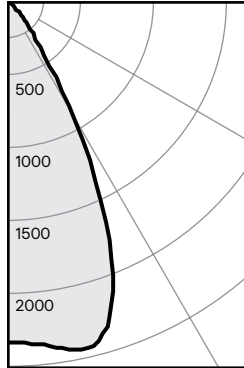

C4SDL15935MZ10UCLW

Output lumens: 1510 lms
 Input watts: 14.0 W
 CRI: 90 min
 CCT: 3500K
 Spacing Crit.: 0.92
 Beam Angle: 54°

Zonal summary

Zone	Lumens	%Luminaire
0-30	1242	82.3%
0-40	1450	96.0%
0-60	1508	99.9%
0-90	1510	100.0%

Angle	Mean CP	Lumens
0	1859	
5	1871	
10	1924	180
15	1910	
20	1677	527
25	1204	
30	661	535
35	307	
40	154	208
45	69	
50	9	55
55	2	
60	1	3
65	1	
70	0	1
75	0	0
80	0	0
85	0	0
90	0	0

Single unit data

Height to lighted plane	Initial center beam foot-candles	Beam diameter (ft)*
5'	74	4.6'
6'	52	5.5'
7'	38	6.4'
8'	29	7.4'
9'	23	8.3'

* Beam diameter is where foot-candles drop to 50% of maximum.

Multiple unit data - RCR 2

Spacing on center	Initial center beam foot-candles	Watts per sq. ft.
5'	70.0	0.62
6'	46.0	0.41
7'	32.0	0.29
8'	27.0	0.24
9'	22.0	0.19

38' x 38' x 10' Room, Workplane 2.5' above floor, 80/50/20% Reflectances

Efficacy: 107.9 lm/W
 Report#: STMR-1613

Adjustment factors

Finish	CCT	Lumens
CL = 100%	90CRI, 4000K = 102%	3000lm = 200%
CC = 95%	90CRI, 3500K = 100%	2500lm = 167%
CD = 87%	90CRI, 3000K = 96%	2000lm = 133%
CZ = 63%	90CRI, 2700K = 92%	1500lm = 100%
WH = 87%		1000lm = 67%
BK = 57%		500lm = 33%

Coefficients of utilization

Ceiling	80%		70%		50%		30%		0%			
	70	50	30	10	50	10	50	10	50	10	0	
Wall	70	50	30	10	50	10	50	10	50	10	0	
RCR	Zonal cavity method - Effective floor reflectance = 20%											
Room Cavity Ratio	0	119	119	119	119	116	116	111	111	106	106	100
	1	114	111	109	107	109	105	105	102	101	99	94
	2	109	104	101	97	103	96	99	94	96	92	89
	3	104	98	93	90	97	89	94	88	92	86	83
	4	99	92	87	83	91	83	89	82	87	81	79
	5	95	87	82	78	86	77	84	77	83	76	74
	6	90	82	77	73	81	72	80	72	79	72	70
	7	86	78	72	68	77	68	76	68	75	67	66
	8	83	74	68	64	73	64	72	64	71	64	62
	9	79	70	65	61	70	61	69	61	68	60	59
	10	76	67	61	58	66	58	65	57	65	57	56

1. Correlated Color Temperature within specs as defined in ANSI_NEMA_ANSI C78.377-2008: Specifications for the Chromaticity of Solid State Lighting Products.
 2. Tested using absolute photometry as specified in LM79: IESNA Approved Method for the Electrical and Photometric Measurements of Solid-State Lighting Products.

C4 Calculite LED 4" gen 3

Cylinder

Wide beam, 1500lm Engine, 99lm/W at 14W

Candela Curve

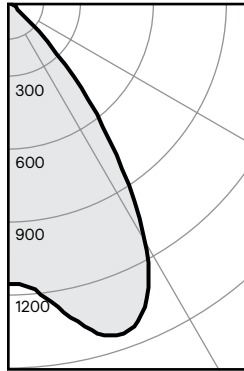

C4SDL15935WZ10UCLW

Output lumens: 1385 lms
 Input watts: 14.0 W
 CRI: 90 min
 CCT¹: 3500K
 Spacing Crit.: 1.26
 Beam Angle: 67°

Zonal summary

Zone	Lumens	%Luminaire
0-30	886	64.0%
0-40	1264	91.3%
0-60	1384	99.9%
0-90	1385	100.0%

Angle	Mean CP	Lumens
0	917	
5	941	
10	1025	93
15	1116	
20	1135	314
25	1063	
30	873	479
35	606	
40	366	378
45	134	
50	15	116
55	3	
60	2	4
65	1	
70	1	1
75	0	
80	0	0
85	0	
90	0	0

Single unit data

Height to lighted plane	Initial center beam foot-candles	Beam diameter (ft)*
5'	37	6.3'
6'	25	7.6'
7'	19	8.8'
8'	14	10.1'
9'	11	11.3'

* Beam diameter is where foot-candles drop to 50% of maximum.

Multiple unit data - RCR 2

Spacing on center	Initial center beam foot-candles	Watts per sq. ft.
5'	63.0	0.62
6'	42.0	0.41
7'	29.0	0.29
8'	25.0	0.24
9'	20.0	0.19

38' x 38' x 10' Room, Workplane 2.5' above floor, 80/50/20% Reflectances

Efficacy: 98.9lm/W
 Report#: STMR-1641.1

Adjustment factors

Finish	CCT	Lumens
CL = 100%	90CRI, 4000K = 102%	3000lm = 200%
CC = 95%	90CRI, 3500K = 100%	2500lm = 167%
CD = 87%	90CRI, 3000K = 96%	2000lm = 133%
CZ = 63%	90CRI, 2700K = 92%	1500lm = 100%
WH = 87%		1000lm = 67%
BK = 57%		500lm = 33%

Coefficients of utilization

Ceiling	80%		70%		50%		30%		0%	
	70	50	30	10	50	10	50	10	50	10
Wall	70	50	30	10	50	10	50	10	50	10
RCR	Zonal cavity method - Effective floor reflectance = 20%									
Room Cavity Ratio	0	119	119	119	116	116	111	111	106	106
1	113	110	108	106	108	104	104	101	100	98
2	107	102	98	95	101	93	97	91	94	89
3	102	95	90	85	93	85	91	83	88	82
4	96	88	82	78	87	77	85	76	83	75
5	91	82	76	71	81	71	79	70	77	70
6	86	76	70	65	75	65	74	65	72	64
7	81	71	65	60	70	60	69	60	68	59
8	77	66	60	56	66	56	65	55	64	55
9	72	62	56	52	62	52	61	51	60	51
10	69	58	52	48	58	48	57	48	56	46

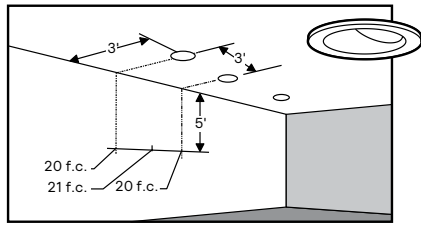

Lighting Data - Example

C4RWVCL / C4L15935W
 illumination on the wall
 5' down from the ceiling is 20 f.c.
 beneath and 21 f.c. between fixtures.

Adjustment factors

Finish	CCT	Lumens
CL = 100%	90CRI, 4000K = 102%	3000lm = 200%
CC = 95%	90CRI, 3500K = 100%	2500lm = 167%
CD = 87%	90CRI, 3000K = 96%	2000lm = 133%
CZ = 63%	90CRI, 2700K = 92%	1500lm = 100%
WH = 87%		1000lm = 67%
BK = 57%		500lm = 33%

Open Wall Wash, 1500lm Engine, 96lm/W at 14W

Candela Curve

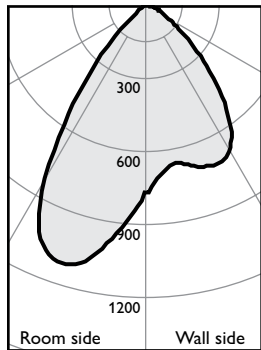

C4SWW15935WZ10UCLW

Output lumens: 1348 lms
 Input watts: 14.0 W
 CRI: 90 min
 CCT¹: 3500K

Efficacy: 96.3 lm/w
 Report#: STMR-1614.2

Multiple unit data

Distance from ceiling in feet	Footcandles on wall		
	2' from wall		3' on ctr.
1	16	13	16
2	30	25	30
3	32	30	32
4	27	27	27
5	20	21	20
6	16	16	16
7	12	13	12
8	9	10	9
9	8	8	8
10	6	6	6
12	5	5	5
14	4	5	4

Multiple unit data

Distance from ceiling in feet	Footcandles on wall		
	3' from wall		3' on ctr.
1	7	6	7
2	13	13	13
3	19	18	19
4	21	21	21
5	20	21	20
6	18	18	18
7	14	15	14
8	12	12	12
9	10	10	10
10	8	8	8
12	7	7	7
14	6	6	6

Multiple unit data

Distance from ceiling in feet	Footcandles on wall		
	3' from wall		4' on ctr.
1	6	5	6
2	11	9	11
3	16	13	16
4	17	16	17
5	16	16	16
6	14	14	14
7	12	12	12
8	10	10	10
9	8	8	8
10	7	7	7
12	6	6	6
14	5	5	5

1. Correlated Color Temperature within specs as defined in ANSI_NEMA_ANSI C78.377-2008: Specifications for the Chromaticity of Solid State Lighting Products.
 2. Tested using absolute photometry as specified in LM79: IESNA Approved Method for the Electrical and Photometric Measurements of Solid-State Lighting Products.