

CHLORIDE

by  signify

INSTALLATION & OPERATION INSTRUCTIONS

UNIVERSAL RECESSED / SURFACE MOUNT LED EXIT SIGN
EMERGENCY BATTERY BACKUP

Package Contents

Part	Description	Quantity
1	LED Edge-Lit EXIT Sign	1
2	Recessed box and Bar hanger	1
3	Hardware Bag	1

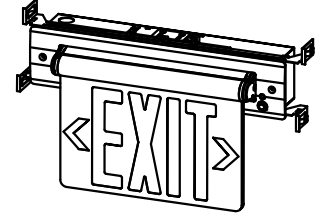

IMPORTANT SAFEGUARDS

READ AND FOLLOW ALL SAFETY INSTRUCTIONS.

When using electrical equipment, basic safety precautions should always be followed including the following

1. Before starting the installation, disconnect AC power by turning off the circuit breaker or by removing the appropriate fuse at the fuse box. Using the light switch to turning the power off is not sufficient to prevent electrical shock.
2. Do not use outdoors.
3. Do not mount near gas or electric heaters.
4. Use caution when servicing batteries. Battery acid can cause burns to skin and eyes. If acid is spilled on skin or eyes, flush acid with fresh water and contact a physician immediately.
5. Equipment should be mounted in locations and at heights where it will not be subjected to tampering by unauthorized personnel.
6. The use of accessory equipment not recommended by the manufacturer may cause an unsafe condition.
7. Do not use this equipment for other than its intended use.
8. All servicings should be performed by a qualified personnel only.
9. Allow battery to charge for 24 hours before first use.

SAVE THESE INSTRUCTIONS

MAINTENANCE

Battery have to recharge if product keep in stock over 9 months, detail manual refer "BATTERY STOCK AND RECHARGE GUIDELINE". We recommend that the equipment be tested regularly in accordance with local codes. Replace the batteries as needed if discharge time do not achieve 90 minutes,

OPERATION

Press the test button, unit will be illuminated by battery backup and the LED indicator will be turned off. Release the test switch, LED indicator will be turned on.

ELECTRICAL CONNECTIONS

- If using 120VAC, connect the black and white wires to the building utility.
- If using 277VAC, connect the orange and white wires to the building utility.
- Connect ground wires to building utility.
- Cap off unused wires. In all cases, use standard wire nuts in connection to wires.

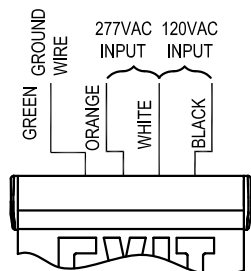

DETERMINE DIRECTION

- If need chevron indicator, remain chevron and remove instruction film.
- If no need chevron indicator, remove chevron and instruction film together.



▲ NOTICE-MUST WEAR GLOVES FOR ALL INSTALLATION PROCESSES

Recessed Ceiling Mounting

1. Use screwdriver open front cover and connect battery connector. feed the AC wires out of housing.

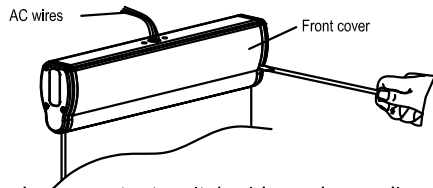

2. Unscrew and remove test switch side end cap, disconnect test switch connector, remove test switch and LED indicator and bushing from end cap, feed test switch and LED indicator wire out of end cap, restore end cap on housing by screws.

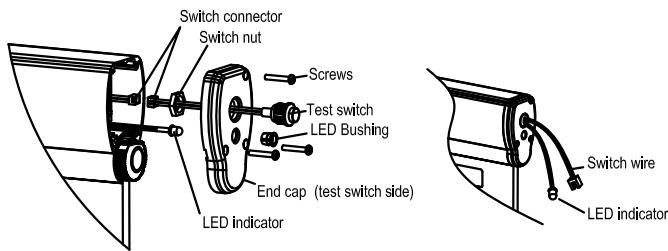

3. Unscrew and remove trim plate from metal box, fix test switch and LED bushing on the trim plate.

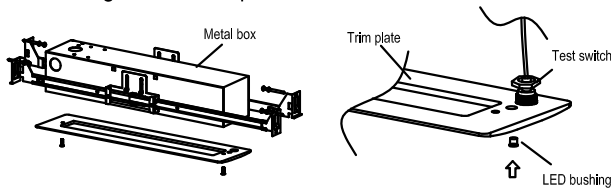

4. Pry off J-box cover by flat screw driver, punch out appropriate hole for AC wires feed in.

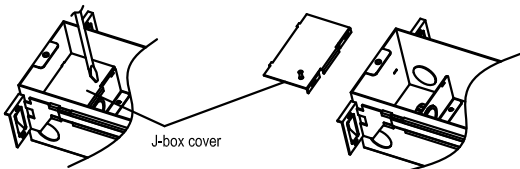

5. Position recessed kits and bar hangers between joists. Make sure bar hangers to be hanged in the correct position. Position recessed kits temporarily by hammering "nail-in" tabs on bar hangers, then secure permanently with nails. Bar hangers should be level with bottom of joists .

6. Adjust height of recessed kits vertically using adjusting slots and then tightening all screws on adjusting slots and bar hanger bracket to secure adjusting bracket and bar hangers .

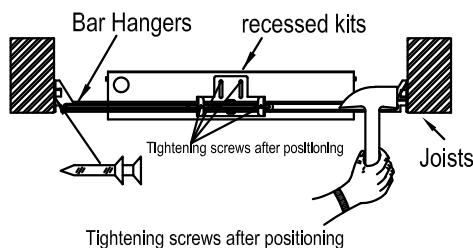

7. Feed AC wires from fixture inside of J-box, make proper electrical connections at J-box in the metal housing, refer "*ELECTRICAL CONNECTIONS*". Restore J-box cover after wire connections, insert one side first and snap in another side. You may use holding wire during wiring

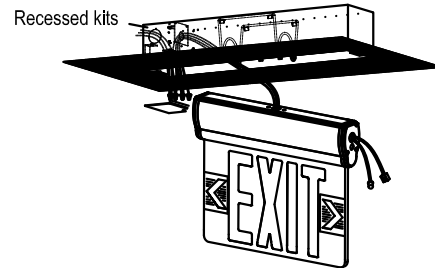

8. Insert fixture into metal box and snap by spring, connect test switch, assemble LED indicator on bushing at trim plate. fix trim plate on the metal box by 2 screws.

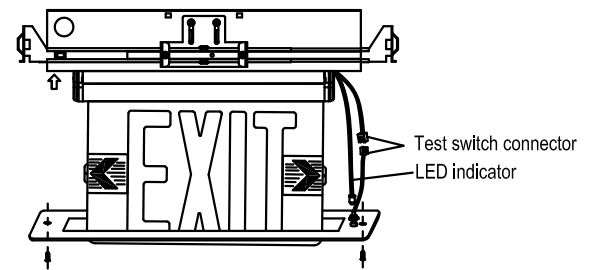

9. Peel off protective film from acrylic panel.

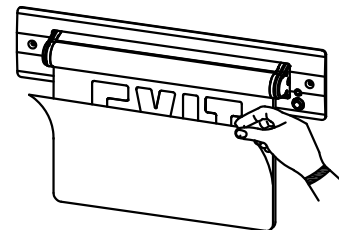

10. Determine direction for chevron indicator. (See DETERMINE DIRECTION)

Recessed Wall Mounting

1. Reference 1 - 10 step in recessed ceiling mounting above for recessed wall mounting.
2. Recessed ceiling mounting rotate 90° become recessed Wall mounting.

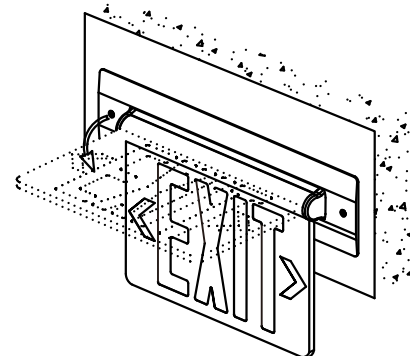

▲ NOTICE-MUST WEAR GLOVES FOR ALL INSTALLATION PROCESSES

NOTE: First turn off electricity.

Surface Ceiling & Wall Mounting

1. Attach crossbar to junction box.(TM8#-32*-1)
2. Use screwdriver open front cover to connect battery connector.

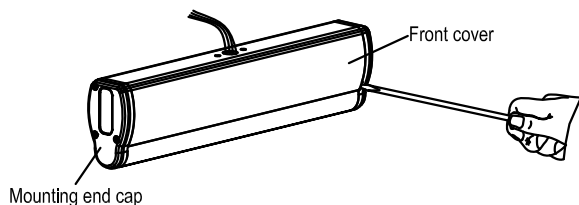

3. Feed AC supply wires through canopy center hole.
4. Assemble canopy onto main body assembly with (2) PM4*12 screws(supplied) and make proper wire connections.
(See ELECTRICAL CONNECTIONS).
5. Use (2) PM4-40 screws (supplied) tighten canopy to crossbar.

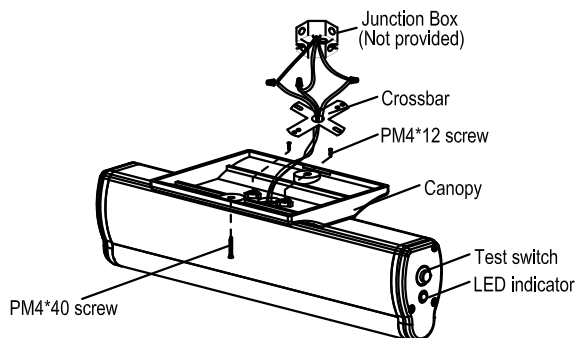

6. Peel off protection film from EXIT panel, insert EXIT panel into main body assembly gently.
If EXIT panel is for single face, make sure EXIT letter direction is correct.

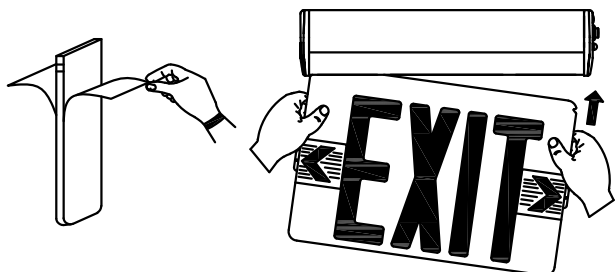

7. Determine direction for chevron placement.
(See DETERMINE DIRECTION)

8. The unit can be installed on any surface, you may rotate the EXIT panel in any angle from 0° to 180°, Ceiling mounting rotate 90° become Wall mounting.

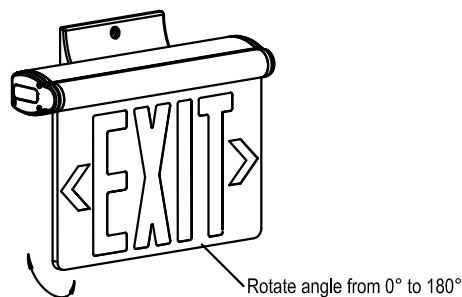

Surface Side Mounting

1. Attach crossbar to junction box.
2. Use screwdriver open front cover to connect battery connector.
3. Remove the hole plug from mounting end cap.
4. Pull out all AC supply wires and feed wires thru the center holes of mounting end cap and then canopy.
5. Reference 4 - 8 step in surface ceiling & wall mounting above for surface end mounting.

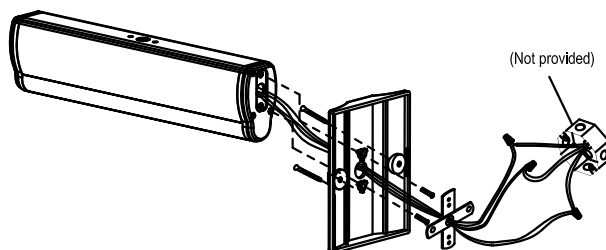

MAINTENANCE

Battery have to recharge if product keep in stock over 9 months, detail manual refer "BATTERY STOCK AND RECHARGE GUIDELINE". We recommend that the equipment be tested regularly in accordance with local codes. Replace the batteries as needed if discharge time do not achieve 90 minutes,

OPERATION

Press the test button, unit will be illuminated by battery backup and the LED indicator will be turned off. Release the test switch, LED indicator will be turned on.

TROUBLE SHOOTING GUIDE

If LED heads or LED indicator does not illuminate, check the following:

1. Check AC supply - verify that unit has 24 hours AC supply.
2. Battery connection.
3. Discharge battery and charge battery for 24 hours and then retest.
4. If above trouble shooting hints do not solve the problem, contact factory for assistance.