

CRDS / CRFS / AC / VC > CAST BRACKETS AND SHORT REACH BRACKETS

CRDS

EPA: 1.13 sq.ft. Weight: 19.0 lbs. (8.6 kg)

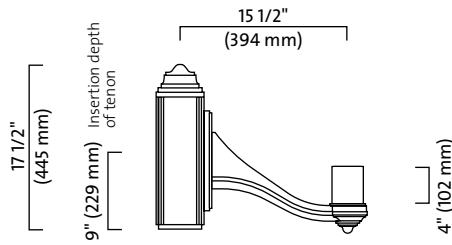

CRFS

EPA: 1.12 sq.ft. Weight: 19.0 lbs. (8.6 kg)

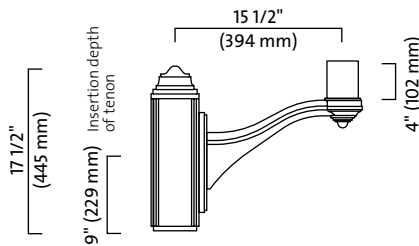

AC

EPA: 1.45 sq.ft. Weight: 15.0 lbs. (6.8 kg)

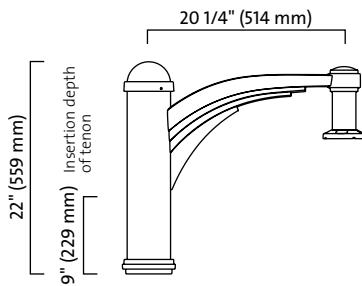

VC

EPA: 1.65 sq.ft. Weight: 16.0 lbs. (7.3 kg)

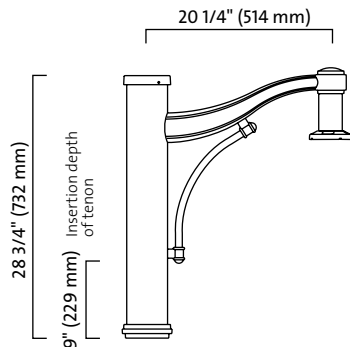

Specifications:

The CRDS / CRFS mounting arms feature a cast-aluminum curved arm mechanically assembled to a cast-aluminum plate.

The mounting arms are equipped with a 3" round (76 mm) by 3" high (76 mm) tenon for luminaire mounting.

The CRDS / CRFS plates are mechanically fastened by stainless steel hardware to a central pole adaptor slip-fitting 9" (229 mm) over a 4" (102 mm) O.D. pole or tenon.

Configurations

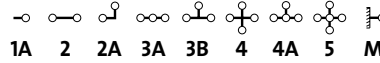

Mid-pole Configurations

> with pole option MPL



Specifications:

The AC mounting arm features a cast-aluminum curved arm, welded to the central pole adaptor.

The luminaire adaptor will accept a luminaire equipped with Lumec's four-bolt mounting system.

The central pole adaptor slip-fits 9" (229 mm) over a 4" (102 mm), 5" (127 mm) or 5 9/16" (141 mm) O.D. pole or tenon.

Configurations

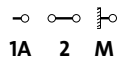

Mid-pole Configurations

> with pole option MPL



Specifications:

The VC mounting arm features a cast-aluminum curved arm welded to the central pole adaptor.

The mounting arm includes an extruded-aluminum decorative curved tubing welded to the side of the central pole adaptor and to the arm.

The luminaire adaptor will accept a luminaire equipped with Lumec's four-bolt mounting system.

The central pole adaptor slip-fits 9" (229 mm) over a 4" (102 mm), 5" (127 mm) or 5 9/16" (141 mm) O.D. pole or tenon.

Configurations

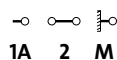

Mid-pole Configurations

> with pole option MPL



Note: Lumec reserves the right to modify the above details to reflect changes in the cost of materials and/or production and/or design without prior notice.

LUMEC

CRA

EPA: 1.40 sq.ft. Weight: 16.0 lbs. (7.3 kg)

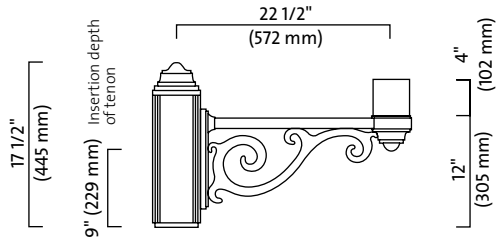

Specifications:

The **CRA** mounting arm features a seamless 1" x 2" (25 x 51 mm) rectangular extruded aluminum tube and cast decorative scroll, welded to a cast-aluminum plate.

The mounting arm is equipped with a 4" round (102 mm) by 4" high (102 mm) tenon for luminaire mounting.

The **CRA** plate is mechanically fastened using stainless steel hardware to a central pole adaptor slip-fitting 9" (229 mm) over a 4" (102 mm) O.D. pole or tenon.

Configurations



Mid-pole Configurations

> with pole option MPL



CRAT

EPA: 1.45 sq.ft. Weight: 37.0 lbs. (16.8 kg)

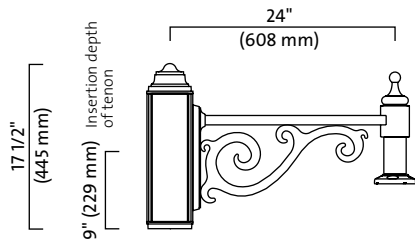

Specifications:

The **CRAT** mounting arm features a seamless 1" x 2" (25 x 51 mm) rectangular extruded aluminum tube and cast decorative scroll, welded to a cast-aluminum plate.

The luminaire adaptor will accept a luminaire equipped with Lumec's four-bolt mounting system.

The **CRAT** plate is mechanically fastened using stainless steel hardware to a central pole adaptor slip-fitting 9" (229 mm) over a 4" (102 mm) O.D. pole or tenon.

Configurations

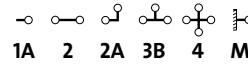

Mid-pole Configurations

> with pole option MPL



CRC

EPA: 1.39 sq.ft. Weight: 17.0 lbs. (7.7 kg)

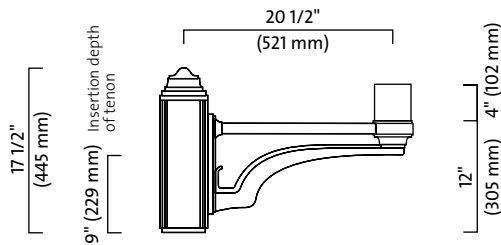

Specifications:

The **CRC** mounting arm features a seamless 1" x 2" (25 x 51 mm) rectangular extruded aluminum tube and cast decorative scroll, welded to a cast-aluminum plate.

The mounting arm is equipped with a 4" round (102 mm) by 4" high (102 mm) tenon for luminaire mounting.

The **CRC** plate is mechanically fastened using stainless steel hardware to a central pole adaptor slip-fitting 9" (229 mm) over a 4" (102 mm) O.D. pole or tenon.

Configurations



Mid-pole Configurations

> with pole option MPL



CRFT

EPA: 1.32 sq.ft. Weight: 21.0 lbs. (9.5 kg)

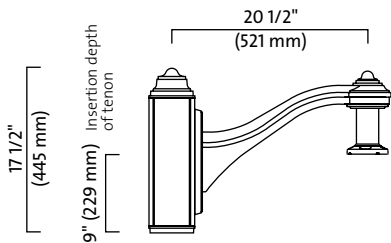

Specifications:

The **CRFT** mounting arm features a cast-aluminum curved arm mechanically assembled to a cast-aluminum plate.

The luminaire adaptor will accept a luminaire equipped with Lumec's four-bolt mounting system.

The **CRFT** plate is mechanically fastened using stainless steel hardware to a central pole adaptor slip-fitting 9" (229 mm) over a 4" (102 mm) O.D. pole or tenon.

Configurations

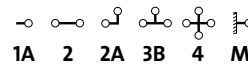

Mid-pole Configurations

> with pole option MPL



YR / AR / CRD / CRF > CAST BRACKETS

YR

EPA: 1.30 sq.ft. Weight: 40.0 lbs. (18.1 kg)

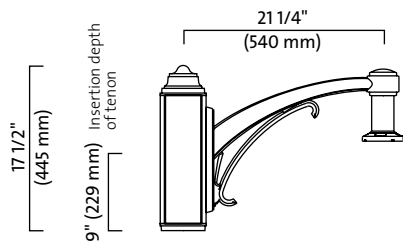

AR

EPA: 1.35 sq.ft. Weight: 40.0 lbs. (18.1 kg)

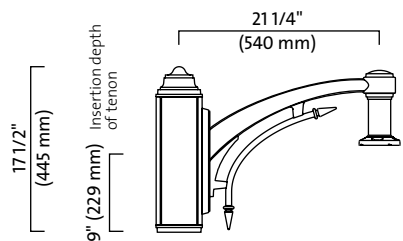

CRD

EPA: 1.34 sq.ft. Weight: 25.0 lbs. (11.3 kg)

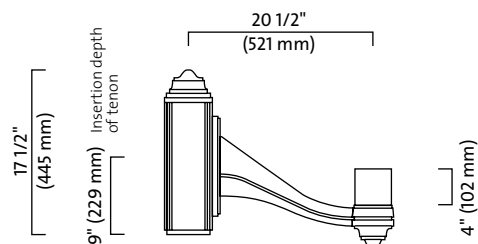

CRF

EPA: 1.34 sq.ft. Weight: 25.0 lbs. (11.3 kg)

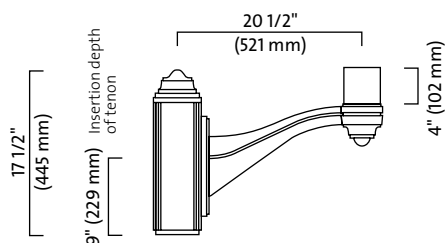

Specifications:

The YR / AR mounting arms feature a cast-aluminum curved arm and a decorative element welded to a cast-aluminum plate.

The luminaire adaptor will accept a luminaire equipped with Lumec's four-bolt mounting system.

The YR / AR plates are mechanically fastened using stainless steel hardware to a central pole adaptor slip-fitting 9" (229 mm) over a 4" (102 mm) O.D. pole or tenon.

Configurations

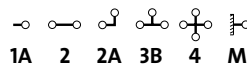

Mid-pole Configurations

> with pole option MPL



Specifications:

The CRD / CRF mounting arms feature a cast-aluminum curved arm mechanically assembled to a cast-aluminum plate.

The mounting arms are equipped with a 4" round (102 mm) by 4" high (102 mm) tenon for luminaire mounting.

The CRD / CRF plates are mechanically fastened by stainless steel hardware to a central pole adaptor slip-fitting 9" (229 mm) over a 4" (102 mm) O.D. pole or tenon.

Configurations

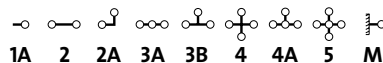

Mid-pole Configurations

> with pole option MPL

