

LEDALITE - TRUGROOVE SHAPES



by @ignify

TEST DATE: 25 Oct 2021 **CATALOG NO:** 29x5L93046LQS2

Lamp Type:	LED	Description:	SILK 70%UP 4600LM 930
No. of Lamps:	352		
Rated Lamp Lumens:	-1	Flux (lm), Efficiency (%):	9113 lm 100%
Input Watts:	120 VAC 72.5	Up/Dn Ratio, Efficacy (lm/W):	32% Down / 68% Up 125.7
CIE-IES Classification:	Semi-Indirect	Report:	LNG03094

CANDELA DISTRIBUTION						
	Flux					
	0	22.5	45	67.5	90	Lumens
0	1071	1071	1071	1071	1071	
5	1065	1066	1064	1066	1065	101
15	1016	1023	1017	1023	1016	288
25	929	940	930	940	929	431
35	814	827	815	827	814	513
45	679	689	678	689	679	527
55	516	534	524	534	516	470
65	355	367	355	367	355	355
75	183	192	183	192	183	199
85	41	46	42	46	41	52
90	0	0	0	0	0	
95	33	37	33	37	33	45
105	1255	974	428	974	1255	851
115	1608	1330	1157	1330	1608	1348
125	1497	1391	1247	1391	1497	1233
135	1355	1303	1217	1303	1355	1005
145	1242	1229	1200	1229	1242	769
155	1127	1135	1130	1135	1127	526
165	1058	1070	1070	1070	1058	304
175	1027	1035	1034	1035	1027	99
180	1025	1025	1025	1025	1025	

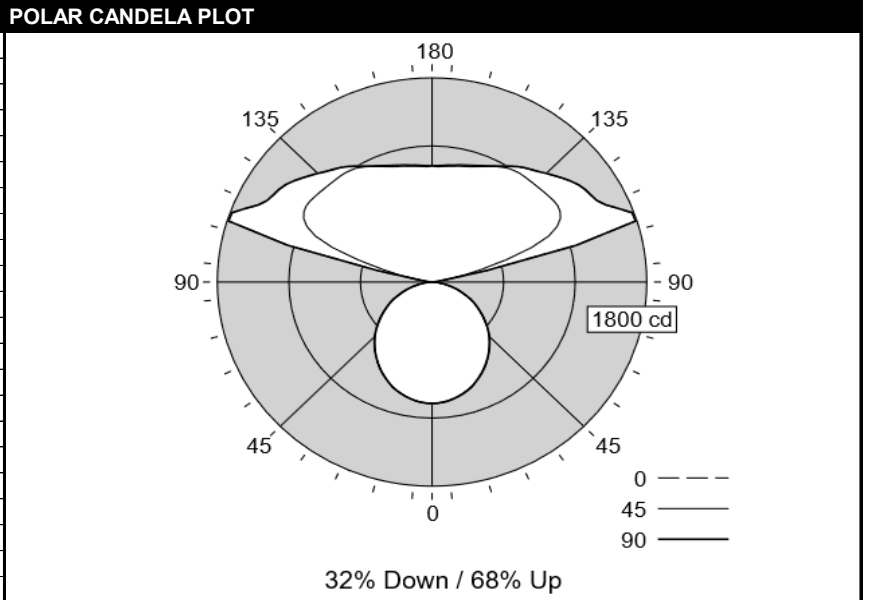

CHARACTERISTICS				COEFFICIENTS OF UTILIZATION (%)												
RP1	None			Pc---	80				70			50			0	
Direct: Peak Candela & Angle (0°)	1070.8	0.0		Pw---	70	50	30	10	70	50	30	50	30	10	0	
Direct: Peak Candela & Angle (90°)	1070.8	0.0		RCR												
Spacing Criteria (0°, 90°, 180°)	1.22	1.22	N/A	0	103	103	103	103	93	93	93	73	73	73	32	
Beam (H, V), Field (H, V)	107.7	107.7	160.7	160.7	1	94	90	86	82	84	81	78	64	62	60	27
Indirect: Peak Candela & Angle(°)	1790.2	107.5		2	85	78	72	67	76	70	65	56	53	50	23	
Indirect: Zenith Candela, Peak to Zenith	1025.2	1.75		3	78	68	61	56	70	62	56	49	45	42	19	
Luminous Width, Length, Height (ft)	2.25	2.25	0.00	4	71	60	53	47	64	55	48	44	39	35	16	
DLC, UGR (4H x 8H, 1.0H), MDER	N/A	12.6	0.505	5	65	54	46	40	58	49	42	39	34	30	14	
x, y, CCT, D _{uv}	0.4325	0.4005	3047	-0.0008	6	60	48	40	34	54	44	37	35	30	12	
CRI (R _a), R _g , G _a , C _g	93	57	99	93	7	55	43	35	30	49	39	32	32	27	11	
TM-30-18 R _f , R _g , R _{h1} , R _g , R _{h1}	91	90	100	-5%	8	51	39	32	26	46	36	29	29	24	10	
120V: P(W), I(A), THD(%), PF	72.5	0.607	7.8	0.994	9	47	36	28	23	43	32	26	26	21	9	
277V: P(W), I(A), THD(%), PF	72.3	0.275	9.4	0.948	10	44	32	25	21	40	30	23	24	19	8	
347V: P(W), I(A), THD(%), PF	72.6	0.216	7.4	0.966	*Based on a floor reflectance of 0.2											

ZONAL LUMENS (lm)			
Zone	Lumens	%Fixture	%Lamp
0-30	820	9.0%	9.0%
0-40	1333	14.6%	14.6%
0-60	2330	25.6%	25.6%
0-90	2936	32.2%	32.2%
90-130	3476	38.1%	38.1%
90-150	5250	57.6%	57.6%
90-180	6178	67.8%	67.8%
0-180	9113	100.0%	100.0%

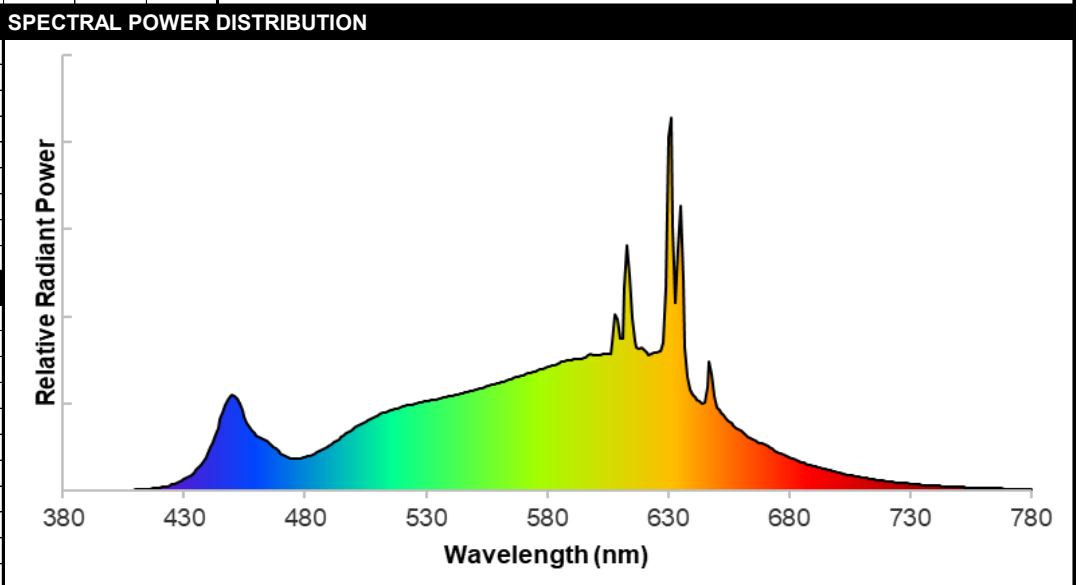

AVG LUMINANCE (cd/m ²)			
	0	45	90
0	2276	2276	2276
5	2271	2270	2271
15	2236	2238	2236
25	2179	2182	2179
35	2112	2115	2112
45	2040	2038	2040
55	1912	1940	1912
65	1785	1785	1785
75	1499	1501	1499
85	997	1032	997

Output of GLA Calculation Tool for CIE 13.3 CRI and Associated CRI-based Colour Rendition Properties

Test Number:	T20201106	Manufacturer:	Ledalite by Signify
Date:	27 Aug 2020	Model:	TruGroove Suspended

Correlated Colour Temperature (T_{cp}) in K	3047	CIE1931 chromaticity coordinate, x	0.4325
Distance to Blackbody Locus (D_{uv})	-0.0008	CIE1931 chromaticity coordinate, y	0.4005
General Colour Rendering Index (R_a)	93	CIE1976 chromaticity coordinate, u'	0.2492
Red Rendering Index (R_9)	57	CIE1976 chromaticity coordinate, v'	0.5193
Colour Gamut Index (G_a)	99		
Red Chroma Index (C_9)	93		

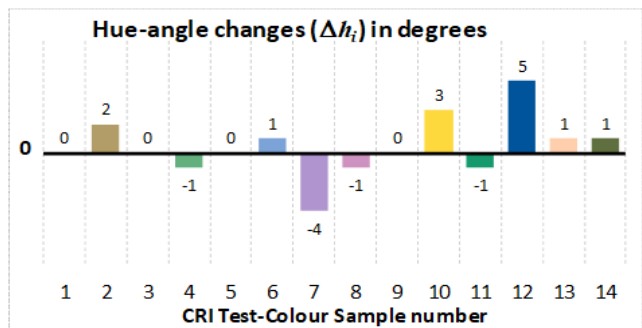
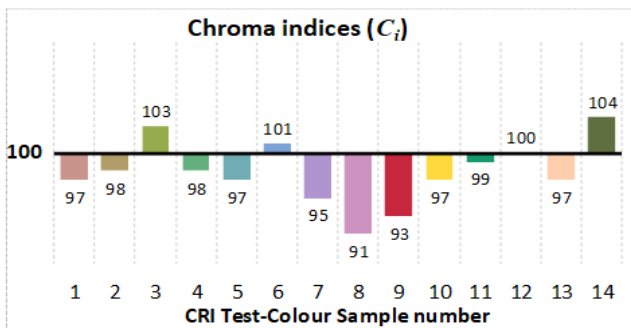
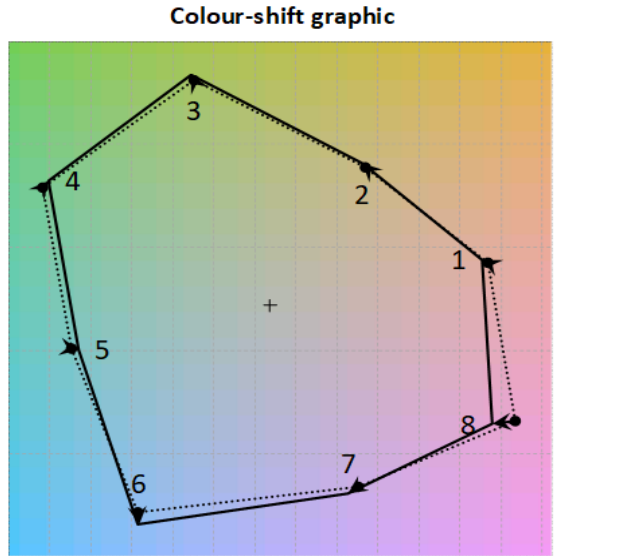
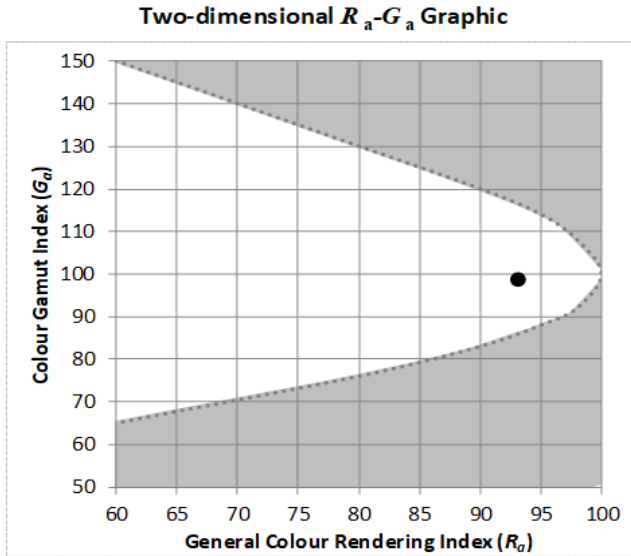
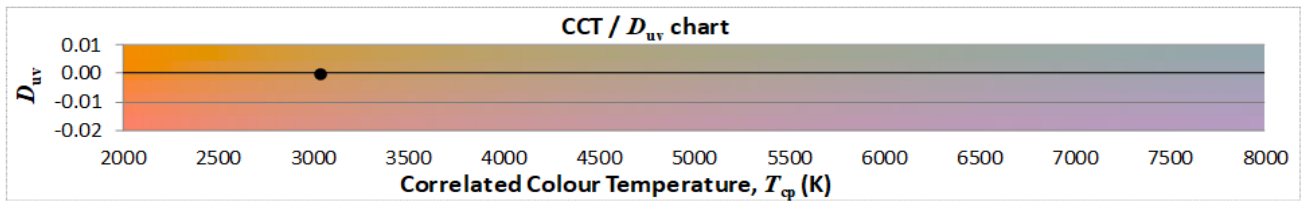
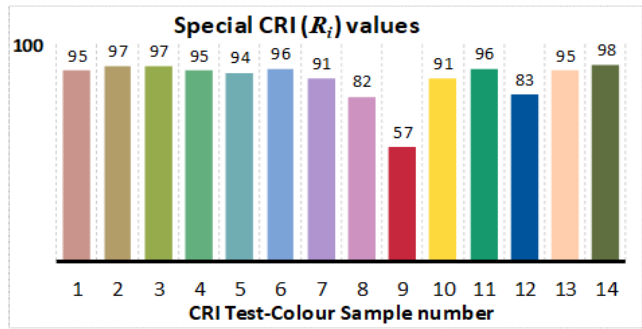
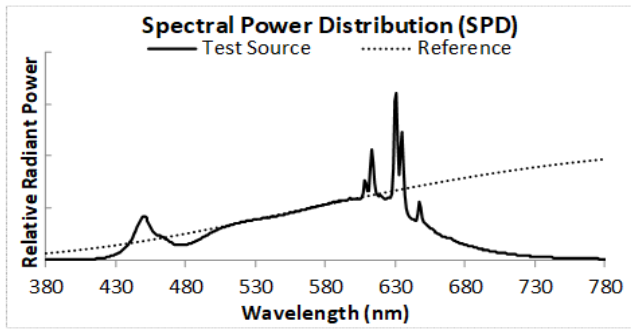

ANSI/IES TM-30-18 Color Rendition Report

Source: T20201106

Manufacturer: Ledalite by Signify

Date: 27 Aug 2020

Model: TruGroove Suspended

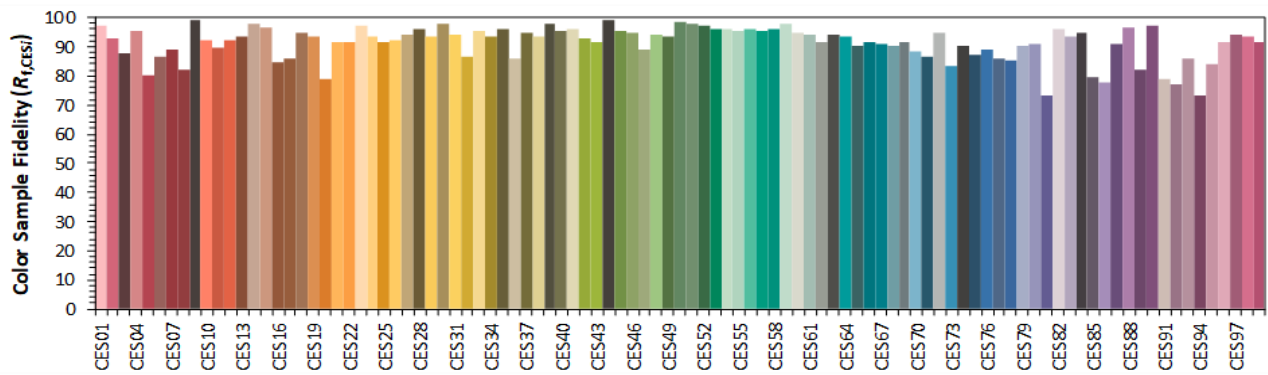
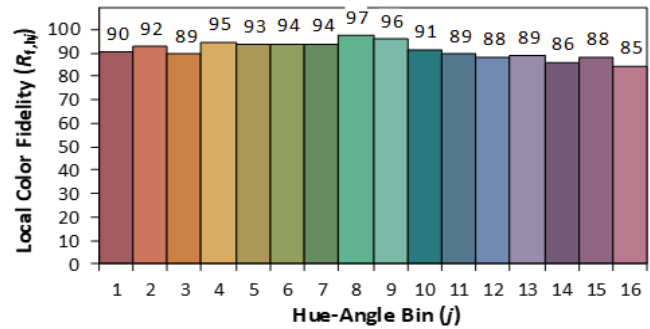
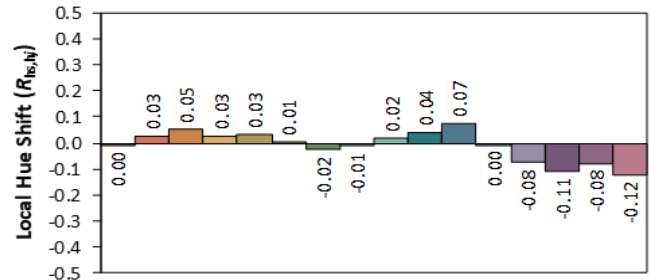
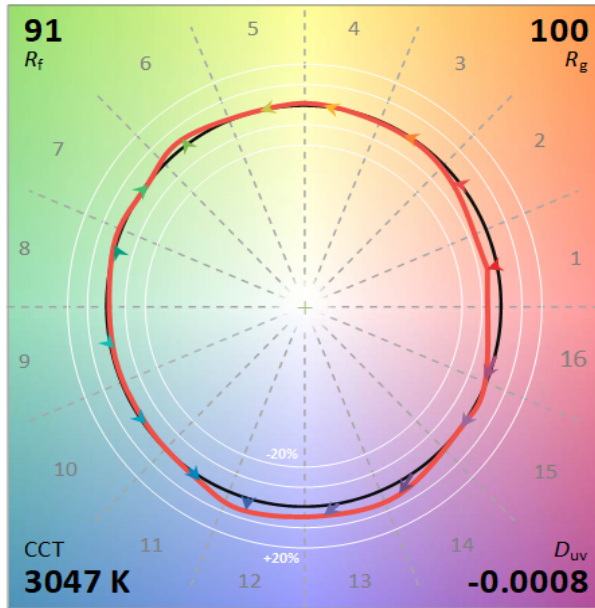
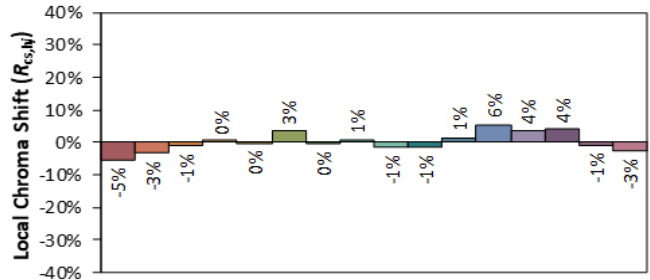
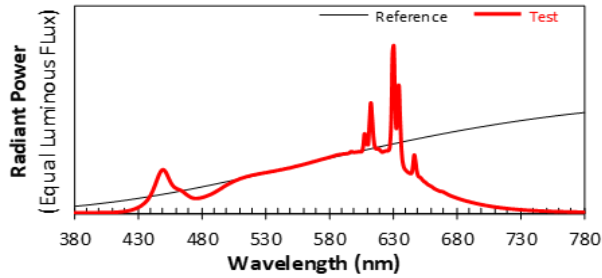

Notes: This is a recommended method for displaying ANSI/IES TM-30-18 information.

x 0.4325

y 0.4005

u' 0.2492

v' 0.5193

SPECTRAL POWER DISTRIBUTION

λ (nm)	SPD	λ (nm)	SPD	λ (nm)	SPD	λ (nm)	SPD	λ (nm)	SPD	λ (nm)	SPD	λ (nm)	SPD	λ (nm)	SPD	λ (nm)	SPD
380	0.00010	425	0.00340	470	0.02160	515	0.04600	560	0.06190	605	0.07820	650	0.04760	695	0.01220	740	0.00290
381	0.00020	426	0.00390	471	0.02070	516	0.04650	561	0.06220	606	0.07860	651	0.04590	696	0.01180	741	0.00280
382	0.00010	427	0.00440	472	0.01970	517	0.04680	562	0.06270	607	0.08480	652	0.04510	697	0.01150	742	0.00270
383	0.00010	428	0.00500	473	0.01920	518	0.04730	563	0.06320	608	0.10100	653	0.04310	698	0.01110	743	0.00260
384	0.00010	429	0.00570	474	0.01870	519	0.04770	564	0.06350	609	0.09830	654	0.04120	699	0.01070	744	0.00250
385	0.00010	430	0.00640	475	0.01840	520	0.04820	565	0.06400	610	0.08750	655	0.03990	700	0.01040	745	0.00250
386	0.00010	431	0.00720	476	0.01840	521	0.04850	566	0.06440	611	0.08720	656	0.03890	701	0.01010	746	0.00240
387	0.00010	432	0.00820	477	0.01850	522	0.04890	567	0.06490	612	0.11660	657	0.03730	702	0.00980	747	0.00230
388	0.00010	433	0.00910	478	0.01870	523	0.04900	568	0.06550	613	0.14100	658	0.03590	703	0.00940	748	0.00220
389	0.00000	434	0.01040	479	0.01890	524	0.04950	569	0.06580	614	0.12350	659	0.03510	704	0.00920	749	0.00220
390	0.00010	435	0.01160	480	0.01930	525	0.04980	570	0.06640	615	0.09880	660	0.03430	705	0.00890	750	0.00210
391	0.00010	436	0.01310	481	0.01970	526	0.05010	571	0.06670	616	0.08610	661	0.03330	706	0.00860	751	0.00200
392	0.00010	437	0.01490	482	0.02020	527	0.05050	572	0.06720	617	0.08210	662	0.03200	707	0.00840	752	0.00190
393	0.00010	438	0.01670	483	0.02070	528	0.05060	573	0.06770	618	0.08180	663	0.03090	708	0.00810	753	0.00190
394	0.00010	439	0.01900	484	0.02120	529	0.05100	574	0.06830	619	0.08230	664	0.03000	709	0.00780	754	0.00180
395	0.00010	440	0.02170	485	0.02200	530	0.05140	575	0.06850	620	0.08040	665	0.02920	710	0.00760	755	0.00180
396	0.00010	441	0.02480	486	0.02250	531	0.05140	576	0.06920	621	0.07900	666	0.02850	711	0.00730	756	0.00170
397	0.00010	442	0.02830	487	0.02320	532	0.05190	577	0.06950	622	0.07760	667	0.02780	712	0.00710	757	0.00170
398	0.00010	443	0.03230	488	0.02390	533	0.05220	578	0.06990	623	0.07830	668	0.02730	713	0.00690	758	0.00160
399	0.00010	444	0.03630	489	0.02480	534	0.05240	579	0.07040	624	0.07890	669	0.02720	714	0.00670	759	0.00160
400	0.00010	445	0.04090	490	0.02570	535	0.05290	580	0.07090	625	0.07940	670	0.02680	715	0.00640	760	0.00150
401	0.00020	446	0.04490	491	0.02650	536	0.05310	581	0.07120	626	0.07960	671	0.02560	716	0.00620	761	0.00150
402	0.00020	447	0.04910	492	0.02760	537	0.05340	582	0.07190	627	0.07970	672	0.02480	717	0.00600	762	0.00140
403	0.00020	448	0.05230	493	0.02860	538	0.05370	583	0.07220	628	0.08480	673	0.02390	718	0.00590	763	0.00140
404	0.00020	449	0.05450	494	0.02950	539	0.05410	584	0.07280	629	0.11660	674	0.02300	719	0.00570	764	0.00130
405	0.00030	450	0.05530	495	0.03060	540	0.05430	585	0.07330	630	0.20300	675	0.02240	720	0.00550	765	0.00130
406	0.00030	451	0.05450	496	0.03150	541	0.05460	586	0.07380	631	0.21390	676	0.02160	721	0.00530	766	0.00130
407	0.00030	452	0.05270	497	0.03270	542	0.05510	587	0.07440	632	0.15070	677	0.02100	722	0.00510	767	0.00130
408	0.00030	453	0.04970	498	0.03370	543	0.05530	588	0.07450	633	0.10790	678	0.02040	723	0.00500	768	0.00120
409	0.00040	454	0.04600	499	0.03460	544	0.05570	589	0.07480	634	0.13820	679	0.01980	724	0.00480	769	0.00120
410	0.00050	455	0.04250	500	0.03560	545	0.05590	590	0.07490	635	0.16360	680	0.01920	725	0.00470	770	0.00110
411	0.00050	456	0.03910	501	0.03650	546	0.05640	591	0.07530	636	0.12070	681	0.01860	726	0.00450	771	0.00100
412	0.00060	457	0.03640	502	0.03750	547	0.05670	592	0.07550	637	0.08220	682	0.01810	727	0.00430	772	0.00110
413	0.00070	458	0.03440	503	0.03810	548	0.05720	593	0.07560	638	0.06520	683	0.01750	728	0.00420	773	0.00100
414	0.00080	459	0.03270	504	0.03900	549	0.05730	594	0.07580	639	0.05830	684	0.01700	729	0.00410	774	0.00100
415	0.00090	460	0.03170	505	0.03980	550	0.05770	595	0.07590	640	0.05530	685	0.01650	730	0.00400	775	0.00100
416	0.00100	461	0.03070	506	0.04060	551	0.05810	596	0.07650	641	0.05350	686	0.01600	731	0.00380	776	0.00090
417	0.00120	462	0.03020	507	0.04130	552	0.05860	597	0.07800	642	0.05200	687	0.01560	732	0.00370	777	0.00090
418	0.00140	463	0.02950	508	0.04190	553	0.05900	598	0.07860	643	0.05110	688	0.01500	733	0.00360	778	0.00090
419	0.00150	464	0.02880	509	0.04270	554	0.05950	599	0.07770	644	0.05030	689	0.01470	734	0.00350	779	0.00090
420	0.00180	465	0.02780	510	0.04330	555	0.05980	600	0.07750	645	0.05050	690	0.01420	735	0.00330	780	0.00090
421	0.00200	466	0.02670	511	0.04390	556	0.06010	601	0.07770	646	0.05910	691	0.01380	736	0.00330		
422	0.00230	467	0.02530	512	0.04450	557	0.06060	602	0.07770	647	0.07410	692	0.01340	737	0.00320		
423	0.00260	468	0.02390	513	0.04500	558	0.06090	603	0.07820	648	0.06670	693	0.01300	738	0.00310		
424	0.00300	469	0.02280	514	0.04550	559	0.06140	604	0.07830	649	0.05430	694	0.01260	739	0.00300		

UNIFIED GLARE RATING

Reflectances											
Ceiling Cavity	70	70	50	50	30	70	70	50	50	30	
Walls	50	30	50	30	30	50	30	50	30	30	
Floor Cavity	20	20	20	20	20	20	20	20	20	20	
Room Size	UGR Viewed Crosswise					UGR Viewed Endwise					
X=2H	Y=2H	8.8	9.5	9.9	10.6	12.1	8.8	9.5	9.9	10.6	12.1
	3H	10.5	11.1	11.6	12.2	13.7	10.5	11.1	11.6	12.2	13.7
	4H	11.1	11.7	12.2	12.8	14.3	11.1	11.7	12.2	12.8	14.3
	6H	11.4	12.0	12.6	13.1	14.7	11.4	12.0	12.6	13.1	14.7
	8H	11.6	12.1	12.7	13.2	14.7	11.6	12.1	12.7	13.2	14.7
	12H	11.6	12.1	12.7	13.2	14.8	11.6	12.1	12.7	13.2	14.8
4H	2H	9.3	9.9	10.4	11.0	12.5	9.3	9.9	10.4	11.0	12.5
	3H	11.2	11.7	12.3	12.8	14.4	11.2	11.7	12.3	12.8	14.4
	4H	11.9	12.4	13.1	13.5	15.1	11.9	12.4	13.1	13.5	15.1
	6H	12.4	12.8	13.6	14.0	15.5	12.4	12.8	13.6	14.0	15.5
	8H	12.6	13.0	13.7	14.1	15.7	12.6	13.0	13.7	14.1	15.7
	12H	12.7	13.0	13.8	14.1	15.7	12.7	13.0	13.8	14.1	15.7
8H	4H	12.1	12.5	13.3	13.6	15.2	12.1	12.5	13.3	13.6	15.2
	6H	12.8	13.1	14.0	14.3	15.8	12.8	13.1	14.0	14.3	15.8
	8H	13.0	13.3	14.2	14.4	16.0	13.0	13.3	14.2	14.4	16.0
	12H	13.1	13.4	14.3	14.5	16.2	13.1	13.4	14.3	14.5	16.2
12H	4H	12.1	12.5	13.3	13.6	15.2	12.1	12.5	13.3	13.6	15.2
	6H	12.8	13.1	14.0	14.2	15.8	12.8	13.1	14.0	14.2	15.8
	8H	13.1	13.3	14.2	14.5	16.1	13.1	13.3	14.2	14.5	16.1

The UGR values have been calculated according to CIE Publ. 117.

Spacing-to-Height-Ratio = 1.00.

The highlighted value refers to the UGR value which the luminaire would have in a reference situation with room dimensions of 4H/8H and degrees of reflectance of 20% for the floor, 50% for the walls and 70% for the ceiling, as recommended by DLC.

The UGR value may vary depending on application specific parameters.