

LEDALITE - TRUGROOVE SHAPES

TEST DATE: 25 Oct 2021 **CATALOG NO:** 29x5L93535LQS2

Lamp Type:	LED	Description:	SILK 60%UP 3500LM 935
No. of Lamps:	352		
Rated Lamp Lumens:	-1	Flux (lm), Efficiency (%):	7042 lm 100%
Input Watts:	120 VAC 55.7	Up/Dn Ratio, Efficacy (lm/W):	43% Down / 57% Up 126.4
CIE-IES Classification:	Direct-Indirect	Report:	LNG03075

CANDELA DISTRIBUTION						
	Flux					
	0	22.5	45	67.5	90	Lumens
0	1102	1102	1102	1102	1102	
5	1096	1097	1095	1097	1096	104
15	1046	1053	1047	1053	1046	296
25	956	967	957	967	956	444
35	838	851	839	851	838	528
45	699	709	698	709	699	542
55	531	550	539	550	531	484
65	365	378	365	378	365	365
75	188	197	188	197	188	205
85	42	47	44	47	42	53
90	0	0	0	0	0	
95	21	24	21	24	21	29
105	817	634	278	634	817	554
115	1046	866	753	866	1046	877
125	974	905	811	905	974	802
135	882	848	792	848	882	654
145	809	800	781	800	809	500
155	733	739	735	739	733	342
165	688	696	696	696	688	198
175	668	673	673	673	668	64
180	667	667	667	667	667	

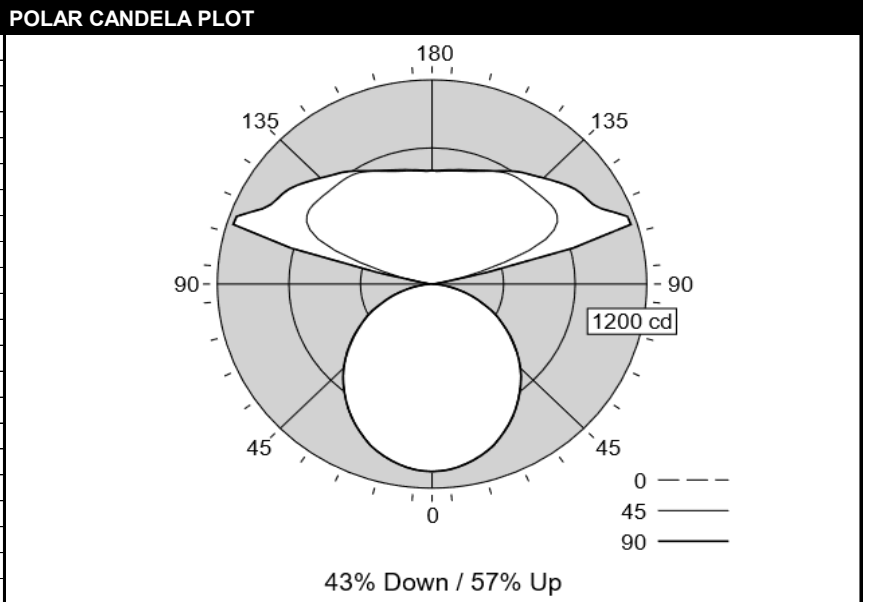

CHARACTERISTICS				COEFFICIENTS OF UTILIZATION (%)												
RP1	None			Pc---	80				70			50			0	
Direct: Peak Candela & Angle (0°)	1102.0	0.0		Pw---	70	50	30	10	70	50	30	50	30	10	0	
Direct: Peak Candela & Angle (90°)	1102.0	0.0		RCR												
Spacing Criteria (0°, 90°, 180°)	1.22	1.22	N/A	0	105	105	105	105	96	96	96	79	79	79	43	
Beam (H, V), Field (H, V)	107.6	107.6	160.7	160.7	1	96	92	88	84	88	84	81	69	67	65	36
Indirect: Peak Candela & Angle(°)	1165.1	107.5			2	87	80	74	69	80	73	68	61	57	54	30
Indirect: Zenith Candela, Peak to Zenith	667.2	1.75			3	80	70	63	57	72	64	58	53	49	45	25
Luminous Width, Length, Height (ft)	2.25	2.25	0.00		4	73	62	54	48	66	57	50	47	42	38	22
DLC, UGR (4H x 8H, 1.0H), MDER	N/A	13.9	0.578		5	67	55	47	41	61	51	44	42	37	33	19
x, y, CCT, D _{uv}	0.4070	0.3906	3462	-0.0004	6	61	49	41	36	56	45	38	38	33	29	16
CRI (R _a), R _g , G _a , C _g	93	59	99	93	7	57	45	37	31	52	41	34	34	29	25	14
TM-30-18 R _f , R _{h1} , R _g , R _{sb1}	91	90	99	-6%	8	53	40	33	27	48	37	30	31	26	22	13
120V: P(W), I(A), THD(%), PF	55.7	0.467	9.2	0.993	9	49	37	29	24	45	34	27	29	23	20	12
277V: P(W), I(A), THD(%), PF	55.5	0.213	9.4	0.940	10	46	34	26	22	42	31	25	26	21	18	11
347V: P(W), I(A), THD(%), PF	56.8	0.172	8.2	0.954	*Based on a floor reflectance of 0.2											

ZONAL LUMENS (lm)			
Zone	Lumens	%Fixture	%Lamp
0-30	844	12.0%	12.0%
0-40	1372	19.5%	19.5%
0-60	2398	34.1%	34.1%
0-90	3021	42.9%	42.9%
90-130	2263	32.1%	32.1%
90-150	3417	48.5%	48.5%
90-180	4021	57.1%	57.1%
0-180	7042	100.0%	100.0%

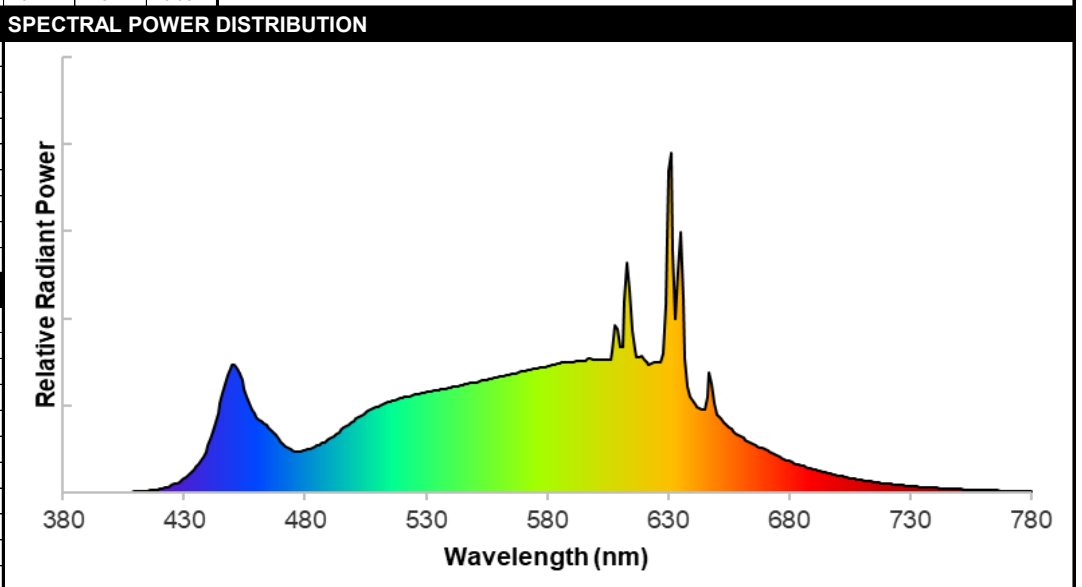

AVG LUMINANCE (cd/m ²)			
	0	45	90
0	2342	2342	2342
5	2338	2336	2338
15	2301	2304	2301
25	2242	2245	2242
35	2173	2177	2173
45	2100	2097	2100
55	1968	1997	1968
65	1837	1837	1837
75	1543	1546	1543
85	1027	1061	1027

Output of GLA Calculation Tool for CIE 13.3 CRI and Associated CRI-based Colour Rendition Properties

Test Number:	T20201107	Manufacturer:	Ledalite by Signify
Date:	27 Aug 2020	Model:	TruGroove Suspended

Correlated Colour Temperature (T_{cp}) in K	3462	CIE1931 chromaticity coordinate, x	0.4070
Distance to Blackbody Locus (D_{uv})	-0.0004	CIE1931 chromaticity coordinate, y	0.3906
General Colour Rendering Index (R_a)	93	CIE1976 chromaticity coordinate, u'	0.2369
Red Rendering Index (R_9)	59	CIE1976 chromaticity coordinate, v'	0.5115
Colour Gamut Index (G_a)	99		
Red Chroma Index (C_9)	93		

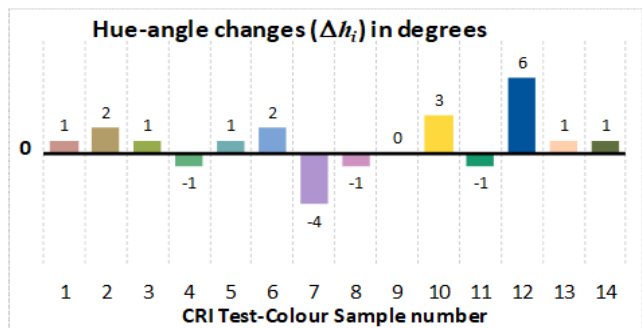
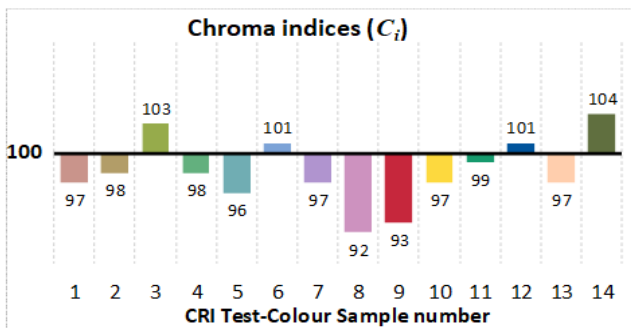
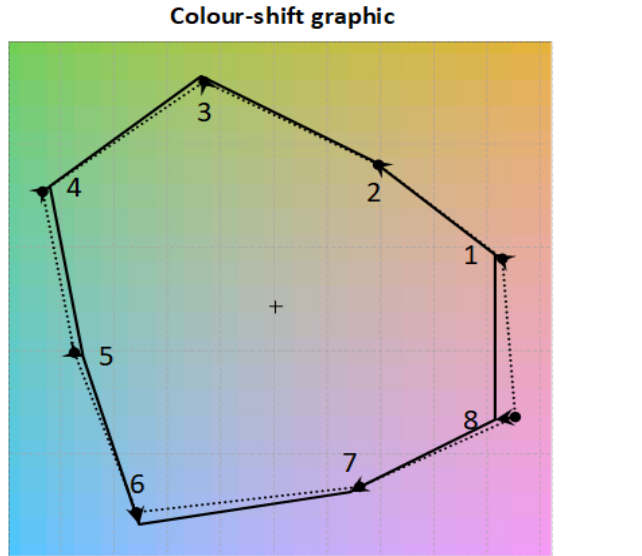
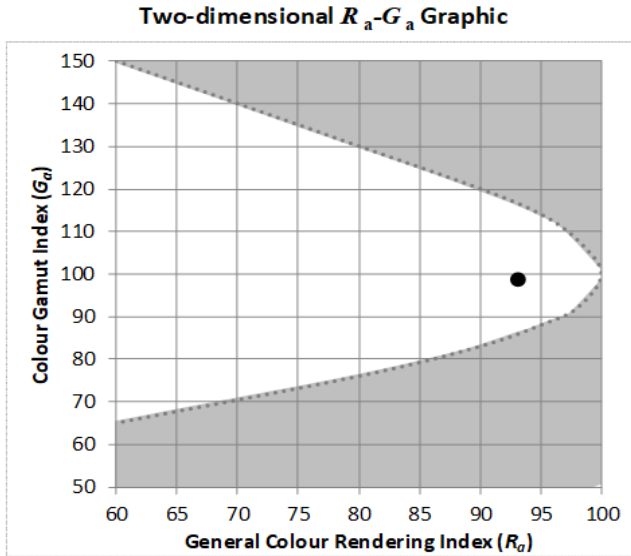
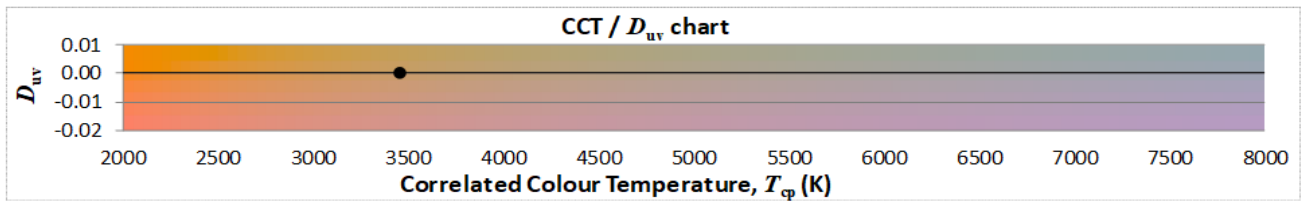
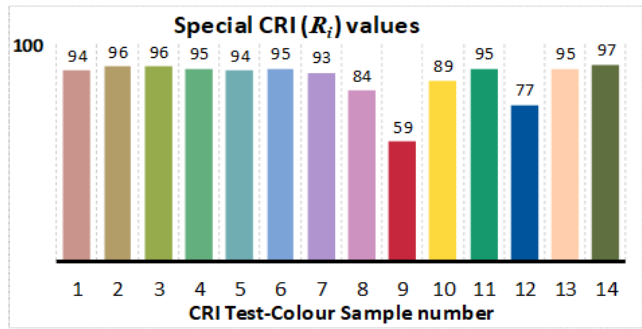
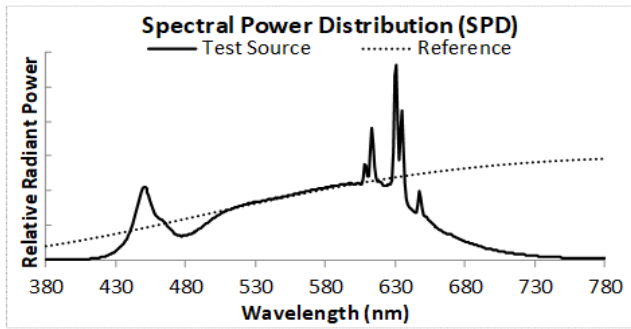

ANSI/IES TM-30-18 Color Rendition Report

Source: T20201107

Manufacturer: Ledalite by Signify

Date: 27 Aug 2020

Model: TruGroove Suspended

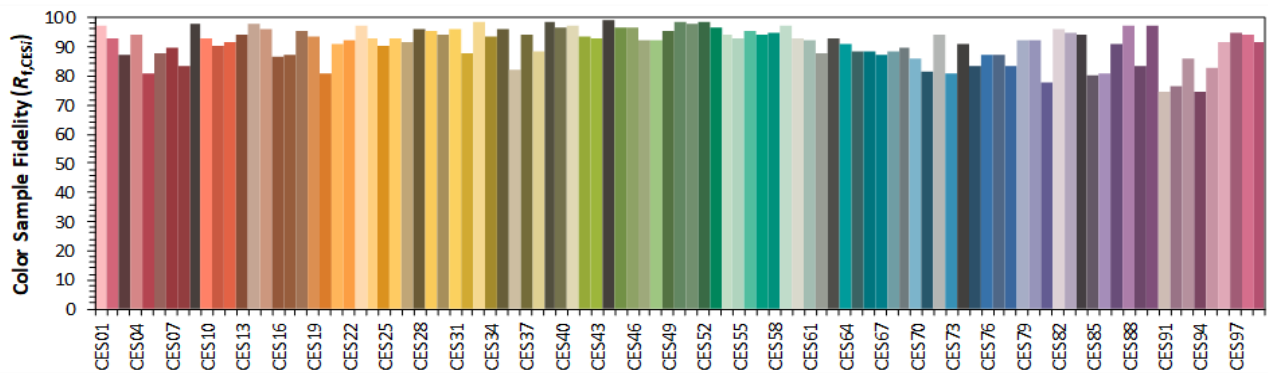
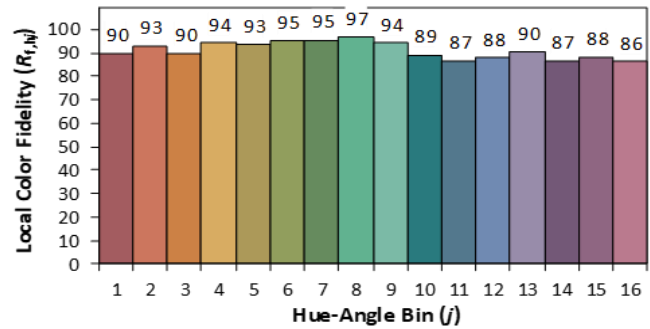
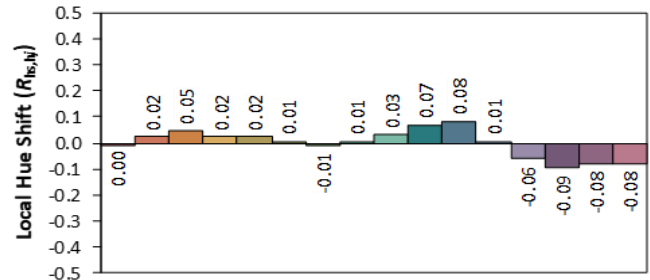
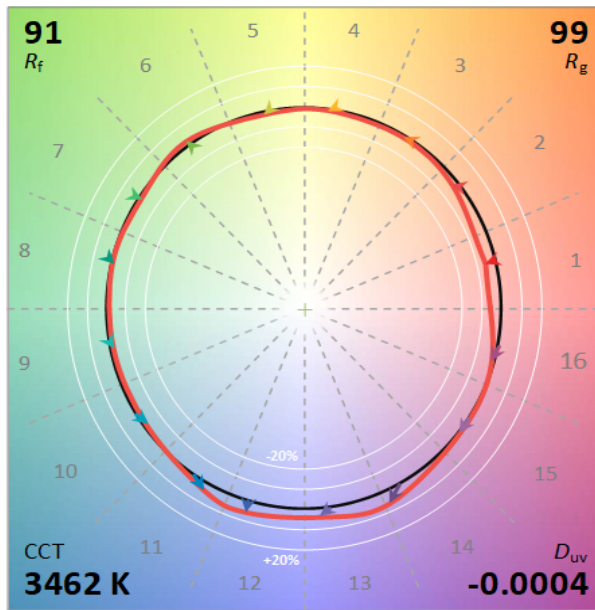
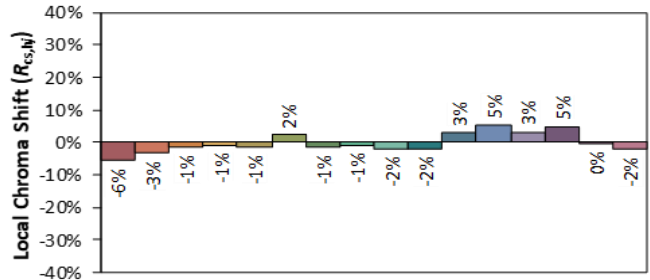
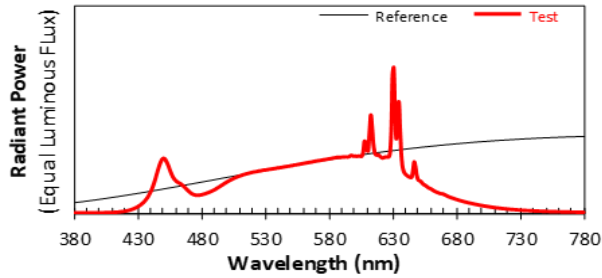

Notes: This is a recommended method for displaying ANSI/IES TM-30-18 information.

x 0.4070

y 0.3906

u' 0.2369

v' 0.5115

SPECTRAL POWER DISTRIBUTION

λ (nm)	SPD	λ (nm)	SPD	λ (nm)	SPD	λ (nm)	SPD	λ (nm)	SPD	λ (nm)	SPD	λ (nm)	SPD	λ (nm)	SPD	λ (nm)	SPD
380	0.00010	425	0.00420	470	0.02950	515	0.05240	560	0.06640	605	0.07610	650	0.04490	695	0.01150	740	0.00270
381	0.00010	426	0.00480	471	0.02790	516	0.05270	561	0.06670	606	0.07630	651	0.04340	696	0.01120	741	0.00270
382	0.00010	427	0.00550	472	0.02640	517	0.05320	562	0.06710	607	0.08170	652	0.04260	697	0.01090	742	0.00250
383	0.00010	428	0.00630	473	0.02540	518	0.05360	563	0.06730	608	0.09630	653	0.04070	698	0.01050	743	0.00240
384	0.00010	429	0.00710	474	0.02460	519	0.05410	564	0.06770	609	0.09390	654	0.03880	699	0.01020	744	0.00240
385	0.00010	430	0.00800	475	0.02410	520	0.05460	565	0.06800	610	0.08380	655	0.03770	700	0.00990	745	0.00230
386	0.00010	431	0.00910	476	0.02370	521	0.05500	566	0.06820	611	0.08340	656	0.03670	701	0.00960	746	0.00230
387	0.00010	432	0.01020	477	0.02360	522	0.05520	567	0.06860	612	0.10960	657	0.03540	702	0.00930	747	0.00220
388	0.00020	433	0.01150	478	0.02370	523	0.05540	568	0.06910	613	0.13180	658	0.03390	703	0.00900	748	0.00210
389	0.00010	434	0.01300	479	0.02390	524	0.05590	569	0.06930	614	0.11580	659	0.03310	704	0.00870	749	0.00200
390	0.00010	435	0.01450	480	0.02420	525	0.05630	570	0.06980	615	0.09340	660	0.03240	705	0.00840	750	0.00200
391	0.00010	436	0.01650	481	0.02470	526	0.05640	571	0.06990	616	0.08180	661	0.03140	706	0.00820	751	0.00190
392	0.00010	437	0.01860	482	0.02520	527	0.05670	572	0.07020	617	0.07810	662	0.03020	707	0.00790	752	0.00190
393	0.00010	438	0.02090	483	0.02560	528	0.05710	573	0.07040	618	0.07780	663	0.02920	708	0.00760	753	0.00180
394	0.00010	439	0.02380	484	0.02620	529	0.05750	574	0.07080	619	0.07820	664	0.02840	709	0.00740	754	0.00180
395	0.00010	440	0.02710	485	0.02690	530	0.05760	575	0.07110	620	0.07640	665	0.02760	710	0.00720	755	0.00170
396	0.00010	441	0.03080	486	0.02760	531	0.05780	576	0.07150	621	0.07490	666	0.02700	711	0.00700	756	0.00170
397	0.00020	442	0.03520	487	0.02830	532	0.05810	577	0.07170	622	0.07360	667	0.02630	712	0.00670	757	0.00160
398	0.00010	443	0.04020	488	0.02890	533	0.05850	578	0.07200	623	0.07400	668	0.02590	713	0.00650	758	0.00160
399	0.00020	444	0.04540	489	0.02980	534	0.05870	579	0.07210	624	0.07490	669	0.02570	714	0.00630	759	0.00150
400	0.00010	445	0.05150	490	0.03080	535	0.05890	580	0.07250	625	0.07500	670	0.02520	715	0.00610	760	0.00140
401	0.00020	446	0.05730	491	0.03160	536	0.05930	581	0.07270	626	0.07520	671	0.02420	716	0.00590	761	0.00140
402	0.00020	447	0.06270	492	0.03270	537	0.05960	582	0.07320	627	0.07510	672	0.02350	717	0.00570	762	0.00140
403	0.00020	448	0.06760	493	0.03370	538	0.05960	583	0.07340	628	0.07960	673	0.02260	718	0.00560	763	0.00130
404	0.00030	449	0.07130	494	0.03480	539	0.06020	584	0.07390	629	0.10770	674	0.02180	719	0.00540	764	0.00130
405	0.00030	450	0.07330	495	0.03600	540	0.06050	585	0.07410	630	0.18510	675	0.02120	720	0.00520	765	0.00120
406	0.00030	451	0.07330	496	0.03710	541	0.06060	586	0.07450	631	0.19530	676	0.02050	721	0.00500	766	0.00120
407	0.00040	452	0.07150	497	0.03810	542	0.06100	587	0.07470	632	0.13860	677	0.01990	722	0.00480	767	0.00110
408	0.00040	453	0.06810	498	0.03930	543	0.06110	588	0.07480	633	0.09950	678	0.01930	723	0.00470	768	0.00120
409	0.00050	454	0.06430	499	0.04030	544	0.06150	589	0.07480	634	0.12660	679	0.01870	724	0.00460	769	0.00110
410	0.00050	455	0.05950	500	0.04140	545	0.06180	590	0.07490	635	0.14960	680	0.01820	725	0.00440	770	0.00110
411	0.00060	456	0.05510	501	0.04240	546	0.06210	591	0.07510	636	0.11130	681	0.01770	726	0.00430	771	0.00100
412	0.00070	457	0.05110	502	0.04330	547	0.06230	592	0.07520	637	0.07670	682	0.01710	727	0.00420	772	0.00100
413	0.00080	458	0.04770	503	0.04410	548	0.06280	593	0.07530	638	0.06120	683	0.01660	728	0.00400	773	0.00100
414	0.00100	459	0.04520	504	0.04510	549	0.06290	594	0.07530	639	0.05520	684	0.01610	729	0.00390	774	0.00100
415	0.00110	460	0.04340	505	0.04590	550	0.06330	595	0.07520	640	0.05250	685	0.01560	730	0.00380	775	0.00090
416	0.00130	461	0.04190	506	0.04680	551	0.06340	596	0.07560	641	0.05070	686	0.01520	731	0.00360	776	0.00090
417	0.00150	462	0.04080	507	0.04740	552	0.06380	597	0.07690	642	0.04940	687	0.01470	732	0.00350	777	0.00090
418	0.00170	463	0.03990	508	0.04820	553	0.06440	598	0.07730	643	0.04850	688	0.01430	733	0.00340	778	0.00090
419	0.00190	464	0.03900	509	0.04890	554	0.06440	599	0.07640	644	0.04780	689	0.01390	734	0.00330	779	0.00080
420	0.00220	465	0.03740	510	0.04950	555	0.06490	600	0.07610	645	0.04760	690	0.01340	735	0.00320	780	0.00080
421	0.00250	466	0.03610	511	0.05010	556	0.06510	601	0.07630	646	0.05540	691	0.01310	736	0.00310		
422	0.00290	467	0.03440	512	0.05060	557	0.06530	602	0.07600	647	0.06860	692	0.01270	737	0.00300		
423	0.00320	468	0.03270	513	0.05140	558	0.06580	603	0.07650	648	0.06220	693	0.01230	738	0.00290		
424	0.00370	469	0.03100	514	0.05180	559	0.06610	604	0.07640	649	0.05100	694	0.01190	739	0.00280		

UNIFIED GLARE RATING

Reflectances											
Ceiling Cavity	70	70	50	50	30	70	70	50	50	30	
Walls	50	30	50	30	30	50	30	50	30	30	
Floor Cavity	20	20	20	20	20	20	20	20	20	20	
Room Size	UGR Viewed Crosswise					UGR Viewed Endwise					
X=2H	Y=2H	10.1	10.9	11.1	11.9	13.3	10.1	10.9	11.1	11.9	13.3
	3H	11.8	12.5	12.8	13.6	14.9	11.8	12.5	12.8	13.6	14.9
	4H	12.4	13.1	13.4	14.1	15.5	12.4	13.1	13.4	14.1	15.5
	6H	12.8	13.4	13.8	14.5	15.9	12.8	13.4	13.8	14.5	15.9
	8H	12.9	13.5	13.9	14.6	16.0	12.9	13.5	13.9	14.6	16.0
	12H	12.9	13.5	14.0	14.6	16.0	12.9	13.5	14.0	14.6	16.0
4H	2H	10.6	11.3	11.7	12.3	13.7	10.6	11.3	11.7	12.3	13.7
	3H	12.5	13.1	13.6	14.2	15.6	12.5	13.1	13.6	14.2	15.6
	4H	13.3	13.8	14.3	14.8	16.3	13.3	13.8	14.3	14.8	16.3
	6H	13.8	14.2	14.9	15.3	16.7	13.8	14.2	14.9	15.3	16.7
	8H	13.9	14.4	15.0	15.4	16.9	13.9	14.4	15.0	15.4	16.9
	12H	14.0	14.4	15.1	15.5	16.9	14.0	14.4	15.1	15.5	16.9
8H	4H	13.5	13.9	14.6	15.0	16.4	13.5	13.9	14.6	15.0	16.4
	6H	14.1	14.5	15.2	15.6	17.0	14.1	14.5	15.2	15.6	17.0
	8H	14.4	14.7	15.5	15.8	17.2	14.4	14.7	15.5	15.8	17.2
	12H	14.5	14.8	15.6	15.9	17.4	14.5	14.8	15.6	15.9	17.4
12H	4H	13.5	13.9	14.6	14.9	16.4	13.5	13.9	14.6	14.9	16.4
	6H	14.2	14.5	15.3	15.6	17.0	14.2	14.5	15.3	15.6	17.0
	8H	14.4	14.7	15.5	15.8	17.3	14.4	14.7	15.5	15.8	17.3

The UGR values have been calculated according to CIE Publ. 117.

Spacing-to-Height-Ratio = 1.00.

The highlighted value refers to the UGR value which the luminaire would have in a reference situation with room dimensions of 4H/8H and degrees of reflectance of 20% for the floor, 50% for the walls and 70% for the ceiling, as recommended by DLC.

The UGR value may vary depending on application specific parameters.