



Gardco 101 LED wall sconces feature a low-profile design that provides wide flexibility in high performance exterior wall illumination. Full cutoff performance, usable illumination patterns, and powerful wattages combine into a compact and architecturally pleasing design. 101L sconces are available in Type 2, 3, and 4 distributions, and provide output of up to 9500 lumens. Energy saving control options increase energy savings and offer California Title 24 compliance. Emergency Battery Backup option available for path of egress.

Project: _____
 Location: _____
 Cat.No: _____
 Type: _____
 Lamps: _____ Qty: _____
 Notes: _____

Ordering guide

example: 101L-32L-700-NW-G1-3-120-IMRI2-BZ

Prefix	Number of LEDs	Drive Current	LED Color - Generation	Distribution	Emergency	Voltage	Options		
							Controls	Electrical	Finish
101L									
101L 101L LED Wall Sconce	16L 16 LEDs (1 module)	530 530mA 650 650mA ¹ 700 700mA 1000 1000mA 1200 1200mA	CW-G1 Cool White 5000K, 70 CRI Generation 1 NW-G1 Neutral White 4000K, 70 CRI Generation 1 WW-G1 Warm White 3000K, 70 CRI Generation 1	2 Type 2 3 Type 3 4 Type 4	EBPC Emergency Battery Pack Cold Weather ^{3,4,6,12} Leave blank to omit an emergency option	UNV 120-277V HVU 347-480V 120 120V 208 208V 240 240V 277 277V 347 347V 480 480V	DD 0-10V Dimming Driver ^{5,6} DCC Dual Circuit Control ^{6,7,8} DynaDimmer: Automatic Profile Dimming CS50 Safety 50% Dimming (7 hours) ^{7,9,10} CM50 Median 50% Dimming (8 hours) ^{7,9,10} CE50 Economy 50% Dimming (9 hours) ^{7,9,10} DA50 All Night 50% Dimming ^{7,9,10} Photoelectric/Receptacle systems (Twist Lock Receptacle) PCB Photocontrol Button ^{5,9,10,12} TLRD5 Twist Lock Receptacle 5-Pin ¹³ TLRD7 Twist Lock Receptacle 7-Pin ¹³ TLRPC Twist Lock Receptacle w/ Photocell ^{11,12,16} Infrared Motion Response systems IMRI2 Integral with #2 lens ^{9,12,14} IMRI3 Integral with #4 lens ^{9,12,14} Wireless system LLC2 Integral module with #2 lens ^{5,7,9,15} LLC3 Integral module with #3 lens ^{5,7,9,15}	Fusing F1 Single (120, 277, 347VAC) ¹² F2 Double (208, 240, 480VAC) ¹² F3 Canadian Double Pull (208, 240, 480VAC) ¹²	Textured BK Black WH White BZ Bronze DGY Dark Gray MGY Medium Gray Customer specified RAL Specify optional color or RAL (ex: OC-LGP or OC-RAL7024) CC Custom color (Must supply color chip for required factory quote)

- 650mA only available with Emergency Battery Pack Cold Rated (EBPC) option
- 32L rated for 30°C at 1000mA
- Available for use with 16L and 32L in 530mA or 650mA only. Rated for -20°C to 35°C.
- Available in 120 or 277V only.
- Not available with Dual Circuit Control (DCC) option.
- EBPC is not available with DCC.
- Not available with Dimming Driver (DD) option.
- Available in 32L with 530mA. Consult technical support center for use with photocell and CS/CM/CE/DA.
- Available in 120-277V (UNV) only.
- Not available with LLC, TLR and DCC.
- Not available with 480V.
- Must specify input voltage.
- TLRD5/7 option not available with LLC, PCB, DCC. Works with 3 or 5 pin NEMA photocell dimming. Dimming will not be connected to TLR if ordering with DD, CS/CM/CE/DA and IMRI.
- Not available with DD, DCC or LLC.
- LLC2/3 Not available with TLR, PCB, IMRI, CS/CM/CE/DA. Ships with WS accessory attached to wireless module. Not for use with LLCR accessory.
- Not available with PCB, TLRD5/7, DCC, LLC.

101L Sconce LED

Wall Mount

Luminaire Accessories (order separately)

Mounting accessories

Wall Mount

WS Wall Mounted Box for Surface Conduit

System accessories

Wireless system remote mount module

LLCR2-(F) #2 lens - specify finish in place of (F)
LLCR3-(F) #3 lens - specify finish in place of (F)

Wireless system remote controller accessory

Wireless system offers a remote radio/sensor module that allows to connected to a Limelight system (sold by other). Remote module can be mounted to wall or pole with j-box supplied. May be specified by choosing one of two different lenses to accommodate a variety of mounting heights/sensor detection ranges. Must specify option DD on luminaires that are planned to be used with remote mount controllers. See page 4 for Wireless system details.

Dimensions

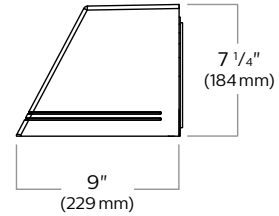
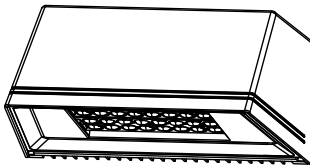

Motion Response

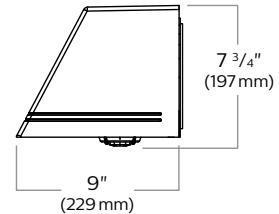
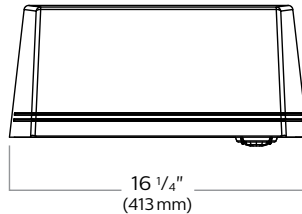
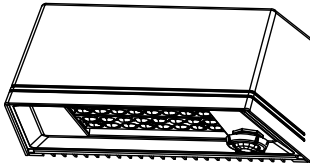

Wireless Controls

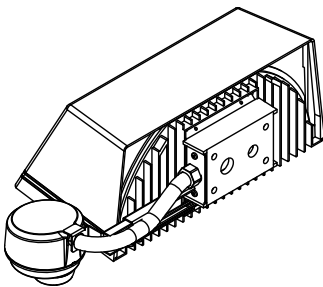
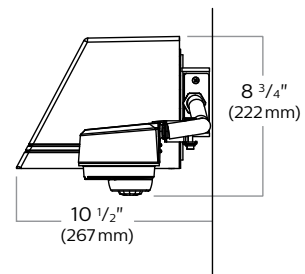
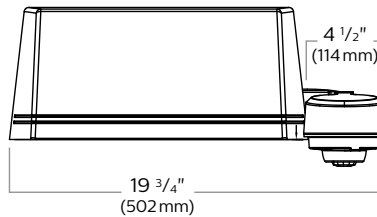
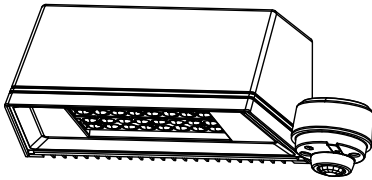

Luminaire Weights

LED Wall Sconce 101L	Weight
Luminaire	13.5 lbs
Luminaire - EBPC (EM battery pack)	17.0 lbs
Luminaire - Integrated system controls	16.3 lbs

101L Sconce LED

Wall Mount

LED Wattage and Lumen Values

Ordering Code	LED Qty	LED Current (mA)	Color Temp.	Average System Watts ¹	Type 2			Type 3			Type 4		
					Lumen Output ^{1,2}	BUG Rating	Efficacy (LPW)	Lumen Output ^{1,2}	BUG Rating	Efficacy (LPW)	Lumen Output ^{1,2}	BUG Rating	Efficacy (LPW)
101L-16L-530-NW-G1	16	530	4000K	28	2944	B1-U0-G0	106	2687	B1-U0-G1	97	2747	B1-U0-G1	99
101L-16L-700-NW-G1	16	700	4000K	37	3789	B1-U0-G1	103	3458	B1-U0-G1	94	3535	B1-U0-G1	96
101L-16L-1000-NW-G1	16	1000	4000K	55	5050	B1-U0-G1	92	4609	B1-U0-G1	84	4712	B1-U0-G1	86
101L-16L-1200-NW-G1	16	1200	4000K	65	5744	B2-U0-G1	89	5242	B1-U0-G2	81	5359	B1-U0-G2	83
101L-32L-530-NW-G1	32	530	4000K	52	5698	B2-U0-G1	110	5200	B1-U0-G2	100	5316	B1-U0-G2	102
101L-32L-700-NW-G1	32	700	4000K	70	7242	B2-U0-G1	103	6609	B1-U0-G2	94	6757	B1-U0-G2	96
101L-32L-1000-NW-G1	32	1000	4000K	107	9797	B2-U0-G1	92	8941	B2-U0-G2	84	9140	B2-U0-G2	86

LED Wattage and Lumen Values (Emergency Mode)³

Ordering Code	LED Qty	LED Current (mA)	Color Temp.	Ave. System Watts (charging mode)	Type 2	Type 3	Type 4
101L-16L-NW-EBPC	16	N/A	4000K	14	1345	1228	1255
101L-32L-NW-EBPC	32	N/A	4000K	14	1754	1600	1636

1. Wattage and lumen output may vary by +/- 8% due to LED manufacturer forward volt specification and ambient temperature. Wattage shown is average for 120V through 277V input. Actual wattage may vary by an additional +/- 10% due to actual input voltage.
2. Lumen values based on photometric tests performed in compliance with IESNA LM-79.
3. For emergency EBPC option, publish values are based on initial lumens.

Luminaire options

DD: 0-10V dimming driver with leads supplied through back of luminaire (for secondary dimming controls by others).

Dynadimmer Automatic Profile Dimming: Automatic dimming profiles (CS50/CM50/CE50) offer safety, median, or economy settings, for shorter or longer duration. Dimming profiles provide flexibility towards energy savings goals while optimizing light levels during specific dark hours. 50% dimming is standard. DA50 offers 50% instantaneous dimming all night (during all dark hours). Other dimming settings are also available if different light levels are required (contact Technical Support for details).

Profile	Dimming		
	Schedule	Duration	Level
Economy	9 PM - 6 AM	9 hours	50%
Median	10 PM - 6 AM	8 hours	50%
Safety	11 PM - 6 AM	7 hours	50%
Reactive 50	all night	dynamic	50%

TLRD5: Twist Lock Receptacle with 5 pins enabling dimming, can be used with a twistlock photoelectric cell or a shorting cap. Can also be used with third party control system.

TLRD7: Twist Lock Receptacle with 7 pins enabling dimming and additional functionality, can be used with twistlock photoelectric cell or a shorting cap. Can also be used with third party control system.

TLRDPC: Receptacle with twistlock photoelectric cell (must specify voltage). Receptacle located on top of luminaire housing.

IMRI2, IMRI3: Infrared Motion Response Integral (IMRI). IMRI module is mounted integral to the luminaire door and is available with two different sensor lens types to accommodate various mounting heights and occupancy detection ranges (see charts for approximate detection patterns). Motion response used in combination of Dynadimmer and SiteWise are not programmable and used to override controllers schedule when motion is detected. When used not combined with any controller, IMRI is set/operates in the following fashion: The motion sensor is set to a constant 50%. When motion is detected by the PIR sensor, the luminaire returns to 100% light output. Dimming on low is factory set to 50% with 5 minute default in "full power" prior to dimming back to low. When no motion is detected for 5 minutes, the motion response system reduces the wattage by 50% of the normal constant wattage reducing the light level. IMRI can also be specified with automatic profile dimming for the added benefit of a combined dimming profile with sensor detection, where the PIR sensor will override the dimming profile when occupancy is detected. Passive infrared (PIR) motion sensor, WattStopper FSP-211, equipped with lens choice specified. Available from 120V to 277V input only. Motion sensor off state power is 0.0 watts. The FSP-211 can also be reprogrammed with WattStopper's FSIR-100 remote programming tool accessory.

DCC: Dual Circuit Control permits separate switching of 32L models only, where a quantity of (2) 16 LED modules are controlled independently by use of two sets of leads, one for each module.

Wireless system: 101L luminaires are available with optional wireless controllers ready to be connected to a Limelight system (sold by other). The system allows you to Wirelessly manage the entire site, independent lighting groups or individual luminaires while on-site or remotely. Based on a high density mesh network with an easy to use web-based portal, you can conveniently access, monitor and manage your lighting network remotely. Wireless System can be combined with site and area, pedestrian, and parking garage luminaires as well, for a completely connected outdoor.

101L Sconce LED

Wall Mount

Luminaire options (continued)

F1: Fusing Single (for 120, 277 or 347VAC)

F2: Fusing Double (for 208, 240 or 480VAC)

F3: Fusing Canadian Double Pull (for 208, 240 or 480VAC)

EBPC: Emergency battery pack is cold weather rated down to -20C (-4F) and integral to the luminaire, allowing for a consistent look between emergency and non-emergency sconces. A separate surface mount accessory box is not required. Dual light engines (32L) are wired in parallel, both operating in emergency mode to meet various redundancy lamp

requirements. Also available with single light engine (16L). Secondary driver with relay immediately detects AC power loss and powers luminaire for a minimum of 90 minutes from the time power is lost.

Infrared Motion Response and Wireless system sensor coverage patterns

LLC2/3 Luminaire mounted controller

Controller attached to luminaire and includes radio, photocell and motion sensor with #2 or #3 lens for 8-20' mounting heights.

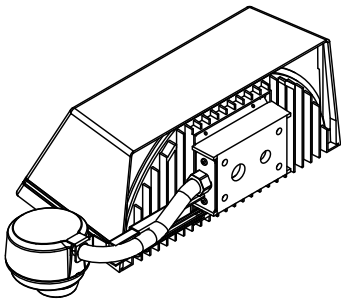
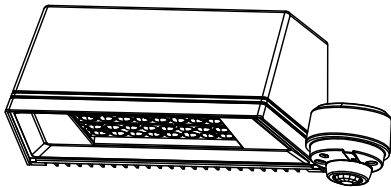

IMRI2/LLC2/LLCR2

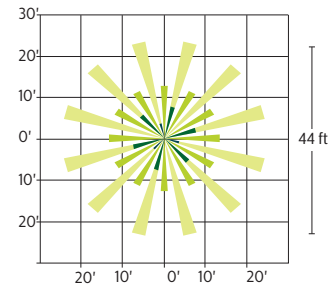
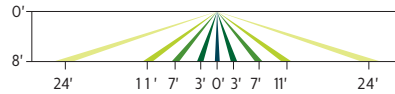

IMRI3/LLC3/LLCR3

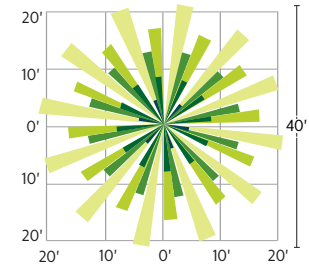
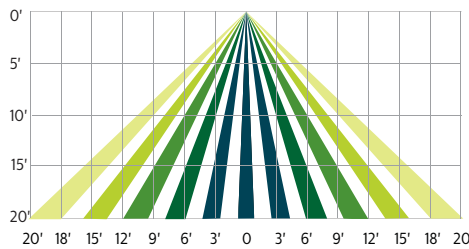

Remote Mount Wireless Controller

Used to extend the communication on site, to extend motion response and add other luminaires that are not pole mounted. Consult factory for more information.

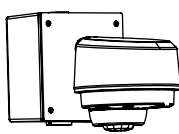

Controller

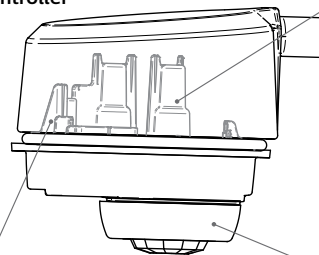

Wireless Radio

- 1.8 Watts max (no load draw)
- Operating voltage 120-277 VAC RMS
- Communicates using the ZigBee protocol
- Carries out dimming commands from Gateway
- Reports ambient light readings to 1500 Ft-Cd
- Transmission Systems Operating within the band 2400-2483.5Mhz
- ROHS Compliant

Photocell

- Ambient light photocell on every wireless radio that averages the light levels of up to 5 controllers for an accurate reading and optimal light harvesting activity.
- Reports ambient light readings to 1500 Fc.

Motion Response

- Detects motion through passive infrared sensing technology with three different lens configurations
- Motion sensor coverage can be adjusted from a narrow to a wide detection range, which helps reduce false triggers to further increase energy savings.
- Sensing profiles can be updated to adapt to activity levels in the environment, such as occupancy level, wind, and mounting height

101L Sconce LED

Wall Mount

Specifications

Housing

Main body cast housing and back plate made of a low copper die cast Aluminum alloy for a high resistance to corrosion, 0.100" (2.5mm) minimum thickness. Hinged door allows access to driver and LED compartment.

Mounting

Mounting is completed through integral back plate that features a separate recessed feature for hook and lock quick mount plate that secures with two set screws from bottom of luminaire. Mounting plate is located in the center of the luminaire width and 3.5" above the luminaire bottom (lens down position). Luminaire ships fully assembled, ready to install.

Light Engine

Composed of 4 main components: Heat Sink / LED Module / Optical System / Driver. Electrical components are RoHS compliant. IP66 sealed light engines. LEDs tested by ISO 17025-2005 accredited lab in accordance with IESNA LM-80 guidelines extrapolations in accordance with IESNA TM-21. Metal core board ensures greater heat transfer and longer lifespan.

Heat Sink

Integral door/heat sink design made of low copper die cast Aluminum alloy for a high resistance to corrosion.

LED Module

Composed of high performance white LEDs. Color temperature as per ANSI/NEMA bin Neutral White, 4000K nominal (+/- 275K), CRI 70 Min. Available in other color temperatures including Cool White, 5700K and Warm White, 3000K.

Hardware

All exposed screws shall be stainless and/or corrosion resistant and captive.

Optical System

The advanced LED optical systems provide IES Types 2, 3, 4. Composed of high performance UV stabilized optical grade polymer refractor lenses to achieve desired distribution optimized to get maximum spacing, target lumens and a superior lighting uniformity. System is rated IP66. Performance shall be tested per LM-63, LM-79 and TM-15 (IESNA) certifying its photometric performance. Dark sky compliant with 0% uplight and U0 per IESNA TM-15.

Driver

High power factor of 90% min. Electronic driver, operating range 50/60 Hz. Auto adjusting universal voltage input from 120 to 277 VAC or 347 to 480 VAC rated for both application line to line or line to neutral, Class I, THD of 20% max. The current supplying the LEDs will be reduced by the driver if the driver experiences internal overheating as a protection to the LEDs and the electrical components. Output is protected from short circuits, voltage overload and current overload. Automatic recovery after correction. Standard built in driver surge protection of 2.5kV (min).

Surge Protection

Each luminaire is provided as standard with surge protector (designed SPI) tested in accordance with ANSI/IEEE C62.45 per ANSI/IEEE C62.41.2 Scenario I Category C High Exposure 10kV/5kA waveforms for Line Ground, Line Neutral and Neutral Ground, and in accordance with U.S. DOE (Department of Energy) MSSLC (Municipal Solid State Street Lighting Consortium) Model Specification for LED Roadway Luminaires Appendix D Electrical Immunity High Test Level 10kV / 5kA.

Wiring (supplied by others)

Splices must be made in the junction box.

Finish

Five standard colors offered in textured black, white, bronze, dark gray and medium gray. Color in accordance with the AAMA 2604 standard. Application of polyester powder coat paint 2.5 mils minimum. The thermosetting resins provides a discoloration resistant finish in accordance with the ASTM D2244 standard, as well as luster retention in keeping with the ASTM D523 standard and humidity proof in accordance with the ASTM D2247 standard. RAL and custom color matching available.

LED Products Manufacturing Standard

The electronic components sensitive to electrostatic discharge (ESD) such as light emitting diodes (LEDs) are assembled in compliance with EC61340-5-1 and ANSI/ESD S20.20 standards so as to eliminate ESD events that could decrease the useful life of the product.

LED Useful Life

Luminaire Useful Life accounts for LED lumen maintenance. Refer to IES files for energy consumption and delivered lumens for each option. Based on ISTMT in situ thermal testing in accordance with UL1598 and UL8750, LED LM-80/TM-21, expected to reach 100,000 + hours with >L70 lumen maintenance @ 25°C.

Certifications and Compliance

cULus Listed for Canada and USA suitable for wet locations when mounted downward facing. cULus Listed for Canada and USA suitable for damp locations when inverted upward facing when mounted in covered ceiling application. Emergency Battery Pack option is tested and listed to UL924 and CSA C22.2 No. 141-10 DesignLights Consortium qualified on models as listed on DLC QPL. Luminaire is rated for operation in ambient temperature of -40°C (-40°F) up to +40°C (+104°F).

Limited Warranty

5-year limited warranty. See signify.com/warranties for details and restrictions. Visit our eCatalog or contact your local sales representative for more information.

101L Sconce LED

Wall Mount

LED Performance

Predicted lumen depreciation data ¹				
Ambient Temperature (°C)	Driver mA	Calculated L ₇₀ hours ^{1,2}	L ₇₀ per TM-21 ^{2,3}	Lumen Maintenance % @ 60,000 hours
25°C	up to 1200 mA	>100,000	>60,000	88%

1. Predicted performance derived from LED manufacturer's data and engineering design estimates, based on IESNA LM-80 methodology. Actual experience may vary due to field application conditions.
2. L₇₀ is the predicted time when LED performance depreciates to 70% of initial lumen output.
3. Calculated per IESNA TM21-11. Published L₇₀ hours limited to 6 times actual LED test hours.

Buy American Act of 1933 (BAA):

This product is manufactured in one of our US factories and, as of the date of this document, this product was considered a commercially available off-the-shelf (COTS) item meeting the requirements of the BAA. This BAA designation hereunder does not address (i) the applicability of, or availability of a waiver under, the Trade Agreements Act, or (ii) the "Buy America" domestic content requirements imposed on states, localities, and other non-federal entities as a condition of receiving funds administered by the Department of Transportation or other federal agencies. Prior to ordering, please visit www.signify.com/baa to view a current list of BAA-compliant products to confirm this product's current compliance.



© 2021 Signify Holding. All rights reserved. The information provided herein is subject to change, without notice. Signify does not give any representation or warranty as to the accuracy or completeness of the information included herein and shall not be liable for any action in reliance thereon. The information presented in this document is not intended as any commercial offer and does not form part of any quotation or contract, unless otherwise agreed by Signify.

Signify North America Corporation
400 Crossing Blvd, Suite 600
Bridgewater, NJ 08807
Telephone 855-486-2216

Signify Canada Ltd.
281 Hillmount Road,
Markham, ON, Canada L6C 2S3
Telephone 800-668-9008

All trademarks are owned by Signify Holding or their respective owners.