



Top Selling Stock Ready Luminaires

2024 Q4 Select Edition

CHLORIDE

LIGHTOLIER

Day-Brite

Stonco

Stock Ready

Genlyte Solutions offers the most complete stock offering in the industry.

We provide conventional and LED lamps, ballasts, drivers, retrofit kits, as well as indoor and outdoor stock luminaires. Save time and improve efficiencies by consolidating your stock purchases with Genlyte Solutions.



A long history of excellence

As the global leader in lighting for more than 125 years, Signify has the know-how and most comprehensive portfolio to meet any application. We achieved 100% Carbon Neutrality in 2020. We are number 1 in conventional lamps, LED and Connected lighting. We have over 17, 750 patents. We invest 4.8% of total sales in R&D which is two times our nearest competitor! Partnership is more than sales.

Let's grow together. We are ready to go with you.

Quick and reliable service out of our distribution centers.



Find just what you need

Our Stock Ready portfolio makes it easy to find just what you need. Our products are designed for easy ordering through the Signify portal, easy to install with minimal steps, and competitively priced to meet the demands of budget conscious projects focused on cost and energy. Distributors can also benefit from our Stock Ready program which offers deals on freight, guaranteed sales, price change reimbursement, delistment notifications, marketing support, merchandising, and more.

Certifications & labels



The right solution

Signify provides the solution to every lighting need whether it's lighting and connecting your public spaces, giving your commercial building an energy saving upgrade, or working on a yet to be constructed hospital, we've got you covered.

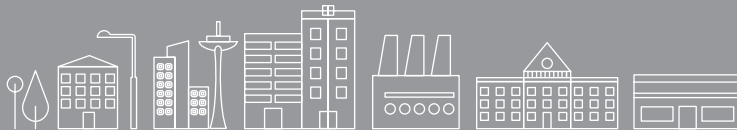
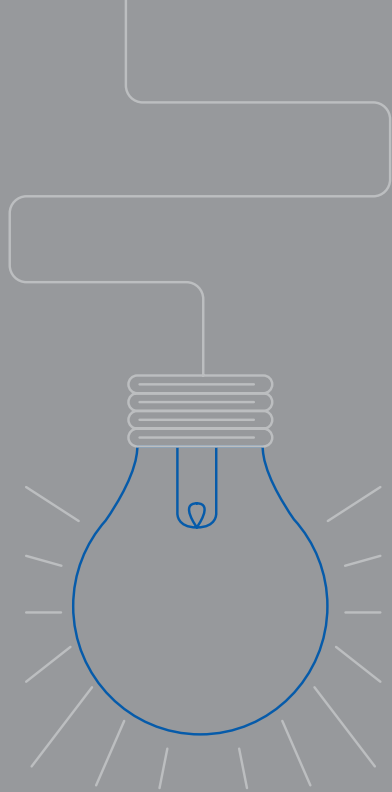

Government

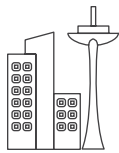

Cities

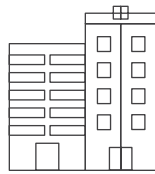

Offices

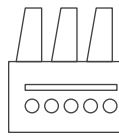

Industry



Education

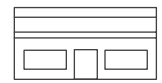

Retail



Ballasts and Drivers



Lamps and Tubes



Retrofit kits



Value-grade fixtures



Specification-grade lighting



Connected lighting

Stock up on our new field selectable products

With the unique convenience of adjustable color temperatures and/or lumen outputs, our new Field Selectable product lines make it easy to always have the right product for the job. Field Selectable products give you the added benefit of carrying one SKU versus multiple SKUs, keeping your inventory low and turns high. These product lines are priced right as part of our Stock Ready offering.



Lumen Select Switch



CCT with Select Switch



NEW
Flex Fit (Hor/Ver adj.) PLED lamps with selectable CCT



NEW
Flex Fit TLED lamps with selectable CCT



NEW
MainsFit CorePro TLED lamps with selectable CCT, Lumen and base



MainsFit CorePro PLED lamps with selectable CCT



MasterClass LED corn cob lamps with selectable CCT & LM



MasterClass high wattage LED corn cob lamps with selectable CCT



Flat Downlight LED dual select



Commercial Retrofit Downlight LED dual select



Residential Retrofit Downlight LED select



Surface Mount Downlight LED dual select



ModuLyte LED dual select



Gimbal & Downlight LED dual select



EvoKit Click retrofit kit LED dual select



SDS Selectable Strip LED dual select



NWL Wraparound LED dual select



VTS Vaportight LED dual select



FCY Value High Bay LED dual select



SBP Selectable Backlit Panel LED dual select



DSRT Selectable Troffer LED dual select



HCY Sealed High Bay LED dual select



Slim Flood LED dual select



Wall Pack LED dual select



Garage & Canopy LED dual select



Area Light LED select



Security Light LED select



Adjustable Slim & Residential Wall Packs LED dual select



LytePro Area Light LED select

PHILIPS

LIGHTOLIER

Day-Brite

Stonco

ModuLyte LED

Selectable Lumens and CCTs

Conveniently toggle Lumen and CCT switches to make adjustments, resulting in the right light for each environment

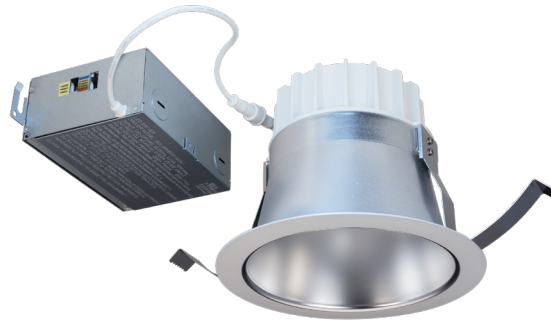

Why choose ModuLyte LED?

- Quick connect: low voltage plenum-rated cable screws together with twist-lock to attach driver to light engine
- Easy access: to driver after installation
- Retention spring: designed for shallow ceiling plenum and easy maneuvering
- Frames: Optional new construction accessory frames
- Optics: Field interchangeable beams and wall wash
- Accessories: Goof ring accessories expand retrofit capability



ModuLyte LED

Catalog Number	UPC Code	Model Number	Description	C/P Qty	Distr. Ctr.
ModuLyte LED 4" Round Downlight					
Wide beam • 1500/2000/2500lm • 90CRI with 2700/3000/3500/4000/5000K CCTs					
M4RDL259CSWCLZ10U	190096192793	912401592618	CL/WH Z10 UNV	6/120	TN, PA, CA
M4RDL259CSWCDZ10U	190096192809	912401592619	CD/WH Z10 UNV	6/120	TN, PA, CA
M4RDL259CSWWHZ10U	190096192816	912401592620	WH/WH Z10 UNV	6/120	TN, PA, CA
ModuLyte LED 6" Round Downlight					
Wide beam • 1500/2000/2500lm • 90CRI with 2700/3000/3500/4000/5000K CCTs					
M6RDL259CSWCLZ10U	190096192823	912401592621	CL/WH Z10 UNV	6/72	TN, PA, CA
M6RDL259CSWCDZ10U	190096192830	912401592622	CD/WH Z10 UNV	6/72	TN, PA, CA
M6RDL259CSWWHZ10U	190096192847	912401592623	WH/WH Z10 UNV	6/72	TN, PA, CA
Meium beam • 3000/3500/4000lm • 90CRI with 2700/3000/3500/4000/5000K CCTs					
M6RDL409CSMCLZ10U	190096192854	912401592624	CL/WH Z10 UNV	6/72	TN, PA, CA
M6RDL409CSMCDZ10U	190096192861	912401592625	CD/WH Z10 UNV	6/72	TN, PA, CA
M6RDL409CSMWHZ10U	190096192878	912401592626	WH/WH Z10 UNV	6/72	TN, PA, CA
ModuLyte LED 8" Round Downlight					
Wide beam • 1500/2000/2500lm • 90CRI with 2700/3000/3500/4000/5000K CCTs					
M8RDL259CSWCLZ10U	190096192885	912401592627	CL/WH Z10 UNV	4/48	TN, PA, CA
M8RDL259CSWCDZ10U	190096192892	912401592628	CD/WH Z10 UNV	4/48	TN, PA, CA
M8RDL259CSWWHZ10U	190096192908	912401592629	WH/WH Z10 UNV	4/48	TN, PA, CA
Meium beam • 3000/3500/4000lm • 90CRI with 2700/3000/3500/4000/5000K CCTs					
M8RDL409CSMCLZ10U	190096192915	912401592630	CL/WH Z10 UNV	4/48	TN, PA, CA
M8RDL409CSMCDZ10U	190096192922	912401592631	CD/WH Z10 UNV	4/48	TN, PA, CA
M8RDL409CSMWHZ10U	190096192939	912401592632	WH/WH Z10 UNV	4/48	TN, PA, CA

Cat. No.	UPC Code	Model Number	Description	C/P Qty	Distr. Ctr.
ModuLyte LED 4" Accessories					
M4RLW	190096193134	912401592651	Lens Wall Wash Optics	6/768	TN, PA, CA
M4MED	190096193165	912401592654	Medium Beam Optics	6/	TN, PA, CA
M4GRW	190096193189	912401592656	Goof Ring White	6/	TN, PA, CA
4RNSR	190096192526	912401592564	Frame SQ BH NJB	8/288	TN, PA, CA
ModuLyte LED 6" Accessories					
M6RLW	190096193141	912401592652	Lens Wall Wash Optics	6/324	TN, PA, CA
M6MED	190096193172	912401592655	Medium Beam Optics	6/	TN, PA, CA
M6GRW	190096193196	912401592657	Goof Ring White	6/	TN, PA, CA
6RNSR	190096192533	912401592565	Frame SQ BH NJB	8/192	TN, PA, CA
ModuLyte LED 8" Accessories					
M8RLW	190096193158	912401592653	Lens Wall Wash Optics	4/180	TN, PA, CA
M8MED	190096193226	912401592672	Medium Beam Optics	6/	TN, PA, CA
M8GRW	190096193202	912401592658	Goof Ring White	6/	TN, PA, CA
8RNR	190096192946	912401592635	Frame SQ BH NJB	8/192	TN, PA, CA



Residential Retrofit Downlight 5/6"



Residential Retrofit Downlight 4"



Residential Retrofit Downlight

An LED retrofit as **easy as snap and click**

Hassle-free install will save you time and frustration on the job site. You may not even need to open your toolbox.



Why choose Retrofit Downlight?

- Adjustable color temperature switch allows you to make choices while your install or afterward
- Utilizes existing frames to make replacing old downlighting and upgrading to LED a truly easy task
- Flexible springs allow for installation without tools
- Quick-connect plug and medium-based socket adapter means no extra accessories to purchase

Residential Retrofit Downlight LED select

Catalog Number	UPC Code	Model Number	Product Description	Compliance	Case/Pallet Qty	Distribution Center
Residential Retrofit Downlight 4" Round						
RD4R79301W	190096131976	911401868184	4" Round, 700lm, 90CRI, 3000K, 120V	ENERGY STAR®	16/560	PA TN CA
RD4R79SCT1W	190096131952	911401867984	4" Round, 700lm, 90CRI, 5CCT, 120V	ENERGY STAR®	12/300	PA TN CA
Residential Retrofit Downlight 5/6" Round						
RD6R99301W	190096131983	911401868284	6" Round, 900lm, 90CRI, 3000K, 120V	ENERGY STAR®	16/560	PA TN CA
RD6R99SCT1W	190096131969	911401868084	6" Round, 900lm, 90CRI, 5CCT, 120V	ENERGY STAR®	12/300	PA TN CA
Residential Retrofit Accessory						
RD4RR	190096196258	911401808885	6" Remodeler housing	—	6	PA
RD4RN	190096196609	911401833685	4" Frame-in kit housing	—	6	PA
RD6RR	190096196593	911401833585	6" Remodeler housing	—	6	PA
RD6RN	—	—	6" Frame-in kit housing	—	6	PA



Commercial Retrofit Downlight

Bright, brighter, **brightest**

Will reduce onsite time and headaches for busy installers with its adjustable lumen and color output switch.



Why choose Commercial Retrofit Downlight?

- Adjustable lumen output and color temperature switch allows you to make choices while you install or afterward
- Great for different ceiling heights and different light level needs
- Sturdy metal clips provide a solid fit and easy installation
- Out-of-the-box pre-wired with flexible metal conduit
- 50,000 hour rated life (L70)



Commercial Retrofit Downlight LED dual select

Catalog Number	UPC Code	Model Number	Product Description	Compliance	C/P Qty	Distr. Ctr.
Commercial Retrofit Downlight 4" Round						
CR4RLMCCT	190096131266	911401870081	4" Round, 500-1000lm, 90CRI, 3000K-3500K-4000K, White Finish, 120-347V	—	288	TN, PA
Commercial Retrofit Downlight 6" Round						
CR6RLMCCT	190096131273	911401870181	6" Round, 700-1500lm, 90CRI, 3000K-3500K-4000K, White Finish, 120-347V	—	120	CA, TN, PA
Commercial Retrofit Downlight 8" Round						
CR8RLMCCT	190096131280	911401870281	8" Round, 1000-2000lm, 90CRI, 3000K-3500K-4000K, White Finish, 120-347V	—	72	CA, TN, PA
Commercial Retrofit Downlight 10" Round						
CR10RLMCCT	190096131297	911401870381	10" Round, 2000-3000lm, 90CRI, 3000K-3500K-4000K, White Finish, 120-347V	—	48	TN, PA

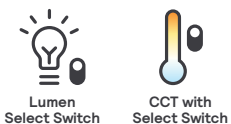

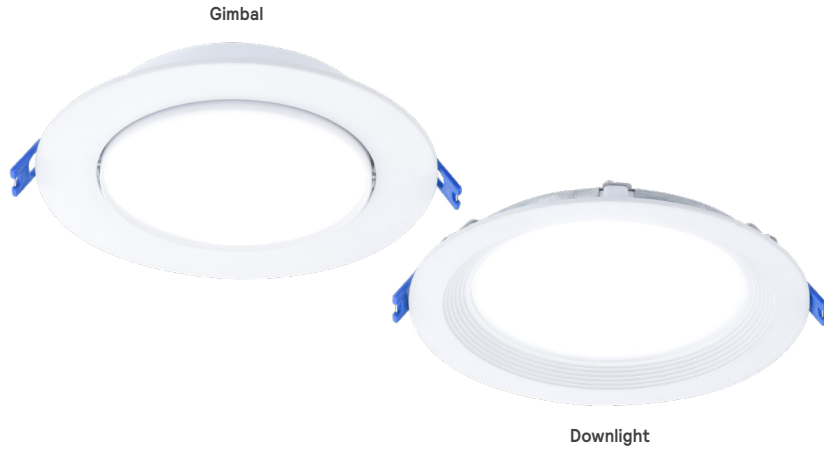

Downlight and Gimbal

The CCT and Lumen selection features make it easy to adjust at the time of installation.



Why choose Downlight and Gimbal?

- Sizes: 3, 4, & 6 inch round
- Dimming: TRIAC down to 10%
- Installation: Easy with detachable junction box
- Lifetime: L70 at 50,000 hours
- Listings: ENERGY STAR®[®], Title 24 (JA8-2016), damp location, ETL listed. Airseal IC.
- Warranty: 5 year limited

Downlight & Gimbal LED dual select

Catalog Number	UPC Code	Model No.	Product Description	Compliance	C/P Qty	Dist. Ctr.
Downlight 3" Round (2700K-3000K-3500K-4000K-5000K)						
DL3RSLMZ10SCTUW	190096131853	911401837684	370lm/500lm, UNV	ENERGY STAR®	8/320	PA TN CA
DL3R4ESCT1W	190096196234	911401884284	500lm, 120V	ENERGY STAR®	8/384	PA TN CA
Downlight 4" Round (2700K-3000K-3500K-4000K-5000K)						
DL4RSLMZ10SCTUW	190096131877	911401837884	540lm/700lm, UNV	ENERGY STAR®	8/240	PA TN CA
DL4R7ESCT1W	190096131914	911401837784	700lm, 120V	ENERGY STAR®	20/640	PA TN CA
Downlight 6" Round (2700K-3000K-3500K-4000K-5000K)						
DL6RSLMZ10SCTUW	190096131891	911401838084	900lm/1100lm, UNV	ENERGY STAR®	8/160	PA TN CA
DL6R1IESCT1W	190096131884	911401837984	1100lm, 120V	ENERGY STAR®	10/300	PA TN CA
Gimbal 3" Round (2700K-3000K-3500K-4000K-5000K)						
GB3RSLMZ10SCTUW	190096131907	911401837184	370lm/500lm, UNV	ENERGY STAR®	8/320	PA TN CA
GB3R4ESCT1W	190096196227	911401884184	500lm, 120V	ENERGY STAR®	8/384	PA TN CA
Gimbal 4" Round (2700K-3000K-3500K-4000K-5000K)						
GB4RSLMZ10SCTUW	190096131921	911401837384	540lm/700lm, UNV	ENERGY STAR®	8/240	PA TN CA
GB4R7ESCT1W	190096131860	911401837284	700lm, 120V	ENERGY STAR®	8/480	PA TN CA
Gimbal 6" Round (2700K-3000K-3500K-4000K-5000K)						
GB6RSLMZ10SCTUW	190096131945	911401837584	900lm/1100lm, UNV	ENERGY STAR®	8/160	PA TN CA
GB6R1IESCT1W	190096131938	911401837484	1100lm, 120V	ENERGY STAR®	6/240	PA TN CA

Cat. No.	UPC Code	Model No.	Product Description	C/P Qty	Dist. Ctr.
Gimbal Dual Select Square Black Trim					
DSGB6RTBK	190096196449	911401810785	6" Trim Black	80	PA
DSGB4RTBK	190096196401	911401810385	4" Trim Black	180	PA
DSGB3RTBK	190096196425	911401810585	3" Trim Black	180	PA
Downlight Dual Select Square Black Trim					
DSDL6RTBK	190096196432	911401810685	6" Trim Black	80	PA
DSDL4RTBK	190096196456	911401810885	4" Trim Black	180	PA
DSDL3RTBK	190096196579	911401833385	3" Trim Black	180	PA
New Construction Plate					
DSANCP468	190096196364	911401809985	4" 6" 8" Plate	10	PA
New Construction Plate Round					
DSANCP5	190096196265	911401808985	5" Plate	10	PA
DSANCP468	190096196364	911401809985	4" 6" 8" Plate	10	PA
DSANCP346	190096196357	911401809885	3" 4" 6" Plate	10	PA
New Construction Plate Square					
DSANCP468	190096196319	911401809485	4" 6" 8" Plate	10	PA
DSANCP346	190096196289	911401809185	3" 4" 6" Plate	10	PA
Dual Select Extension Cord					
DSAEC20	190096196272	911401809085	20" Ext. Cord	250	PA

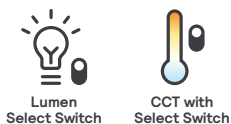

Surface Mount Downlight

The shallow ceiling **problem solver**

Ideal when faced with a challenging ceiling, but you still want a good-looking downlight.

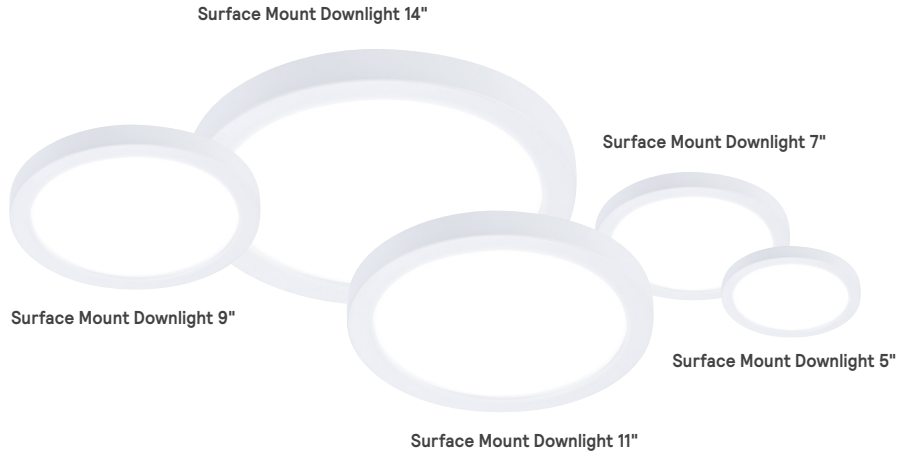

Why choose Surface Mount Downlight?

- Easy to install on standard J-boxes
- Surface mount downlight solves the problem of limited plenum space
- Glare controlling lens for comfortable light distribution
- Affordable alternative to Air-Seal IC recessed housings
- Support wire attached for easy installation
- ENERGY STAR® and Title 24 listed



Surface Mount Downlight LED dual select

Catalog Number	UPC Code	Model Number	Product Description	Compliance	Case/Pallet Qty	Distr. Ctr.
Surface Mount Downlight 5" Round						
SD5R7ESCT1W	190096131785	911401836484	5" Round, 700lm, 90CRI, 2700K-3000K-3500K-4000K-5000K, 120V	ENERGY STAR®	8/672	PA TN CA
SD5RSLMZ10SCTUW	190096131792	911401836584	5" Round, 540lm/700lm, 90CRI, 2700K-3000K-3500K-4000K-5000K, UNV	ENERGY STAR®	8/672	PA TN CA
Surface Mount Downlight 7" Round						
SD7R10ESCT1W	190096131808	911401836684	7" Round, 1000lm, 90CRI, 2700K-3000K-3500K-4000K-5000K, 120V	ENERGY STAR®	8/360	PA TN CA
SD7RSLMZ10SCTUW	190096131815	911401836784	7" Round, 800lm/1000lm, 90CRI, 2700K-3000K-3500K-4000K-5000K, UNV	ENERGY STAR®	8/360	PA TN CA
Surface Mount Downlight 9" Round						
SD9R12ESCT1W	190096196197	911401883884	9" Round, 1200lm, 90CRI, 2700K-3000K-3500K-4000K-5000K, 120V	ENERGY STAR®	8/192	PA TN CA
SD9RSLMZ10SCTUW	190096131822	911401836884	9" Round, 900lm/1200lm, 90CRI, 2700K-3000K-3500K-4000K-5000K, UNV	ENERGY STAR®	8/192	PA TN CA
Surface Mount Downlight 11" Round						
SD11R15ESCT1W	190096196203	911401883984	11" Round, 1500lm, 90CRI, 2700K-3000K-3500K-4000K-5000K, 120V	ENERGY STAR®	6/162	PA TN CA
SD11RSLMZ10SCTUW	190096131839	911401836984	11" Round, 1200lm/1500lm, 90CRI, 2700K-3000K-3500K-4000K-5000K, UNV	ENERGY STAR®	6/162	PA TN CA
Surface Mount Downlight 14" Round						
SD14R16ESCT1W	190096196210	911401884084	14" Round, 2000lm, 90CRI, 2700K-3000K-3500K-4000K-5000K, 120V	ENERGY STAR®	5/90	PA TN CA
SD14RSLMZ10SCTUW	190096131846	911401837084	14" Round, 1600lm/2000lm, 90CRI, 2700K-3000K-3500K-4000K-5000K, UNV	ENERGY STAR®	6/90	PA TN CA

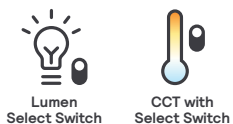

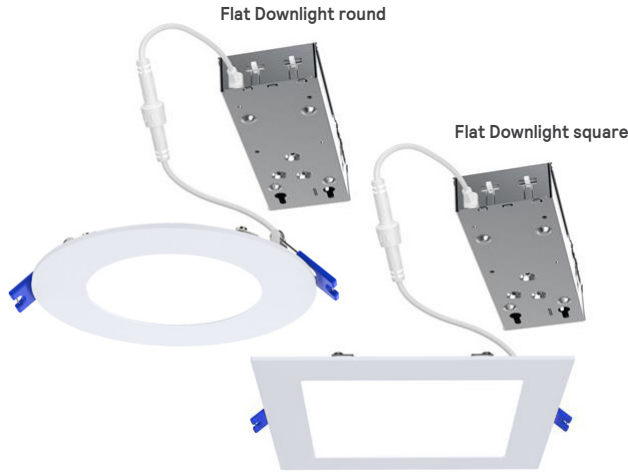

Flat Downlight

Make your next lighting project faster and easier, with a product from a name you can trust.



Why choose Flat Downlight?

- FD select: 4 field selectable CCT options
- FD dual select: 5 field selectable CCT and multiple lumen selection options
- Quick and easy installation without frame or reflector
- Junction box clips to luminaire meeting National Electric Code (NEC)
- Dimmable to 10%
- Lifetime >50,000 hours (L70)
- IC-rated for insulation direct contact
- UL1598 wet location rated

Flat Downlight LED dual select

Catalog Number	UPC Code	Model No.	Product Description	Cp.	C/P Qty	Dist. Ctr.
Flat Downlight Dual Select Round (2700K-3000K-3500K-4000K-5000K)						
FD3R7ESCT1W	190096196166	911401883584	3" Round, 480lm, WH, 120V	ES	12/384	PA TN CA
FD3RSLMZ10SCTUW	190096131679	911401825284	3" Round, 370lm/500lm, WH, UNV	ES	12/288	PA TN CA
FD4R7ESCT1W	190096131686	911401825384	4" Round, 700lm, WH, 120V	ES	20/360	PA TN CA
FD4RSLMZ10SCTUW	190096131693	911401825484	4" Round, 540lm/700lm, WH, UNV	ES	12/216	PA TN CA
FD5R9ESCT1W	190096196173	911401883684	5" Round, 900lm, WH, 120V	ES	6/270	PA TN CA
FD5RSLMZ10SCTUW	190096131709	911401825584	5" Round, 900lm/1100lm, WH, UNV	ES	6/180	PA TN CA
FD6R11ESCT1W	190096131716	911401825684	6" Round, 1100lm, WH, 120V	ES	10/300	PA TN CA
FD6RSLMZ10SCTUW	190096131723	911401825784	6" Round, 900lm/1100lm, WH, UNV	ES	6/180	PA TN CA
FD8R13ESCT1W	190096196180	911401883784	8" Round, 1300lm, WH, 120V	ES	6/144	PA TN CA
FD8RSLMZ10SCTUW	190096131730	911401825884	8" Round, 1100lm/1300lm, WH, UNV	ES	6/144	PA TN CA
Flat Downlight Dual Select Square (2700K-3000K-3500K-4000K-5000K)						
FD3SSLMZ10SCTUW	190096131747	911401825984	3" Square, 370lm/500lm, WH, UNV	ES	12/288	PA TN CA
FD4SSLMZ10SCTUW	190096131754	911401826084	4" Square, 540lm/700lm, WH, UNV	ES	12/216	PA TN CA
FD6SSLMZ10SCTUW	190096131761	911401826184	6" Square, 900lm/1100lm, WH, UNV	ES	6/180	PA TN CA
FD8SSLMZ10SCTUW	190096131778	911401826284	8" Square, 1100lm/1300lm, WH, UNV	ES	6/144	PA TN CA

ES = ENERGY STAR®

Cat. No.	UPC Code	Model No.	Product Description	C/P Qty	Dist. Ctr.
Flat Downlight Dual Select Round Black Trim					
DSFD8RTBK	190096196340	911401809785	8" Round	80	PA
DSFD6RTBK	190096196333	911401809685	6" Round	80	PA
DSFD5RTBK	190096196395	911401810285	5" Round	180	PA
DSFD4RTBK	190096196388	911401810185	4" Round	180	PA
DSFD3RTBK	190096196371	911401810085	3" Round	180	PA
Flat Downlight Dual Select Square Black Trim					
DSFD8STBK	190096196302	911401809385	8" Square	80	PA
DSFD6STBK	190096196296	911401809285	6" Square	80	PA
DSFD4STBK	190096196326	911401809585	4" Square	180	PA
DSFD3STBK	190096196418	911401810485	3" Square	180	PA
Flat Downlight New Construction Plate					
FD4NCP	190096131198	911401865081	4" Plate, 40/2000, factory		
FD6NCP	190096131204	911401865181	6" Plate, 40/2000, factory		
Flat Downlight Dual Select New Construction Plate Round					
DSANCPR5	190096196265	911401808985	5" Plate	10	PA
DSANCPR346	190096196357	911401809885	3" 4" 6" Plate	10	PA
Flat Downlight Dual Select New Construction Plate Square					
DSANCPSS346	190096196289	911401809185	3" 4" 6" Plate	10	PA
DSANCPSS468	190096196319	911401809485	4" 6" 8" Plate	10	PA
Flat Downlight Dual Select Extension Cord					
DSAEC20	190096196272	911401809085	20" Ext. Cord	250	PA



HCY Sealed High Bay

Modern design and **energy savings**

A great new look with no more sacrifices and dependability you can trust.



Why choose HCY Sealed High Bay?

- Lumen Selectable
- Field selectable color 4000K or 5000K
- Corrosion resistant black finish
- Heavy duty eyelet provided for connection to customer supplied suspension
- Accessory options of polycarbonate reflector and surface mount bracket
- Listed cULus for use in wet locations up to 50°C ambient, and IP65 rated



HCY Sealed High Bay LED dual select

Catalog Number	UPC Code	Model Number	Product Description	Compliance	C/P Qty	Distr. Ctr.
HCY Sealed High Bay (dual select)						
HCY0823L8CST-UN3-DIM-BK	190096197057	911401809987	8,000-23,000lm, 80CRI, 4000K/5000K, 0-10V UNV, 120-347V, Black	DLC Premium	1/84	PA, CA, TN, IL
HCY0823L8CST-UN3-DIM-WH	190096197149	911401820487	8,000-23,000lm, 80CRI, 4000K/5000K, 0-10V UNV, 120-347V, White	DLC Premium	1/84	PA
HCY2437L8CST-UN3-DIM-BK	190096197064	911401810087	24,000-37,000lm, 80CRI, 4000K/5000K, 0-10V UNV, 120-347V, Black	DLC Premium	1/42	PA, CA, TN, IL
HCY2437L8CST-UN3-DIM-WH	190096197156	911401820587	24,000-37,000lm, 80CRI, 4000K/5000K, 0-10V UNV, 120-347V, White	DLC Premium	1/42	PA
HCY Accessories						
HCY3-PRSM	190096197101	911401810487	Clear Polycarbonate Reflector for HCY0823L	—	10/80	PA, CA, TN
HCY3-PRLG	190096197095	911401810387	Clear Polycarbonate Reflector for HCY2437L	—	10/40	PA, CA, TN, IL
HCY3-LCSMLG	190096197217	911401821987	Bottom Lens Cover for Polycarbonate Reflector	—	10/240	PA
HCY3-WGSM	190096197194	911401821787	Wireguard for HCY0823L	—	20/960	PA
HCY3-WGLG	190096197200	911401821887	Wireguard for HCY2437L	—	20/720	PA
HCY-SENSOR	190096131662	911401874682	Sensor	—	50/4500	PA, CA, TN, IL
HCY-REMOTE	190096131143	911401855781	Remote 4 Sensor Program	—	20/4800	TN
HCY-SURFACE BKT SM	190096131174	911401856081	Surface Mount Bracket for HCY0823	—	10/240	PA, CA, IL
HCY-SURFACE BKT LG	190096131181	911401856181	Surface Mount Bracket for HCY2437	—	10/180	PA, CA, TN



Field selectable
Lumens and CCT
of 4000K or 5000K

FCY Value High Bay

Update and upgrade for **real savings**

Low profile and durable design, efficiency and great price – FCY value high bay has it all.



Why choose FCY Value High Bay?

- Die formed sheet metal housing and end plates
- Corrosion resistant gloss white paint after fabrication
- V-hooks and 48" chains supplied (set of 2) for installation
- Lumen maintenance up to 70% (L70) at 50,000 hours
- Access plate located on top of housing for easy wiring
- cULus listed for use in damp locations, -20°C to 45°C ambient

FCY Value High Bay LED dual select

Catalog Number	UPC Code	Model Number	Product Description	Compliance	C/P Qty	Distribution Center
FCY Value High Bay (dual select)						
FCY0815L8CST-UNV-DIM	190096192571	912401592578	FCY Linear HB 8/12/15lm 40-50K UNV	DLC Premium	1/170	CA, TN, PA, IL
FCY1524L8CST-UNV-DIM	190096192588	912401592579	FCY Linear HB 15/18/24lm 40-50K UNV	DLC Premium	1/153	CA, TN, PA, IL
FCY2436L8CST-UNV-DIM	190096192595	912401592580	FCY Linear HB 24/30/36lm 40-50K UNV	DLC Premium	1/68	CA, TN, PA, IL
FCY Accessories						
FCY-REMOTE	190096192694	912401592590	FCY Linear HB Remote 4 Sensor program	—	20/1120	PA
FCY-SENSOR	190096192700	912401592591	FCY Linear HB Sensor	—	20/1120	PA
FCY-WG15	190096192717	912401592592	FCY Linear HB Wire Guard 15lm	—	45/1800	PA
FCY-WG24	190096192724	912401592593	FCY Linear HB Wire Guard 24lm	—	45/1800	PA
FCY-PENHGR24	190096192731	912401592594	FCY Linear HB Pndnt Hngr Kit 15lm & 24lm	—	10/600	PA
FCY-SBK24	190096192748	912401592595	FCY Linear HB Surf Brckt kit 15lm & 24lm	—	20/1440	PA
FCY-WG36	190096192755	912401592596	FCY Linear HB Wire Guard 36lm	—	20/2100	PA
FCY-PENHGR36	190096192762	912401592597	FCY Linear HB Pendant Hanger Kit 36lm	—	78/3900	PA
FCY-SBK36	190096192779	912401592598	FCY Linear HB Surface Bracket kit 36lm	—	120/5760	PA



DSRT

Combine robust construction, a slim design, and low glare for versatile applications.



Why choose DSRT Gen2?

- Robust low glare luminaire with or without sensor
- 3 lumen and 3 CCT field selectable options per size.
- Available for use in recessed, suspended and surface mount applications.



DSRT LED

Catalog Number	UPC Code	Model Number	Product Description	Compliance	C/P Qty	Distr. Ctr.
DSRT Selectable Troffer						
1DSRT3050LCS-4-UNV-DIM	190096197118	911401810587	1x4, Lumen Select, 80CRI, Color Select (3500K/4000K/5000K), UNV 120-277V, 0-10V	DLC Premium	1/30	PA, CA, TN, IL
1DSRT3050LCS-4-UNV-DIM-DAYOCC	190096197163	911401821487	1x4, Lumen Select, 80CRI, Color Select (3500K/4000K/5000K), UNV 120-277V, 0-10V, DAYOCC Sensor	DLC Premium	1/30	PA, CA, TN, IL
2DSRT3050LCS-2-UNV-DIM	190096197125	911401810687	2x2, Lumen Select, 80CRI, Color Select (3500K/4000K/5000K), UNV 120-277V, 0-10V	DLC Premium	1/20	PA, CA, TN, IL
2DSRT3050LCS-2-UNV-DIM-DAYOCC	190096197170	911401821587	2x2, Lumen Select, 80CRI, Color Select (3500K/4000K/5000K), UNV 120-277V, 0-10V, DAYOCC Sensor	DLC Premium	1/20	PA, CA, TN, IL
2DSRT4060LCS-4-UNV-DIM	190096197132	911401810787	2x4, Lumen Select, 80CRI, Color Select (3500K/4000K/5000K), UNV 120-277V, 0-10V	DLC Premium	1/12	PA, CA, TN, IL
2DSRT4060LCS-4-UNV-DIM-DAYOCC	190096197187	911401821687	2x4, Lumen Select, 80CRI, Color Select (3500K/4000K/5000K), UNV 120-277V, 0-10V, DAYOCC Sensor	DLC Premium	1/10	PA, CA, TN, IL
DSRT Accessories						
1DSRT-4-SKT	190096197255	911401838887	1x4 DSRT Surface Kit	—	10/100	PA
2DSRT-2-SKT	190096197262	911401838987	2x2 DSRT Surface Kit	—	10/200	PA
2DSRT-4-SKT	190096197279	911401839087	2x4 DSRT Surface Kit	—	10/100	PA
DSRT-CKT-NP	190096197231	911401838687	DSRT Suspension Kit no Power	—	500/500	PA
DSRT-CKT-WP	190096197248	911401838787	DSRT Suspension Kit with Power	—	40/1080	PA

1. Visit signify.com/warranties for full warranty information.





Selectable Backlit Panel

Make the **easy selection** and carry less stock with more options.



Why choose Selectable Backlit Panel?

- 3 color temperature selections, 3 wattage choices, and 3 sizes available
- Numerous options for your customers, while keeping inventory levels and SKU count low
- Available for use in recessed, suspended and surface mount applications

Selectable Backlit Panel LED select

Catalog Number	UPC Code	Model No.	Product Description	Compliance	C/P Qty	Distr. Ctr.
Selectable Backlit Panel (30W/34W/39W)						
1SBP3040L8CS-4-UNV-DIM	190096130993	911401837681	1x4, Lumen Select, 80CRI, Color Select (3500K/4000K/5000K), UNV 120-277V, 0-10V	DLC Standard	4/24	CA, TN, PA, IL
2SBP3040L8CS-2-UNV-DIM	190096131006	911401837781	2x2, Lumen Select, 80CRI, Color Select (3500K/4000K/5000K), UNV 120-277V, 0-10V	DLC Standard	4/24	CA, TN, PA, IL, GA*
2SBP3550L8CS-4-UNV-DIM	190096131013	911401837881	2x4, Lumen Select, 80CRI, Color Select (3500K/4000K/5000K), UNV 120-277V, 0-10V	DLC Standard	4/12	CA, TN, PA, IL, GA*
1SBP3040L8CS-4-UNV-DIM-BSL310RM	—	912401608892	1x4, Lumen Select, 80CRI, Color Select (3500K/4000K/5000K), UNV 120-277V, 0-10V, w/10W EM Factory Install	—	—	PA, CA
2SBP3040L8CS-2-UNV-DIM-BSL310RM	784197708290	912401608896	2x2, Lumen Select, 80CRI, Color Select (3500K/4000K/5000K), UNV 120-277V, 0-10V, w/10W EM Factory Install	—	—	TN, PA, CA
2SBP3550L8CS-4-UNV-DIM-BSL310RM	784197708306	912401608901	2x4, Lumen Select, 80CRI, Color Select (3500K/4000K/5000K), UNV 120-277V, 0-10V, w/10W EM Factory Install	—	—	TN, PA, CA
Selectable Backlit Panel Accessories						
FPEMLED10RM	784197707941	912401608930	Emergency LED driver, Class 2, 10W, compatible with SBP / NWL / SDS / FCY	—	1/120	TN PA CA GA IL
FSF24	784197614386	912401457671	2'x4' surface mount field installation kit (field assembled)	—	—	TN, IL
FSF22	784197614379	912401457672	2'x2' surface mount field installation kit (field assembled)	—	—	TN, IL

* Will Call (pickup only)



FluxPanel gen 2

Uniform surface of light provides low glare, flicker free lighting at an affordable price.



Why choose FluxPanel Gen2?

- DLC standard and premium options to assure performance and maximum ROI
- Tested TM21 prediction L70 up to 90,000 hrs and warranted for 5 years¹
- Install the remote mount sensor accessory to capture maximum savings now and expand the network for add on sales and value in the future
- Flexible wiring options
- Available with factory installed BSL10LST self test 10W and BSL6LST self test 6W ...more lumen output for 1 watt less



FluxPanel LED

Catalog Number	UPC Code	Model Number	Product Description	Compliance	C/P Qty	Distr. Ctr.
FluxPanel						
1FPZ38B835-4-DS-UNV-DIM	190096180011	912401587017	1x4, 3800lm, 80CRI, 3500K, Smooth Diffuser, UNV 120-277V, 0-10V	DLC Standard	1/40	TN
1FPZ38B840-4-DS-UNV-DIM	190096180028	912401609016	1x4, 3800lm, 80CRI, 4000K, Smooth Diffuser, UNV 120-277V, 0-10V	DLC Standard	1/40	CA
2FPZ20L835-2-DS UNV DIM	190096180769	912401591598	2x2, 2000lm, 80CRI, 3500K, Smooth Diffuser, UNV 120-277V, 0-10V	DLC Premium	1/40	PA
2FPZ20L840-2-DS UNV DIM	190096180776	912401591599	2x2, 2000lm, 80CRI, 4000K, Smooth Diffuser, UNV 120-277V, 0-10V	DLC Premium	1/40	PA
2FPZ20L850-2-DS UNV DIM	190096181902	912401591705	2x2, 2000lm, 80CRI, 5000K, Smooth Diffuser, UNV 120-277V, 0-10V	DLC Premium	1/40	PA
2FPZ30L835-2-DS UNV DIM	190096180783	912401591601	2x2, 3000lm, 80CRI, 3500K, Smooth Diffuser, UNV 120-277V, 0-10V	DLC Premium	1/40	PA
2FPZ30L840-2-DS UNV DIM	190096180790	912401591602	2x2, 3000lm, 80CRI, 4000K, Smooth Diffuser, UNV 120-277V, 0-10V	DLC Premium	1/40	PA
2FPZ38B835-2-DS-UNV-DIM	190096180035	912401609018	2x2, 3800lm, 80CRI, 3500K, Smooth Diffuser, UNV 120-277V, 0-10V	DLC Standard	1/40	CA, TN, PA
2FPZ38B840-2-DS-UNV-DIM	190096180042	912401609019	2x2, 3800lm, 80CRI, 4000K, Smooth Diffuser, UNV 120-277V, 0-10V	DLC Standard	1/40	CA, TN, PA, IL
2FPZ38B850-2-DS-UNV-DIM	784197708160	912401609020	2x2, 3800lm, 80CRI, 5000K, Smooth Diffuser, UNV 120-277V, 0-10V	DLC Standard	1/40	CA, TN, PA
2FPZ30L835-4-DS UNV DIM	190096180806	912401591603	2x4, 3000lm, 80CRI, 3500K, Smooth Diffuser, UNV 120-277V, 0-10V	DLC Premium	1/20	PA
2FPZ30L840-4-DS UNV DIM	190096180813	912401591604	2x4, 3000lm, 80CRI, 4000K, Smooth Diffuser, UNV 120-277V, 0-10V	DLC Premium	1/20	PA
2FPZ30L850-4-DS UNV DIM	190096181919	912401591706	2x4, 3000lm, 80CRI, 5000K, Smooth Diffuser, UNV 120-277V, 0-10V	DLC Premium	1/20	Factory
2FPZ38L835-4-DS UNV DIM	190096180837	912401591606	2x4, 3800lm, 80CRI, 3500K, Smooth Diffuser, UNV 120-277V, 0-10V	DLC Premium	1/20	PA
2FPZ38L840-4-DS UNV DIM	190096180820	912401591605	2x4, 3800lm, 80CRI, 4000K, Smooth Diffuser, UNV 120-277V, 0-10V	DLC Premium	1/20	PA
2FPZ42B835-4-DS-UNV-DIM	190096180066	912401609021	2x4, 4200lm, 80CRI, 3500K, Smooth Diffuser, UNV 120-277V, 0-10V	DLC Standard	1/20	CA, TN, PA
2FPZ42B840-4-DS-UNV-DIM	190096180073	912401609022	2x4, 4200lm, 80CRI, 4000K, Smooth Diffuser, UNV 120-277V, 0-10V	DLC Standard	1/20	CA, TN, PA, IL
2FPZ42B850-2-DS-UNV-DIM	784197708283	912401609023	2x2, 4200lm, 80CRI, 5000K, Smooth Diffuser, UNV 120-277V, 0-10V	DLC Standard	1/40	CA, TN, PA
FluxPanel Accessory						
FSF24	784197614386	912401457671	2'x4' surface mount field installation kit (field assembled)	-	-	TN, IL
FSF22	784197614379	912401457672	2'x2' surface mount field installation kit (field assembled)	-	-	TN, IL

1. Visit signify.com/warranties for full warranty information.

Field Emergency Kit (FPEM)

Ideal for renovations and new construction opportunities where remote mounting is a necessity.

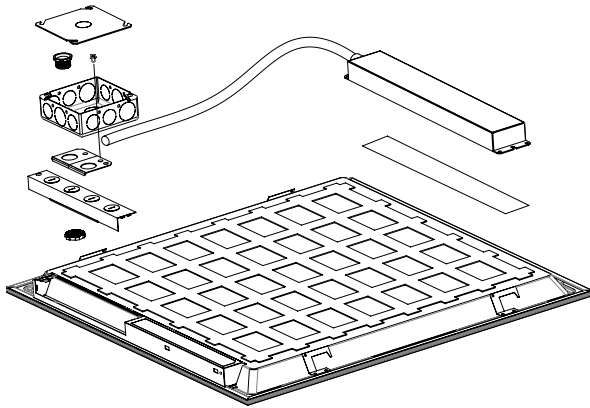





Why choose FPEM?

- A simple, time saving solution for emergency remote mounting applications
- Designed for use with several configurations of panels, wraps, and strips product families
- Operates an LED load of up to 10.4 W at nominal battery voltage for a minimum of 90 minutes
- Indicator test switch and plate mounting compatibility with grid ceiling, drywall, or open ceiling application

Field Emergency Kit (FPEM)

Catalog Number	UPC Code	Model Number	Product Description	Case/Pallet Qty	Distribution Center
FluxPanel Gen2					
FPEMLED10RM	784197707941	912401608930	Emergency LED driver, Class 2, 10W, compatible with Selectable Panel / NWL Wrap / SDS Strip / FCY	1/120	CA, TN, PA

Product families compatible with the FPEM

FluxPanel SBP	FluxPanel FPZ	NWL Wraparound	SDS LED
FluxPanel Selectable LED flat panel	FluxPanel Gen2 LED flat panel	NWL Wraparound LED	SDS LED Selectable Strip
			



NWL Selectable Wraparound

Achieve a balance of performance and appeal



NWL
(Wraparound)
with field on/off
occupancy sensor

Why choose NWL Selectable Wraparound?

- White polycarbonate housing for durability
- Frosted polycarbonate lens for even, low glare lighting
- Hardware for surface mounting included
- Field CCT selectable for 3000K, 3500K or 4000K
- cETLus listed to meet UL 1598 standards for -10°C to 35°C ambient. Suitable for damp locations



NWL Selectable Wraparound LED select

Catalog Number	UPC Code	Model No.	Product Description	Compliance	C/P Qty	Distr. Ctr.
NWL						
NWL21525L8CST-UNV-DIM	190096196883	911401893085	2' Length, 15/20/25lm, 80CRI, Color Select 3000K-3500K-4000K, UNV 120-277V, 0-10V, Occupancy sensor	DLC Standard	4/64	CA, TN, PA
NWL43050L8CST-UN3-DIM	190096196890	911401893185	4' Length, 30/40/50lm, 80CRI, Color Select 3000K-3500K-4000K, UN3 120-347V, 0-10V, Occupancy sensor	DLC Premium	4/32	CA, TN, PA
NWL860100L8CST-UN3-DIM	190096196906	911401893285	8' Length, 60/80/100lm, 80CRI, Color Select 3000K-3500K-4000K, UN3 120-347V, 0-10V, Occupancy sensor	DLC Premium	1/45	CA, TN, PA
NWL Accessories						
FPEMLED10RM	784197707941	912401608930	Emergency LED driver, Class 2, 10W, compatible with SBP / NWL / SDS / FCY	—	1/120	TN PA CA GA IL
HNH5-VHOOK	784197658762	912401459117	54" Chains & V Brackets	—	12/2160	TN, GA
HCH10-VHOOK	784197658731	912401459114	10' Cables & V Brackets	—	5/600	TN, GA
HCH5-VHOOK	784197658724	912401459113	5' Cables & V Brackets	—	10/600	IL, TN, GA



SDS
(Selectable Strip)

SDS Selectable Strip

Economical luminaire
delivering the right light



Why choose SDS Selectable LED Strip?

- Simple form
- Convenient specification
- Ease of installation
- Ease of maintenance
- Durable construction
- Simple mounting method
- Frosted glare-free lens
- CCT & Lumen selectability

SDS Selectable Strip LED dual select

Catalog Number	UPC Code	Model Number	Product Description	Compliance	Case/Pallet Qty	Distribution Center
SDS Linear Strip						
SDS21224L8CST-UNV-DIM	190096131563	911401870782	Linear Strip DS 2ft/ 35-40-50K/UNV	DLC Standard	9/450	PA, CA, TN, IL
SDS42448L8CST-UNV-DIM	190096131570	911401870882	Linear Strip DS 4ft/ 35-40-50K/UNV	DLC Standard	9/225	PA, CA, TN, IL GA
SDS84998L8CST-UNV-DIM	190096131587	911401870982	Linear Strip DS 8ft/ 35-40-50K/UNV	DLC Standard	6/210	PA, CA, TN, IL GA
SDS Linear Strip Accessories						
FPEMLED10RM	784197707941	912401608930	Emergency LED driver, Class 2, 10W, compatible with SBP / NWL / SDS / FCY		1/120	TN PA CA GA IL



VTS Sealed Strip

Dual selectable sealed strip for indoor and outdoor applications

Sealed Strip luminaire offers rugged reliability, selectability and the efficiency your successful business requires.



Why choose VTS Sealed Strip?

- Ideally suited for use in refrigerated cold storage, industrial, parking garage, and canopy applications.
- Acceptable for outdoor as well as indoor installations.
- Can be surface mounted on ceilings or walls, or suspended via brackets, chain or cables (2ft, 4ft or 8ft option).
- Selectable (3500, 4000 or 5000K) default setting is 4000K correlated color temperature (CCT) with max available power.



VTS Sealed Strip LED dual select

Catalog Number	UPC Code	Model Number	Product Description	Compliance	Case/Pallet Qty	Distribution Center
VTS Sealed Strip						
VTS225L840-UN3-DIM	190096196562	911401827085	2ft 2500lm 4000K 120-347V	DLC Standard	6/144	PA
VTS22028L8CST-UN3-DIM	190096196517	911401824985	2ft 20/24/28lm 3CCT 120-347V	DLC Standard	6/144	PA
VTS450L840-UN3-DIM	190096196524	911401825085	4ft 5000lm 4000K 120-347V	DLC Standard	4/64	PA
VTS42856L8CST-UN3-DIM	190096196531	911401825185	4ft 28/42/56lm 3CCT 120-347V	DLC Standard	4/64	TN PA GA
VTS8100L840-UN3-DIM	190096196548	911401825285	8ft 10000lm 4000K 120-347V	DLC Standard	2/64	PA
VTS880130L8CST-UN3-DIM	190096196555	911401825385	8ft 80/110/130lm 3CCT 120-347V	DLC Standard	2/64	TN PA GA



Value+ LED Exit Signs

Basic exit that offers a low profile design, giving it stylish appeal suitable for any general purpose application.



Why choose Value+ Family?

- Thermoplastic (off white) ABS housing
- Low profile, snap together quick mount design
- Universal wall/ceiling/end mounting
- UL damp location listed
- Pop out chevron directional indicators are easily removed when required
- Extra stencil faceplate for double face sign applications
- 6V maintenance free nickel cadmium battery

Value+ LED Exit Signs

Catalog Number	UPC Code	Model Number	Product Description	C/P Qty	Distribution Center
Value+ Exit Signs					
VEGW	782343263020	912400348806	Universal Mount, Green Letters, White Thermoplastic Housing, AC Only	12/144	CA
VEGWEM	782343263044	912400348808	Universal Mount, Green Letters, White Thermoplastic Housing, Nicad battery	12/288	CA, TN, PA
VERW	782343263006	912400348805	Universal Mount, Red Letters, White Thermoplastic Housing, AC Only	12/384	CA, TN
VERWEM	782343263037	912400348807	Universal Mount, Red Letters, White Thermoplastic Housing, Nicad battery	12/288	CA, TN, PA, IL, GA*

* Will Call (pickup only)



Value+ LED Emergency Units

General purpose emergency product that features a low profile design giving it a stylish appeal suitable for any general purpose application.



Why choose Value+ Family?

- Wall, ceiling and surface mounting provisions
- Long life LED lamps
- 3.6V maintenance free nickel cadmium battery
- UL damp location listed



Value+ LED Emergency Units

Cat. No.	UPC Code	Model Number	Product Description	C/P Qty	Distr. Ctr.
Value+ Exit/Emergency Combo Unit					
VLLCR	784197043865	912401289503	3.6V and (2) 1 watt LED lamps, no remote capability, Red letters, white housing	12/324	CA, TN, PA, IL
VLLCR2R	784197043872	912401289504	3.6V and (2) 1 watt LED lamps, remote head capability, Red letters, white housing	12/324	CA, TN, PA, IL
VLLCG2R	784197043902	912401289507	3.6V and (2) 1 watt LED lamps, remote head capability, Green letters, white housing	12/324	CA, GA
VLTCR3R	784197302368	912401461342	3.6V and (2) 1 watt LED lamps, remote head capability (2-1W or 1-2W lamp heads), Red letters, white housing	4/4	CA, TN, PA
Value+ Emergency Unit					
VLLU	784197038342	912401289498	Round, 3.6V and (2) 1 watt LED lamps, no remote capability, white housing	12/96	CA, TN, PA, IL, GA*
VLLU2	784197043858	912401289502	Round, 3.6V and (2) 2 watt LED lamps, no remote capability, white housing	12/96	CA, TN, PA
VLLUR	784197043834	912401289499	Round, 3.6V and (2) 1 watt LED lamps, remote head capability, white housing	12/96	TN, PA
VLTU	784197302290	912401461338	Square, 3.6V and (2) 1 watt LED lamps, no remote capability, white housing	6/6	CA, TN, PA
VLTUR	784197302306	912401461339	Square, 3.6V and (2) 1 watt LED lamps, remote head capability (201W or 1-2W heads), white housing	6/6	CA, GA*
Value+ Emergency Unit Remote Lamp Heads					
VLL1R	784197043926	912401289509	Single round indoor remote head, 3.6V and (1) 1 watt LED lamp, off-white housing	24/960	TN, GA
VLL2R	784197043933	912401289510	Double round indoor remote head, 3.6V and (2) 1 watt LED lamp, off-white housing	24/960	CA, TN, GA*
VL1R	784197302344	912401461341	Single square indoor remote head, 3.6V and (1) 1 watt LED lamp, off-white housing	12/12	Factory
VL2R	784197302276	912401461410	Double square indoor remote head, 3.6V and (2) 1 watt LED lamp, off-white housing	6/6	CA
VLL1RGO	190096191451	912401592119	Single square outdoor remote head, 3.6V, 6V, 9.6V, or 12V and (1) 1 watt LED lamp, gray housing	12/360	CA
VLL2RGO	190096191468	912401592120	Single square outdoor remote head, 3.6V, 6V, 9.6V, or 12V and (2) 1 watt LED lamp, gray housing	6/150	CA, TN, PA, IL

* Will Call (pickup only)





All sizes arrive fully assembled and ready to install

SlimFlood

Fade-resistant, textured bronze finish with tempered glass lens that is heat and impact resistant



Why choose Slim Flood dual select?

- Complete family of LED floodlights ideal for illuminating signs, building facades or other dark areas
- Can be mounted on the ground, wall, or pole mounted
- Field selectable CCT of 3000–5000K
- Field selectable wattages 10–300W with 7 housing sizes & 4 mountings
- Photo Cell included 35–150W, Photo Cell option 205 & 300W
- IP65 rated, 5-year limited warranty¹

SlimFlood LED dual select

Catalog Number	UPC Code	Model No.	Product Description	Compliance	C/P Qty	Distr. Ctr.
SlimFlood dual select - Bronze Finish						
SF100-SCT-S-G2-10-PCB-BZ	190096196067	911401874984	Slim Flood Dual Select 100W Max, 3CCT, UNV, Slip Fitter, PCB	DLC Premium	1/60	TN, CA, PA
SF100-SCT-T-G2-10-PCB-BZ	190096196074	911401875084	Slim Flood Dual Select 100W Max, 3CCT, UNV, Trunion, PCB	DLC Premium	1/90	TN, CA, PA
SF150-SCT-S-G2-10-PCB-BZ	190096196081	911401875184	Slim Flood Dual Select 150W Max, 3CCT, UNV, Slip Fitter, PCB	DLC Premium	1/40	TN, CA, PA
SF150-SCT-T-G2-10-PCB-BZ	190096196098	911401875284	Slim Flood Dual Select 150W Max, 3CCT, UNV, Trunion, PCB	DLC Premium	1/40	TN, CA, PA
SF15-SCT-K-G2-10-BZ	190096196005	911401874384	Slim Flood Dual Select 15W Max, 3CCT, UNV, Knuckle	DLC Premium	1/180	TN, CA, PA
SF15-SCT-Y-G2-10-BZ	190096196012	911401874484	Slim Flood Dual Select 15W Max, 3CCT, UNV, Yoke	DLC Premium	1/300	TN, CA, PA
SF205-SCT-S-G2-10-BZ	190096196104	911401875384	Slim Flood Dual Select 205W Max, 3CCT, UNV, Slip Fitter, PCB	DLC Premium	1/24	TN, CA, PA
SF205-SCT-T-G2-10-BZ	190096196111	911401875484	Slim Flood Dual Select 205W Max, 3CCT, UNV, Trunion, PCB	DLC Premium	1/24	TN, CA, PA
SF300-SCT-S-G2-10-BZ	190096196128	911401875584	Slim Flood Dual Select 300W Max, 3CCT, UNV, Slip Fitter, PCB	DLC Premium	1/20	TN, CA, PA
SF300-SCT-T-G2-10-BZ	190096196135	911401875684	Slim Flood Dual Select 300W Max, 3CCT, UNV, Trunion, PCB	DLC Premium	1/20	TN, CA, PA
SF35-SCT-K-G2-10-PCB-BZ	190096196029	911401874584	Slim Flood Dual Select 35W Max, 3CCT, UNV, Knuckle	DLC Premium	1/180	TN, CA, PA
SF35-SCT-Y-G2-10-PCB-BZ	190096196036	911401874684	Slim Flood Dual Select 35W Max, 3CCT, UNV, Yoke	DLC Premium	1/240	TN, CA, PA
SF60-SCT-K-G2-10-PCB-BZ	190096196043	911401874784	Slim Flood Dual Select 60W Max, 3CCT, UNV, Knuckle	DLC Premium	1/120	TN, CA, PA
SF60-SCT-Y-G2-10-PCB-BZ	190096196050	911401874884	Slim Flood Dual Select 60W Max, 3CCT, UNV, Yoke	DLC Premium	1/120	TN, CA, PA
SF205-300-PCB	190096196142	911401875784	Slim Flood, 120–150–205W PCB Accessory	DLC Premium	—	TN, CA, PA

1. See www.signify.com/warranties for details.

Wall Pack LED dual select

Classic design meets LED technology

The new Wall Pack dual select helps you upgrade from costly HID fixtures with confidence.



Why choose Wall Pack?

- An easy switch from costly HID fixture
- Field selectable wattage and color temperature
- Flexible options, built-in photocell, and field enable or disable
- Glass refractor lens design cuts down on glare



Wall Pack LED dual select

Catalog Number	UPC Code	Model Number	Product Description	Compliance	C/P Qty	Distribution Center
Wall Pack dual select - Bronze Finish						
WP100-SCT-G2-10-BZ	190096131341	911401872481	Selectable Wattage & CCT, 80-100W / 30K-40K-50K, Bronze	DLC Premium	24-Feb	CA, TN, PA, IL, GA*
WP60-SCT-G2-10-BZ	190096131334	911401872381	Selectable Wattage & CCT, 28-40-60W / 30K-40K-50K, Bronze	DLC Premium	44981	CA, TN, PA, IL, GA*
WP100-SCT-G2-10-WH	190096196814	911401871085	Selectable Wattage & CCT, 80-100W / 30K-40K-50K, White	DLC Premium	2/24	PA
WP60-SCT-G2-10-WH	190096196807	911401870985	Selectable Wattage & CCT, 28-40-60W / 30K-40K-50K, White	DLC Premium	2/24	PA



Adj. Slim Wall Pack LED dual select

Slim, low profile LED design

Features a discreet design that will complement any building exterior. Two sizes are available, with three wattage and three CCT selectable options each.



Why choose Adjustable Slim Wall Pack?

- Wall, surface, low level mounting
- Die-cast aluminum, hinged
- Simplified solution – dual select
- 2 housing sizes (25W & 75W)
 - 25W (15/20/25W & 1800/2400/3000 lms)
 - 75W (45/60/75W & 5400/7200/9000 lms)
- CCT Selectable (3K/4K/5K) & 120-277V
- IP65 / IK07 Rated / DLC 5.1
- Button Photocontrol w/0-90° tilt option

Adjustable Slim Wall Pack LED dual select

Catalog Number	UPC Code	Model Number	Product Description	Compliance	Case/Pallet Qty	Distribution Center
Adjustable Slim Wall Pack						
ASW25-SCT-G1-8-PCB-BW	190096182039	912401591885	Adj Slim WP DS 15-25W/30-40-50K/UNV/PCB	–	4/144	TN, CA, PA
ASW75-SCT-G1-8-PCB-BW	190096182046	912401591886	Adj Slim WP DS 45-75W/30-40-50K/UNV/PCB	–	4/120	TN, CA, PA



Residential Wall Pack LED select

Boasts a discreet design that seamlessly complements any building exterior

One SKU provides three wattage options and three CCT selectable choices.



Why choose Residential Wall Pack?

- Low-profile design to complement and blend in with surroundings
- Provides energy saving replacement for incandescent, compact fluorescent and HID lamp sources
- Easily mounts to a variety of junction box types or fastens directly to wall for seamless retrofitting
- Outstanding long life provides maintenance savings



Wall Pack LED dual select

Catalog Number	UPC Code	Model Number	Product Description	Compliance	Case/Pallet Qty	Distribution Center
Wall Pack dual select - Bronze Finish						
RWP30-SCT-G1-10-BZ	190096197224	911401822487	Residential Wall Pack 30W/30-40-50K BZ	DLC Standard	1/60	PA



Lytepro Area

General purpose arm mount

LytePro Area (LPA) pole-mounted LED luminaire is a value-engineered solution with the perfect combination of affordability, quality, and performance.



Why choose Lytepro area?

- Mounting to Round or Square Pole without need for accessories.
- Large bolt spacing range for easy retrofit application.
- Lumen output range from 2,500 to 29,000 with efficacies up to 185 LPW
- Button or twist-lock photocell, motion response, and field adjustable wattage
- IES Distribution Types 2, 3, 4, & 5
- 3000k, 4000k, and 5000K CCTs.
- All models are DLC qualified.
- 5 year limited warranty

Lytepro Area

Catalog Number	UPC Code	Model No.	Product Description	Compliance	C/P Qty	Distr. Ctr.
Lytepro Area - Bronze Finish						
LPA-A06-740-T3-UNV-FAWS-TRPC-BZ	190096192953	912300004181	12,000lm, 70CRI, 4000K, Type 3, 120-277V, Selectable Wattage, 7-pin with 0-10v short cap	DLC Standard	1/24	PA
LPA-A06-740-T4-UNV-FAWS-TRPC-BZ	190096192960	912300004183	12,000lm, 70CRI, 4000K, Type 4, 120-277V, Selectable Wattage, 7-pin with 0-10v short cap	DLC Standard	1/24	PA
LPA-A11-740-T3-UNV-FAWS-TRPC-BZ	190096192977	912300004185	29,000lm, 70CRI, 4000K, Type 3, 120-277V, Selectable Wattage, 7-pin with 0-10v short cap	DLC Standard	1/24	PA
LPA-A11-740-T4-UNV-FAWS-TRPC-BZ	190096192984	912300004187	29,000lm, 70CRI, 4000K, Type 4, 120-277V, Selectable Wattage, 7-pin with 0-10v short cap	DLC Standard	1/24	PA



GENLYTE SOLUTIONS

a gnify business

© 2024 Signify Holding. All rights reserved. The information provided herein is subject to change, without notice. Signify does not give any representation or warranty as to the accuracy or completeness of the information included herein and shall not be liable for any action in reliance thereon. The information presented in this document is not intended as any commercial offer and does not form part of any quotation or contract, unless otherwise agreed by Signify.

Signify North America Corp.
400 Crossing Blvd, Suite 600
Bridgewater, NJ 08807
Telephone: 800-555-0050

Signify Canada Ltd.
281 Hillmount Road,
Markham, ON, Canada L6C 2S3
Telephone: 800-668-9008

All trademarks are owned by Signify Holding or their respective owners.